



Altitude<sup>32</sup>

# User manual

Software version v4.2.11





Thank you for choosing Trinnov Audio

# ALTITUDE<sup>32</sup> USER GUIDE

Software version v4.2.11

Last update: May, 2019

# SUMMARY

NOTICES	8
---------	---

IMPORTANT SAFETY INSTRUCTIONS	9
-------------------------------	---

INTRODUCTION	10
--------------	----

1.1 _ABOUT THIS GUIDE	12
1.2 _PRODUCT INFORMATION	14
1.3 _SYSTEM INTEGRATION	15
1.4 _TRINNOV CERTIFIED INSTALLERS	15
1.5 _UNPACKING THE ALTITUDE <sup>32</sup>	16
1.6 _THE HARDWARE	17
1.6.1 _Front panel layout	17
1.6.2 _Front panel display	17
1.6.3 _Rear panel layout	18
1.6.4 _IR remote control	19
1.7 _THE SOFTWARE	20
1.7.1 _Available options to access the graphical user interface	20
1.7.2 _IMPORTANT NOTE ABOUT THE WEB-BASED INTERFACE	20
1.7.3 _Using a display, mouse and keyboard connected to the Altitude <sup>32</sup>	21
1.7.4 _The Top menu bar	21
1.7.6 _The side menu bar	22
1.7.8 _UNFolded lateral menu	24
1.7.9 _The Speakers/Room setup tool	25
1.7.10 _The Fine Tuning panel	25
1.7.11 _The Advanced Settings interface	26
1.7.12 _Product Information	26

2 _NETWORK SETUP	28
------------------	----

2.1 _CONNECTING TO THE Altitude <sup>32</sup>	28
2.1.1 _OVERVIEW OF THE NETWORK CONNECTION PROCEDURE	28
2.1.2 _STEP 1: DOWNLOAD AND INSTALL A VNC CLIENT ON YOUR DEVICE	29
2.1.2.1 _USING A TABLET	29
2.1.2.2 _Using a Mac OS X computer	29
2.1.2.3 _Using a WINDOWS computer	29

2.1.3 _Step 2: put the Altitude <sup>32</sup> and your device on the same network	30
2.1.4 _STEP 3: CONNECT TO THE Altitude <sup>32</sup> FROM YOUR DEVICE	30
2.1.4.1 _USING A TABLET WITH MOCHA VNC LITE	30
2.1.5 _USING A MAC OS X COMPUTER WITH the Trinnov App	31
2.1.7 _USING A MAC OS X COMPUTER WITH CHICKEN OF THE VNC	33
2.1.8 _USING A WINDOWS COMPUTER WITH TIGHT VNC	33
WRITE DOWN YOUR Altitude <sup>32</sup> 'S SERIAL NUMBER	33
Write down the IP address of the Altitude <sup>32</sup>	34
GETTING THE IP ADDRESS FROM THE ETHERNET SETTINGS	34
Connect with Tight VNC	34

2.2 _CHANGING THE NETWORK SETTINGS THROUGH THE FRONT PANEL	35
2.2.1 _Checking the Wi-Fi settings	35
2.2.2 _USING DHCP	35
2.3 _CHANGING THE ETHERNET SETTINGS THROUGH THE GUI	35
2.3.1 _ABOUT THE ETHERNET INFORMATION	35
2.3.2 _CHECKING THE ETHERNET SETTINGS	36
2.3.3 _CHANGING THE ETHERNET SETTINGS	36
2.4 _ABOUT VNC AND ZERO-CONF NETWORKING	37
2.4.1 _ABOUT VNC (VIRTUAL NETWORK COMPUTING)	37
2.4.2 _ABOUT ZERO-CONFIGURATION NETWORKING	37

3 _NETWORK STREAMING	38
----------------------	----

3.1 _THE UPNP PROTOCOL	38
3.2 _UPNP NETWORK ARCHITECTURE	38
3.3 _RECOMMENDED UPNP SOFTWARES	39
3.4 _USING ROON	40
3.4.1 _Getting Started with Roon	40
3.4.2 _Important recommendation	41
3.4.3 _Altitude <sup>32</sup> is Roon Ready	42

4 _DAILY OPERATIONS	43
---------------------	----

4.1 _AVAILABLE USER INTERFACES	43
4.2 _USING THE FRONT PANEL	43
4.2.1 _Power On-Off Sequence	43
4.2.2 _Checking the format of incoming audio	45
4.3 _USING THE IR REMOTE CONTROL	46
4.3.1 _VOLUME CONTROL	46

4.3.2 _Source selection .....	46	6.3.12.4 _Load a PEQ group .....	77
4.3.3 _Listening format Selection .....	46	6.3.12.5 _Delete a PEQ group .....	78
4.3.4 _Preset selection .....	46	6.3.12.6 _SAVE A PEQ GROUP ON AN EXISTING ONE .....	79
4.3.5 _ACCESS TO THE FRONT PANEL MENU .....	47	If an existing EQ group needs modification, it is possible to overwrite it with the new parameters. To do so, please follow this procedure: .....	79
4.3.6 _Light Button .....	47	6.3.12.7 _GENERATE PINK NOISE .....	80
4.3.7 _Optimizer Bypass .....	47		
4.4 _USING THE GRAPHICAL INTERFACE .....	48	6.4.13 _SETTING UP AN ARRAY OF SPEAKERS .....	80
4.4.1 _Volume control .....	48	6.3.13.1 _EXAMPLE OF AN ARRAY OF SPEAKERS .....	81
4.4.2 _Source selection .....	48	6.3.13.2 _ADJUST THE GAIN .....	81
4.4.3 _Preset selection .....	49		
4.4.4 _Checking the format of incoming audio .....	49	6.4 _SETUP BASS MANAGEMENT .....	82
		6.4.1 _OVERVIEW OF THE BASS MANAGEMENT SETUP PROCEDURE .....	83
5 _BASIC SETTINGS .....	50	6.4.2 _BASS MANAGEMENT MODE .....	84
5.1 _NAMING YOUR SOURCES .....	50	6.4.3 _QUICK SETUP MENU .....	86
5.2 _CONFIGURING YOUR SOURCES .....	51	6.4.3.1 _SET FILTERS .....	87
5.3 _DEFAULT SOURCE CONFIGURATION .....	53	6.4.3.2 _APPLY TO SELECTED SPEAKERS .....	87
5.4 _OPTIMIZATION OPTIONS .....	54	6.4.4 _INDIVIDUAL SETUP MENU .....	87
5.5 _REMAPPING OPTIONS .....	55	6.4.4.1 _REGULAR BASS MANAGEMENT .....	87
5.6 _NAMING, SAVING AND LOADING PRESETS .....	55	6.4.4.2 _INTERMEDIATE BASS MANAGEMENT .....	88
5.7 _DEFAULT PRESET .....	57	6.4.5 _LFE & MISC .....	90
5.8 _SET A MAXIMUM VOLUME .....	58	6.4.5.1 _LOW FREQUENCY EFFECT SETUP .....	90
5.9 _SET THE DIM LEVEL .....	59	6.4.5.2 _REDIRECT LFE CHANNEL TO ONE OR MORE SATEL- LITE(S) 90 .....	91
5.10 _BACKUP/RESTORE CONFIGURATIONS .....	60	6.4.5.3 _+10 DB ON LFE .....	91
		6.4.5.4 _STACKED SUB CORRECTION .....	91
6 _QUICK SETUP .....	61	6.5 _USING TRINNOV 3D MICROPHONE .....	92
6.1 _STARTING THE WIZARD .....	61	6.5.1 _THEORETICAL REQUIREMENTS FOR THE MEASUREMENT ENVIRONMENT .....	92
6.2 _DEFINE YOUR PRESET .....	62	6.5.2 _REFERENCE MEASUREMENT POINT .....	93
6.3 _SETUP YOUR ROOM .....	63	6.5.3 _POSITION AND ORIENTATION OF THE MICROPHONE FOR THE REFERENCE POINT .....	93
6.3.1 _Introducing the Speaker/Room setup tool .....	63	6.6 _SETTING THE VOLUME FOR THE CALIBRATION .....	94
6.3.2 _An example of a specific speaker layout .....	65	6.7 _SETTING THE CROSSOVERS (OPTIONAL) .....	96
6.3.3 _Available initial layouts .....	66	6.7.1 _OVERVIEW OF THE CROSSOVER SETUP PROCEDURE .....	97
6.3.4 _Select an initial speaker layout .....	66	6.7.2 _ACTIVE FILTERS AUTO CALIBRATION .....	98
6.3.5 _Adding Regular Speakers .....	68	6.7.3 _ACTIVE FILTERS MANUAL CALIBRATION (EXPERTS ONLY) ... 99 .....	99
6.3.6 _Adding Dolby Enabled Upfiring speakers .....	69	6.7.3.1 _SETTING THE CROSSOVERS .....	99
6.3.7 _Removing speakers .....	69	6.7.3.2 _CALIBRATING THE CROSSOVERS .....	101
6.3.8 _Configure the settings of each Speaker .....	70	6.7.4 _NO CALIBRATION .....	104
6.3.9 _Configure the crossover settings (optional) .....	71	6.8 _CALIBRATION .....	104
6.3.10 _Mapping the channels of different formats .....	71	6.8.1 _SINGLE-POINT CALIBRATION .....	105
6.3.11 _Sending pink noise to verify the routing of the speakers .....	72	6.8.2 _MULTI-POINT CALIBRATION .....	105
6.3.12 _Add a Parametric Equalizer .....	73	6.8.3 _COMMON PROBLEMS DURING CALIBRATION .....	108
6.3.12.1 _Add a PEQ .....	75	6.8.4 _WEIGHTING .....	109
6.3.12.2 _Delete a PEQ .....	75		
6.3.12.3 _Save a new PEQ group .....	76		

6.9 _COMPUTE .....	110
6.10 _ANALYZING THE RESULTS .....	111
6.10.1 _IMPORTANT NOTES.....	112
6.10.2 _GRAPHS DISPLAY OPTIONS .....	112
6.10.3 _CHOOSE DISPLAY OPTIONS ACCORDING TO YOUR RE- QUIREMENTS .....	113
6.11 _CHECKING THE SPEAKER POSITIONS AFTER CALIBRATION .. 114	

## 7 \_GOING FURTHER 117

7.1 _ESSENTIAL TOOLS AND SETTINGS .....	117
7.1.1 _METERING THE INPUTS AND OUTPUTS .....	117
7.1.2 _PLAYING PINK NOISE ON THE SPEAKERS .....	118
7.1.3 _SOLO/MUTE AN INPUT OR AN OUTPUT .....	119
7.1.4 _INPUT AND OUTPUT VOLUME .....	120
7.1.4.1 _INPUT VOLUME .....	120
7.1.4.2 _OUTPUT VOLUME.....	120
7.1.5 _EQUALIZATION.....	121
7.1.5.1 _FIR EQ .....	121
7.1.5.2 _31 BAND GRAPHIC EQS .....	122
7.1.6 _OUTPUT DELAY .....	124
7.1.7 _SWITCHING OPTIMIZATION ON/OFF.....	125
7.1.8 _MASTER CONFIGURATION.....	126
7.1.9 _AUDIO CLOCK SETTINGS .....	128
7.1.9.1 _AUDIO CLOCK STATUS INFORMATION .....	128
7.1.9.2 _AUDIO CLOCK SETUP .....	129
7.3 _TARGET CURVE.....	131
7.3.1 _OVERVIEW OF THIS PROCEDURE .....	131
7.3.2 _SETTING UP ONE OR MORE TARGET CURVES .....	132
7.4 _LIMITER CURVE.....	132
7.5 _ADVANCED OPTIMIZATION SETTINGS.....	133
7.5.1 _DISPLAY .....	134
7.5.2 _FRONT & SURROUND SPEAKER SETTINGS.....	134
7.5.3 _ACOUSTICS CORRECTION .....	134
7.5.4 _CALIBRATION SETTINGS.....	134
7.5.5 _OPTIMIZE ACCORDING TO L&R SPEAKERS SETTINGS .....	134
7.5.6 _FIR AND IIR SETTINGS.....	135
7.5.7 _LEVEL ALIGNMENT SETTINGS .....	135
7.5.8 _SUBWOOFER LOW-PASS FILTER SETTINGS .....	135
7.5.9 _DECIMATION SETTINGS & ADVANCED FIR SETTINGS.....	135
7.5.10 _ADVANCED FIR SETTINGS .....	135

## 8 \_DECODER / UPMIXER SET- TINGS 136

8.1 _SUPPORTED DECODERS/UPMIXERS .....	136
8.2 _LISTENING FORMATS.....	137
KNOWN ISSUES.....	138
8.3 _USING THE FRONT PANEL.....	138
8.3.1 _LISTENING FORMAT SELECTION.....	138
8.3.2 _DECODERS CONFIGURATION .....	139
8.4.1 _LISTENING FORMAT SELECTION.....	139
8.4.2 _DECODER CONFIGURATION.....	139
8.5 _DECODERS SETTINGS.....	140
8.5.1 _GENERAL SETTINGS.....	140
8.5.2 _DOLBY DECODER SETTINGS .....	141
8.5.3 _DTS DECODER SETTINGS.....	142
8.5.4 _AURO-3D DECODER SETTINGS.....	143

## 9 \_HDMI FEATURES 146

9.1 _HOW TO ACCESS THE HDMI MENU .....	146
9.2.1 _Troubleshooting an HDMI issue.....	149
9.2.1.1_ Video Inputs .....	149
9.2.1.2_ Video OUtputs.....	150
9.3 _SETUP TAB .....	151
9.4 _IN EDID TAB .....	152
9.5 _OUT EDID TAB.....	153
9.5.1 _Audio .....	153
9.5.2 _Video .....	153
9.5.3 _Refresh button.....	153

## 10 \_MANUAL CALIBRATION 154

10.1 _VERY IMPORTANT TIPS.....	154
10.2 _CHECKLIST BEFORE YOU START .....	154
10.3 _IMPORTANT RECOMMENDATIONS FOR MICROPHONE PLACEMENT .....	154
10.4 _CALIBRATE THE ACTIVE CROSSOVERS (OPTIONAL) 155	
10.4.1 _OVERVIEW OF THE CROSSOVER SETUP PROCEDURE ....	155
10.4.2 _CONFIGURE THE ADVANCED SETTINGS (OPTIONAL) .....	155
10.4.3 _ADJUST THE MASTER OUTPUT LEVEL .....	158
10.4.4 _CALIBRATE THE ACTIVE CROSSOVERS .....	159
10.4.5 _VERIFY THE SOUND OF THE CALIBRATED CROSSOVERS .... 160	
10.4.5.1 _VISUALIZE THE ACOUSTICAL GRAPHS FOR EACH SPEAKER .....	160
10.4.5.2 _LISTEN TO EACH SPEAKER CONNECTED TO THE CROSSOVER.....	161

10.4.6 _SAVE THE PRESET .....	161	13.6 _3D MEASUREMENT MICROPHONE.....	169
10.5 _CALIBRATE THE SPEAKERS IN THE ROOM.....	161	13.6.1 _MICROPHONE SPECIFICATIONS.....	170
10.5.1 _OVERVIEW OF THE CALIBRATION PROCEDURE.....	161	13.6.2 _POWER SUPPLY .....	170
10.5.2 _ADJUST THE MASTER OUTPUT LEVEL.....	161	13.6.3 _INDIVIDUAL COMPENSATION FILE .....	171
10.5.3 _NORMAL CALIBRATION SEQUENCE.....	162	13.6.4 _CONNECTION ORDER.....	171
10.5.4 _COMMON PROBLEMS DURING CALIBRATION.....	163	The individual compensation file of the microphone used by the Altitude <sup>32</sup> can be modified in the Optimizer Settings/Calibration page.171	
10.5.5 _CALIBRATION STATUS.....	163		
10.5.6 _CHECKING THE SPEAKER POSITIONS DURING/AFTER CALI- BRATION.....	163		
10.5.7 _MULTI-POINT MEASUREMENTS (OPTIONAL) .....	163		
10.5.8 _COMPUTE THE OPTIMIZATION FILTERS .....	164		
10.5.9 _SAVE THE PRESET .....	164		
11 _VERIFY THE SOUND OF YOUR OPTIMIZED SYSTEM	165		
11.1 _VISUALIZE THE GRAPHICS.....	165		
11.2 _LISTEN TO THE SYSTEM.....	165		
11.3 _SPEAKER SET WINDOW.....	165		
11.4 _BASS MANAGEMENT WINDOW.....	165		
11.5 _SAVE PRESET.....	165		
12 _IN CASE OF EMERGENCY, BREAK THE GLASS	166		
12.1 _WHAT YOU WILL NEED .....	166		
12.2 _TRINNOV AUDIO POLICY OF SUPPORT .....	166		
12.2.1 _CONTACT YOUR DEALER.....	166		
12.2.2 _SEND US AN EMAIL .....	167		
12.2.3 _CALL US.....	167		
13 _APPENDIX	168		
13.1 _INSERT AN EXTERNAL STEREO DAC .....	168		
13.2 _REMOTE START AND STOP .....	168		
13.3 _AUTOMATION.....	168		
13.4 _SIGNAL FLOW OF THE ALTITUDE <sup>32</sup> .....	169		
13.4.1 _SIGNAL FLOW OF THE Altitude <sup>32</sup> .....	169		
13.4.2 _SETUP PROCESS AND FILTERS CALCULATION.....	169		
13.5 _3D SPEAKER PLACEMENT RECOMMENDATIONS.....	169		

# NOTICES

## ACKNOWLEDGMENT

*DTS<sup>®</sup> is a registered trademark of DTS, Inc.*

*Dolby<sup>®</sup> is a registered trademark of Dolby Laboratories.*

*Auro-3D<sup>®</sup> is a registered trademark of Auro Technologies.*

*All other trademarks are the properties of their respective owners.*

*The Altitude<sup>32</sup> is manufactured under license from Dolby Laboratories. Dolby, Dolby Atmos, Dolby Surround, and the double-D symbol are trademarks of Dolby Laboratories.*

*For DTS patents, see <http://patents.dts.com>. Manufactured under license from DTS Licensing Limited. DTS, the Symbol, DTS in combination with the Symbol, DTS:X, and the DTS:X logo are registered trademarks or trademarks of DTS, Inc. in the United States and/or other countries. © DTS, Inc. All Rights Reserved.*

*The Altitude<sup>32</sup> is manufactured under license from Auro Technologies. Trinnov Audio is certified by Auro Technologies to implement its technology and products. Auro-3D<sup>®</sup> and the related symbols are registered trademarks of Auro Technologies. All materials contained in this work are protected by copyright law and may not be reproduced, distributed, transmitted, displayed, published or broadcast without the prior written permission of Auro Technologies NV or in case of third party materials, the owner of that content. You may not alter or remove any trademark, copyright or other notice from copies of the content.*

*©2003-2019 Trinnov Audio. All rights reserved.*

*Due to constant improvement, all products specifications and design may change without notice.*

*Photos and illustrations are non-contractual.*



# IMPORTANT SAFETY INSTRUCTIONS

To ensure optimal performance, please pay attention to the instructions in this Quick Start Guide:

Read these instructions. Keep these instructions. Follow all instructions.

Install the Altitude32 on a solid, flat, level surface that is dry, well ventilated and out of direct sunlight. Be sure that all four feet are supported.

Do not use this apparatus near water.

Clean only with a dry cloth. Do not use liquid solvent-based cleaners.

Protect the detachable power chord from being walked on or pinched particularly at plugs, convenience receptacles, and the point where they exit from the apparatus. If the ac cord becomes damaged, do not use it. Immediately replace it with a new one of the same or better rating.

Unplug this apparatus during lightning storms or when unused for long periods of time.

Do not open the equipment case or remove any of the cover panels. There is no serviceable part for this product. Refer all servicing to qualified service personnel.

To prevent fire or shock hazard, do not allow liquids to spill or objects to fall into any openings of the product.

Use only attachments/accessories specified by the manufacturer.

Do not defeat the safety purpose of the polarized or grounding-type plug. A polarized plug has two blades with one wider than the other. A grounding-type plug has two blades and a third grounding prong. The wide blade or the third prong is provided for your safety. If the provided plug does not fit into your outlet, consult an electrician for replacement of the obsolete outlet.

Before connecting the equipment, check that the main power supply voltage rating corresponds with the local main power supply. The rating of the main power supply voltage is printed on the equipment.

If replacement of the ac line fuse and/or any internal fuse becomes necessary, replace only with same value and type of fuse: 2xT1A 5x20mm. Never bypass the fuse.

It is imperative that the Altitude32 be operated in a well ventilated environment and the immediate external temperature be maintained as specified. Do not expose the Altitude32 to humidity, steam, smoke or excessive dampness or dust. Maximum permissible operating conditions: 0°C to 40°C, 20-65% relative humidity. External cooling fans may be required in some cases.

Do not stack any equipment directly above or below the Altitude32 as to

protect it from overheating, as well as the continued functionality of any equipment near and around it.

Remote control battery use trademark GP Batteries International, Panasonic or Varta, reference Renata CR2032 or trademark Duracell reference DL2032.

\*CAUTION: Risk of explosion if battery is replaced by an incorrect type. Dispose of used batteries according to the instructions, including list of batteries allowed.

Do not ingest the remote control battery. The remote control supplied with this product contains a coin battery. If the coin / button cell battery is swallowed, it can cause severe internal burns in just 2 hours and can lead to death. Keep new and used batteries away from children. If the battery compartment does not close securely, stop using the product and keep it away from children. If you think batteries might have been swallowed or placed inside any part of the body, seek immediate medical attention.

To completely disconnect the apparatus from the AC, completely remove the power cable from the main outlet.

Refer all servicing to qualified service personnel. Servicing is required when the apparatus has been damaged in any way, such as when the power-supply cord or plug is damaged, liquid has been spilled or object have fallen into the apparatus, or the apparatus has been exposed to rain or moisture, does not operate normally or has been dropped.



Do not expose this apparatus to dripping or splashing and ensure that no objects filled with liquids, such as vases, are placed on the apparatus.

The main plug of the power supply cord shall remain readily operable.

Do not expose batteries to excessive heat such as sunshine, fire or the like.

When using the product in 19 inches rack, mount the two brackets supplied with the product. Fit each of the two brackets with the supplied 3x M3x6mm countersunk steel (color black) countersunk screws under the chassis. Warning: these brackets are not suitable for wall mount.

**TO COMPLETELY DISCONNECT THIS APPARATUS FROM THE AC MAINS, DISCONNECT THE POWER SUPPLY CORD PLUG FROM THE AC RECEPTACLE.**

CAUTION	
<b>RISK OF ELECTRIC SHOCK. DO NOT OPEN</b>	
	THE LIGHTNING FLASH WITH AN ARROWHEAD SYMBOL WITHIN AN EQUILATERAL TRIANGLE IS INTENDED TO ALERT THE USER TO THE PRESENCE OF UNINSULATED «DANGEROUS VOLTAGE» WITHIN THE PRODUCT'S ENCLOSURE THAT MAY BE OF SUFFICIENT MAGNITUDE TO CONSTITUTE A RISK OF ELECTRIC SHOCK TO PERSONS.
	THE EXCLAMATION POINT WITHIN AN EQUILATERAL TRIANGLE IS INTENDED TO ALERT THE USER TO THE PRESENCE OF IMPORTANT OPERATING AND MAINTENANCE (SERVICING) INSTRUCTIONS IN THE LITERATURE ACCOMPANYING THE PRODUCT.
<b>WARNING:</b> TO REDUCE THE RISK OF FIRE OR ELECTRIC SHOCK, DO NOT EXPOSE THIS APPARATUS TO RAIN OR MOISTURE.	

# INTRODUCTION

*Trinnov Audio derives from "Tri-innovation", hence Innovation in 3D Audio. Our company's constant focus in this field of research has allowed us to develop the most advanced, innovative, powerful and scalable 3D AV Preamplifier ever manufactured.*

*Thanks to a unique hardware platform, Trinnov Audio offers the first implementations of the latest home theater audio technologies. The Altitude32 has established a new leadership position within the luxury home cinema processors category, opening the way for a whole new generation of modern, scalable and software oriented home cinema processors.*



## 1.1 \_ABOUT THIS GUIDE

This guide includes the most important information you need in order to use and setup the Altitude<sup>32</sup> in your home theater system. From the most frequent daily operations to advanced calibration and optimization functionality, this document will guide you through every step of the task you wish to accomplish.

This guide is organized in the following parts:

### PART I: GETTING STARTED WITH THE ALTITUDE<sup>32</sup>:

---

- **Introduction:** unpacking the Altitude<sup>32</sup> as well as an overview of the hardware and the software.
- **Network Setup:** setting up a network to start using the software.

### PART II: USING THE ALTITUDE<sup>32</sup> ON A DAILY BASIS IN YOUR HOME THEATER:

---

- **Daily Operations:** Explains how to perform simple operations such as power-on/power-off, volume control, source selection, preset selection and decoder settings via the front panel, with the IR remote control or through the software user interface.
- **Basic Settings:** Explains how to name and configure your sources, how to switch on/off main optimization and remapping options, how to manage presets and how to backup/restore presets to/from a USB memory stick.

### PART III: INTEGRATING THE ALTITUDE<sup>32</sup> IN YOUR HOME THEATER SYSTEM:

---

**Overview of the setup procedure:** A summary of the main steps you must follow in order to integrate the Altitude<sup>32</sup> successfully.

**Essential tools and settings:** Provides important information about the software tools and settings you need to know before starting the setup process.

**Specify the Speaker Layout:** How to provide the Altitude<sup>32</sup> with all the information about your set of speakers. This information is required for the automatic calibration of the speakers in the room.

**Specify an Array of Speakers:** Provides information to setup an array of speakers.

**Decoder/Upmixer Settings:** Provides necessary information on the different decoders supported, their upmixer and the settings available.

**Getting ready for calibration:** Provides important tips and recommendations you need to know before running the calibration procedure, including tips about microphone placement.

**Optional:** Calibrate the Active Crossovers: Explains the setup procedure for multi-amplified speakers using the Altitude<sup>32</sup>'s intelligent crossover calibration tool.

**Calibrate the Speakers in the Room:** Explains the calibration process for the speaker system and how to compute the optimization filters.

**Setup Bass Management:** Explains the advanced bass management options supported by the Altitude<sup>32</sup>.

**Setup the Target Curves:** Explains how to use the powerful target curve functionality of the Altitude<sup>32</sup> to reach your required frequency response.

**Verify the Sound of your Optimized System:** A short chapter to remind you that it is crucially important to verify the sound of your system after each calibration.

## PART IV: TUNING THE SOUND OF YOUR HOME THEATER SYSTEM WITH THE ALTITUDE<sup>32</sup>:

**Tuning the Optimization Settings:** Explains how to use the advanced settings of the Altitude<sup>32</sup> to make further improvements to the automatic optimization.

**Performing Multi-point Measurements:** How to improve the optimization by performing multiple measurements with different microphone placements.

### ADDITIONAL INFORMATION ABOUT THE ALTITUDE<sup>32</sup> PREAMPLIFIER:

**Appendix:** Technical information about automation, the signal flow, the 3D speaker placement recommendations, connector pinouts and the 3D Measurement Microphone.

To improve clarity throughout this document, references to user interface items will be shown in **bold** letters and illustration captions will be shown in *italic* letters.

This guide also includes information about the latest 3D formats and common practice in terms of speaker placement to help you understand the new approach of 3D Sound in the best possible and least confusing way.

In addition, important information will be indicated with the following symbols.



### RECORD OF CHANGES:

DATE	SOFTWARE VERSION
August, 2019	V4.2: Software version 4.2.11



NOTE: the design and the user experience of the Altitude<sup>32</sup>'s Graphic User Interface are constantly improved with software updates.

## 1.2\_PRODUCT INFORMATION

### MAIN FEATURES

- 32 Channel Digital Audio Processor
- Universal Spatially-Accurate 3D Audio playback
- Fully integrated, best-in-class Speaker/Room Optimization
- Superior multi-subwoofer management and active crossovers calibration
- 7x HDMI Inputs, 2x HDMI Outputs
- DCI Input
- User-friendly, self-explaining user interface
- Built-in Wi-Fi & UPnP/DLNA Compliant Digital Media Renderer
- Wide choice of Remote Options
- Available as an 8, 16, 24 and 32 channel processor
- Upgradable from 8 to 16, 24 and 32 channel processor
- Room end-point

### EXCLUSIVE TECHNOLOGIES

- 192 kHz native processing up to 24 channels
- Trinnov patented 2D/3D spatial remapping
- Trinnov Loudspeaker/Room Optimization
- Mac Trinnov Application for control
- Next Generation Hardware platform:
  - Revolutionary architecture, scalable processing platform
  - Software-oriented upgrades provided over the internet, no DSP upgrade required
- Robust design, inspired by our professional audio product lines
- Trinnov high-performance AD/DA converters, used daily by the most demanding mastering studios
- VNC Remote Control through the network from any smartphone, tablet or laptop
- Web-based responsive interface
- Automation via IP and RS232 protocols
- Crestron and Savant modules available
- Built-in Gigabit Ethernet and Wi-Fi
- IR remote control included
- 12V Trigger in/out / Within the interface

### SUPPORTED AUDIO/VIDEO FORMATS

- 3D Audio Codecs: Auro-3D, Dolby Atmos and DTS:X, including their respective upmixers
- HD Audio Codecs: Dolby TrueHD, DTS-HD Master Audio
- HDMI 2.0, HDCP 2.2- compliant digital audio with 4K and 3D video pass-through
- HDR support, Dolby Vision Compatible
- Room: FLAC, WAV, MQA, DSF, DFF, AIFF, ALAC, AAC, MQA; 2.0, 5.1 and 7.1 multichannel audio
- UPnP/DLNA renderer: WAV, AIFF, OGG, FLAC up to 24 bits / 96 kHz

### SUBWOOFER MANAGEMENT

- Adjustable High-pass / Low-pass editable by individual satellite/sub or by group of speakers
- Unlimited subwoofers (limited by number of available outputs)
- Automatic level, delay and phase alignment
- Unprecedented flexibility
- Exclusive intermediate bass management

### AUDIO PROCESSING

- Comprehensive Processing latency control
- Automatic Processing:
  - Multi-point acoustic measurement (Trinnov 3D measurement microphone)
  - Time/Frequency acoustic analysis based on impulse response measurement
  - Loudspeaker/Room optimization
  - Exclusive semi-automatic Active Crossovers alignments for up to 4-way active speakers below "Loudspeaker/Room Optimization"
- Manual Processing: Several layers of 31 bands Graphic EQ, FIR EQ, Parametric EQ, gains, polarity and delays available for every channel.
- Total delay given in meters / milliseconds / frames for the listening point and adjustable global delay for accurate Lip Sync

### PHYSICAL CHARACTERISTICS

- Chassis: 3.5U
- Power supply: 240V AC / 50-60 Hz
- Consumption: 100W max.
- Fuse: 110VAC operation: FST 5x20mm 800mA, 230VAC operation: FST 5x20mm 1A 230 VAC operation: 2xT800mA 5x20mm
- Weight: ~11.3 kg / 24.9 lbs
- Environmental conditions - Operating: 0°C-40°C (32°F-104°F) / Humidity: 20%-80% relative humidity (without condensation)

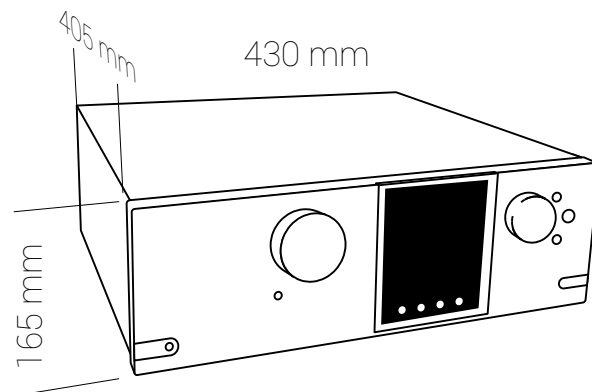

## 1.3 \_SYSTEM INTEGRATION

The Altitude<sup>32</sup> is inserted before the amplifier and loudspeakers to correct imperfections of the room and the loudspeakers. During calibration, the speakers are calibrated with a 3D acoustic probe.

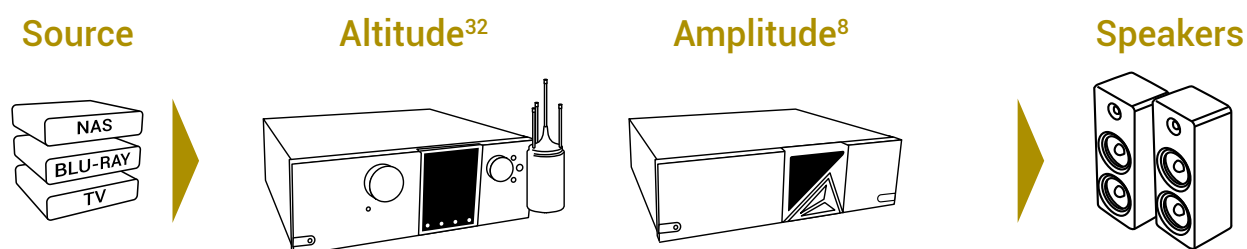

*Figure 1: Altitude<sup>32</sup> system integration*

## 1.4 \_TRINNOV CERTIFIED INSTALLERS

Depending on how far you want to dig into its features, the Optimizer is either a straightforward and easy-to-use automatic compensation system or an incredibly flexible and powerful tool, including numerous advanced filter parameters, target curves and manual EQs, all being re-computable on the fly.

By following an iterative installation procedure, the Optimizer achieves results beyond expectations in record time. Nevertheless, It surely requires a good understanding of audio and acoustic basics. Especially, experience to clearly identify a problem and therefore use a relevant method to solve it.

We strongly recommend you request the services of a Certified Trinnov Installer to setup and fine tune your Altitude<sup>32</sup> in your home theater system.

## 1.5 \_UNPACKING THE ALTITUDE<sup>32</sup>

■ You will find in the Altitude<sup>32</sup> packaging:



*The Trinnov Altitude<sup>32</sup> AV preamplifier*



*3D Microphone  
(Optional)*



*WiFi antenna*



*Power  
Chord*



*CR2032  
Battery*



*Remote control*



*Rack ears*



## 1.6 \_THE HARDWARE

### 1.6.1 \_FRONT PANEL LAYOUT



### 1.6.2 \_FRONT PANEL DISPLAY



NOTE: After 30 seconds of inactivity, the screen saver makes the front panel fades and letters become less visible.

### 1.6.3\_REAR PANEL LAYOUT

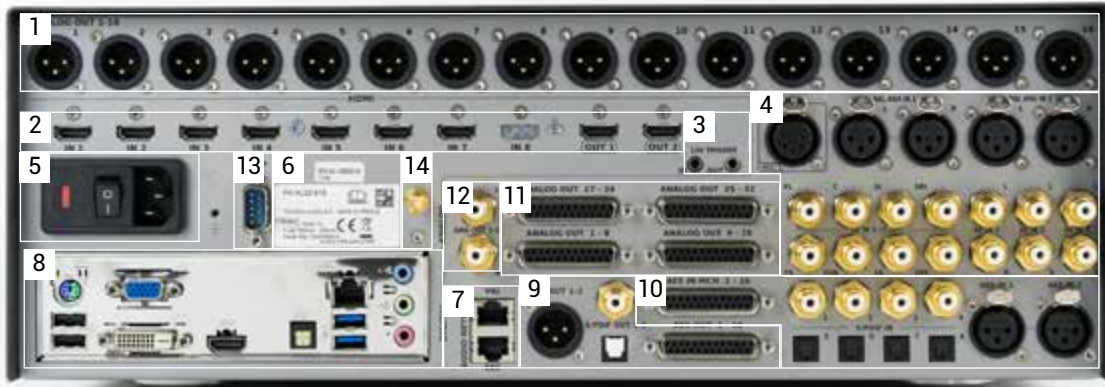

1	XLR ANALOG OUTPUTS 1-16	8	PC CONNECTORS may change following the mother board reference
2	7 Inputs HDMI, 2 Outputs HDMI <ul style="list-style-type: none"> <li>•Input #1-7 can be switched between HDMI 2.0 and HDMI 1.4 compatibility modes, see chapter 9.3</li> <li>•Output #1 is HDMI 1.4 . HDCP 1.4</li> <li>•Output #2 is HDMI 2.0 / HDCP 2.2</li> </ul>	9	DIGITAL OUTPUTS <ul style="list-style-type: none"> <li>•2x S/PDIF Output (1x optical and 1x coaxial)</li> <li>•1x AES Output</li> <li>•16 channels Output (DB 25)</li> </ul>
3	TRIGGER 12V IN/OUT <ul style="list-style-type: none"> <li>•1x Input trigger</li> <li>•1x Output trigger</li> </ul>	10	DIGITAL INPUTS <ul style="list-style-type: none"> <li>•8x Inputs on S/PDIF (4 optical and 4 coaxial)</li> <li>•2x Input on AES</li> <li>•1x DCI AES Input on DB 25</li> </ul>
4	ANALOG INPUTS <ul style="list-style-type: none"> <li>•2x XLR Stereo Inputs balanced</li> <li>•3x RCA Stereo Input</li> <li>•1x 3D Microphone Input on 5-pin XLR</li> <li>•1x RCA 7.1 input</li> </ul>	11	•4x 8 Channels Outputs balanced on DB 25
5	POWER <ul style="list-style-type: none"> <li>•AC Input</li> <li>•Fuse</li> <li>•Master Power Switch</li> </ul>	12	•1x RCA Stereo Output
6	SERIAL NUMBER	13	•RS-232 Automation
7	AUDIO NETWORK <ul style="list-style-type: none"> <li>•Dual network audio connector (for future use)</li> </ul>	14	•WiFi antenna connector



## 1.6.4\_IR REMOTE CONTROL

### 1 TO 4

•Direct source selection

### MENU

•Access to Listening format / Optimizer / Setup / Preset / About

### VOL +/-

•Volume control (1dB step)



### SOURCE

•Source selection

### FORMAT

•Listening format selection

### OPTIMIZER PRESETS

•Preset selection

### LIGHT

•Switches off the backlight on the front panel

### DIM

•Decreases the volume by 20dB (toggle button)

### MUTE

•Mutes audio outputs (toggle button)

### BYPASS

•Optimizer bypass

## 1.7 \_THE SOFTWARE

### 1.7.1 \_AVAILABLE OPTIONS TO ACCESS THE GRAPHICAL USER INTERFACE

The Altitude<sup>32</sup> offers multiple options to display and control the user interface:

- **Directly** with a physical display, a mouse and a keyboard connected to the Altitude<sup>32</sup>.
- **Remotely** with a **VNC Client** over the network, from any computer or tablet to access the full user interface in order to operate and/or setup the Altitude<sup>32</sup>.
- **Remotely** with an **internet browser**, with limited access to the user interface allowing to operate the Altitude<sup>32</sup> but without all the setup menus.

Mac Trinnov app available in the Support/Download section of our website ([www.trinnov.com/support/](http://www.trinnov.com/support/))

The Graphical User Interface of the Altitude<sup>32</sup> is specifically designed for touch screen use but it is just as easy to use with your laptop's trackpad or with a mouse.

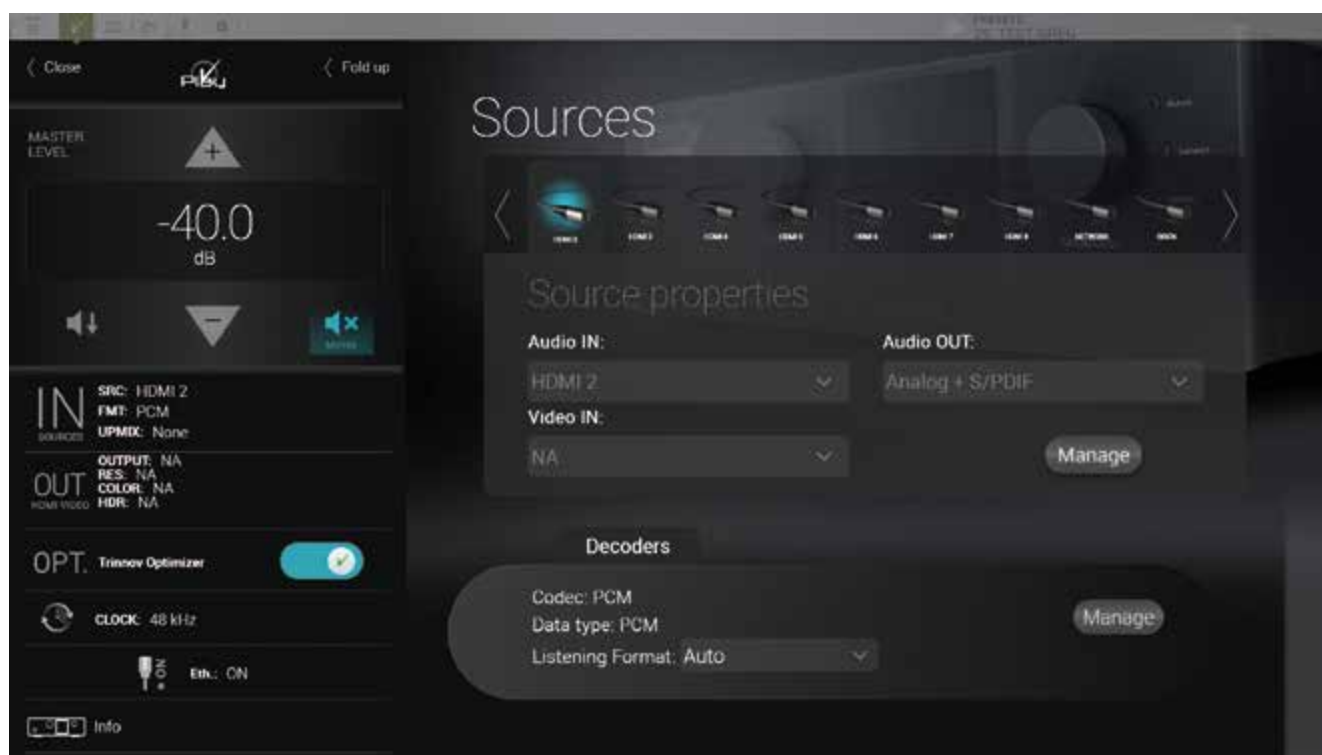

Figure 2: The graphical user interface of the Altitude<sup>32</sup>



NOTE: the design and the user experience of the Altitude<sup>32</sup>'s Graphic User Interface are constantly improved with software updates.

### 1.7.2 \_IMPORTANT NOTE ABOUT THE WEB-BASED INTERFACE

The Altitude<sup>32</sup>'s full user interface can only be accessed by connecting a display or through a VNC client.

If you've already completed the setup of the Altitude<sup>32</sup> in your home theater system and you only need to operate it, a limited part of the Altitude<sup>32</sup>'s user interface is also available from a *web browser*.



NOTE: The web browser can only display the HTML-based pages of the user interface. However, most of the system setup pages of the Altitude<sup>32</sup> are currently Linux-based. Therefore, the web browser can only be used for daily operations of the Altitude<sup>32</sup> but cannot be used to setup, measure and optimize your speaker system.

To connect to the web user interface of the Altitude<sup>32</sup>s you need to enter its IP address in your web browser.

The IP address of the Altitude<sup>32</sup> can be retrieved:

- via the front panel: go to the Setup/Network/Ethernet menu.
- by connecting a monitor and a mouse to the back panel. Go to the Network page of the graphical user interface.
- If you are already connected to the Altitude<sup>32</sup> with a VNC Client, you can easily check its IP address:
  - in Mocha VNC: click on the blue arrow, located at the right of the VNC Server address field;
- Please refer to the Network Setup chapter for further details about network configuration.

### 1.7.3 \_USING A DISPLAY, MOUSE AND KEYBOARD CONNECTED TO THE ALTITUDE<sup>32</sup>

A very straightforward option to access and control the user interface of the Altitude<sup>32</sup>, provided that you have the necessary equipment, is to connect a physical display and use a mouse and a keyboard to control the Altitude<sup>32</sup>'s software.

These devices shall be connected to the PC connectors, located on the rear panel of the Altitude<sup>32</sup>:

- PC/Mouse can be connected either using the PS/2 or USB ports.
- A physical monitor can be connected through the VGA, DVI-D or HDMI ports. The PC video outputs may change following the motherboard reference :

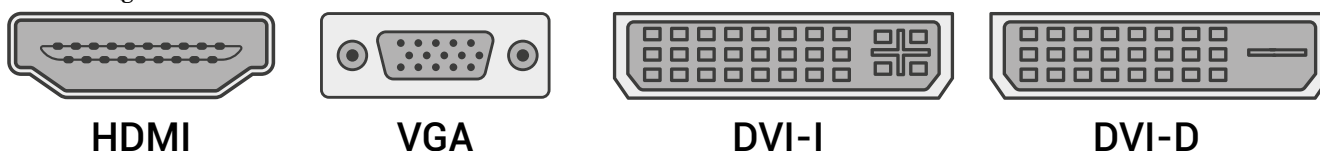

### 1.7.4 \_THE TOP MENU BAR

The Top Menu provides access to the main features of the Altitude<sup>32</sup>.



Opens the Advanced settings graphical user interface, used for configuring your sources, room calibration, advanced processor settings, network setup, etc... Most of its functionality is explained in the chapters Calibrate the Speakers in the Room and Tuning the Optimization Settings.



Opens the lateral Play menu used for daily operation: level adjustment, source selection and general information. See the chapter Daily Operations.



Opens the Speakers/Room setup tool, used for setting up your speaker system and for routing the channels to the speakers. See the chapter Specify the Speaker Layout.



Opens the Fine Tuning page, which includes the Bass Management and the Optimizer Settings. See the chapters Setup Bass Management and Tuning the Optimization Settings is a drop-down menu useful for quickly selecting a preset.



Opens the Setup Wizard which leads you through a simple setup and calibration.

## 1.7.5 \_THE MAIN USER INTERFACE

The main page of the Altitude<sup>32</sup> is used for daily operation:

1. Click on the Play button on the top left corner of the interface: the lateral menu unfolds,
2. Select one of the tabs to open the corresponding panel. For example, the Input Sources tab opens the Sources panel,
3. Perform a daily operation, such as selecting a different source.



*A detailed description of this interface is provided in the following pages.*

## 1.7.6 \_THE SIDE MENU BAR











You can access the Play menu, located on the left-hand side of the user interface, at any time by clicking on the "V" button on the Top menu.

This menu constantly provides information about the **current status** of the Altitude<sup>32</sup>. It can be **folded** or **unfolded** depending on the task you wish to perform.



## 1.7.7 \_FOLDED SIDE MENU

When folded, the side menu provides the following features:

	<ul style="list-style-type: none"> <li>• Click to unfold the lateral menu.</li> </ul>	<ul style="list-style-type: none"> <li>• Unfold button</li> </ul>
	<ul style="list-style-type: none"> <li>• Click to increase output level in 1dB steps.</li> </ul>	<ul style="list-style-type: none"> <li>• Volume Control</li> </ul>
	<ul style="list-style-type: none"> <li>• Displays the current output level.</li> </ul>	
	<ul style="list-style-type: none"> <li>• Click to decrease output level in 1dB steps.</li> </ul>	
	<ul style="list-style-type: none"> <li>• Mute: cuts all outputs.</li> </ul>	
	<ul style="list-style-type: none"> <li>• Dim: attenuates the output level (by default -20dB).</li> </ul>	
	<ul style="list-style-type: none"> <li>• Displays which audio source is currently selected as you move the cursor over the icon.</li> </ul>	<ul style="list-style-type: none"> <li>• Source Information</li> </ul>
	<ul style="list-style-type: none"> <li>• Displays the current status of the Optimizer.</li> </ul>	<ul style="list-style-type: none"> <li>• Optimizer Status</li> </ul>
	<ul style="list-style-type: none"> <li>• Click to enable/disable the Optimizer.</li> </ul>	<ul style="list-style-type: none"> <li>• Audio Clock</li> </ul>
	<ul style="list-style-type: none"> <li>• Displays the current status of the Wi-Fi and Ethernet network interfaces of the Altitude32.</li> </ul>	<ul style="list-style-type: none"> <li>• Network Status</li> </ul>

### 1.7.8\_UNFOLDED LATERAL MENU

When unfolded, the lateral menu displays extra information about the current settings of the Altitude<sup>32</sup>

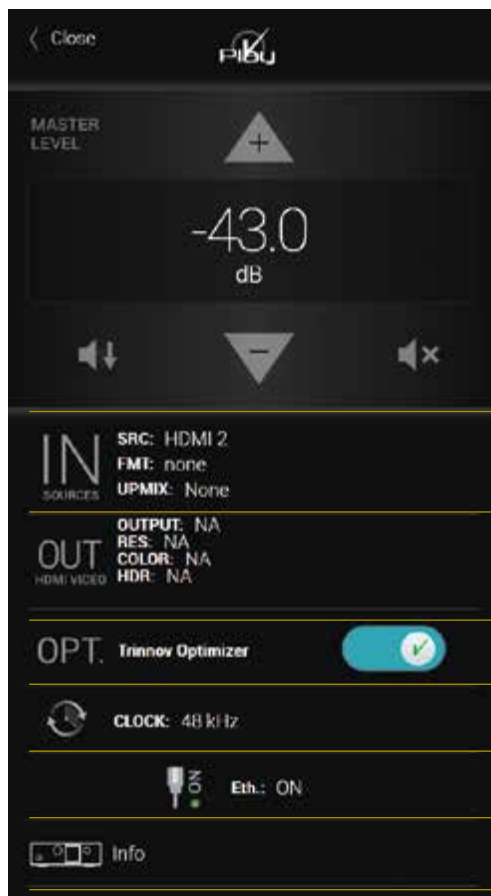

•IN sources	<ul style="list-style-type: none"> <li>•SRC: the name of the current audio source</li> <li>•FMT: the audio format</li> <li>•UPMIX: the upmix format</li> </ul>
•OUT sources	<ul style="list-style-type: none"> <li>•OUTPUT: the current HDMI output</li> <li>•RES: the current video resolution</li> <li>•COLOR: color settings used on the HDMI video output</li> <li>•HDR: show if HDR is activated</li> </ul>
•OPT displays the current status of the Optimizer.	
•CLOCK displays the current sampling rate	
•Wi-Fi and Ethernet network status	
•More information on your Altitude <sup>32</sup> .	





### 1.7.9 \_THE SPEAKERS/ROOM SETUP TOOL

The speakers/room setup tool is a highly practical tool used to setup your system. It is explained in the **Specify the Speaker Configuration** chapter.

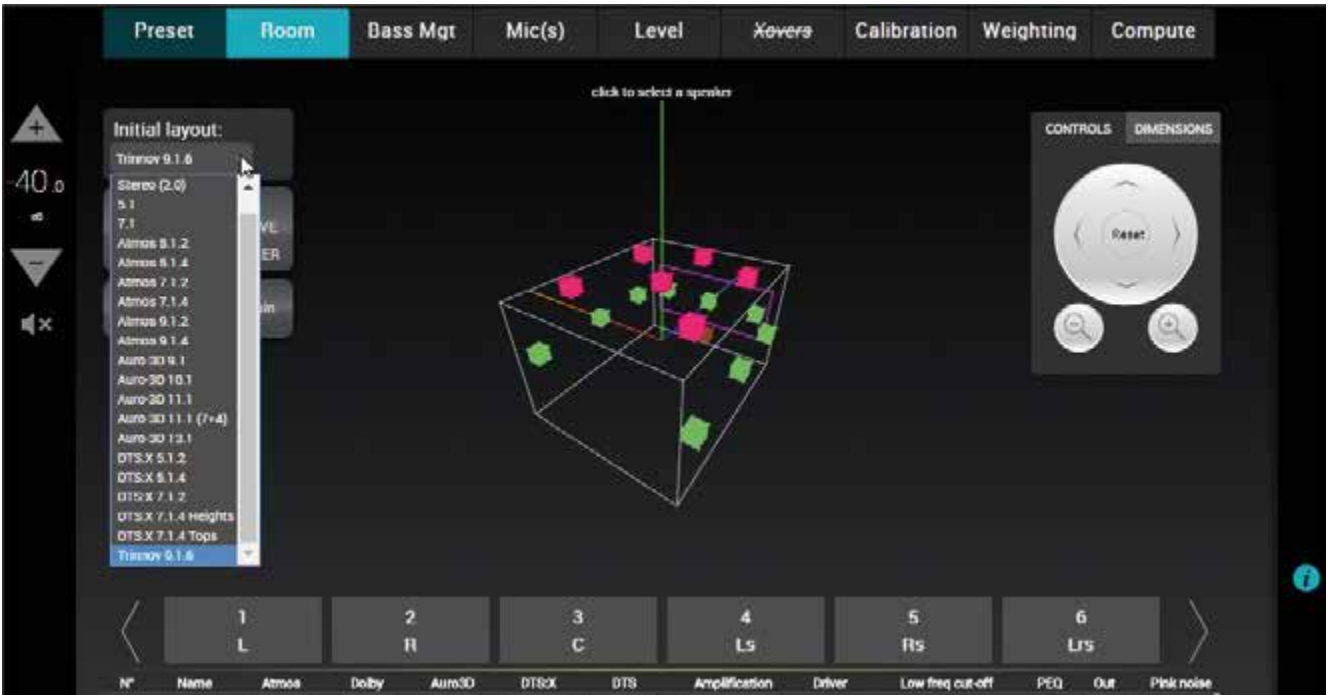
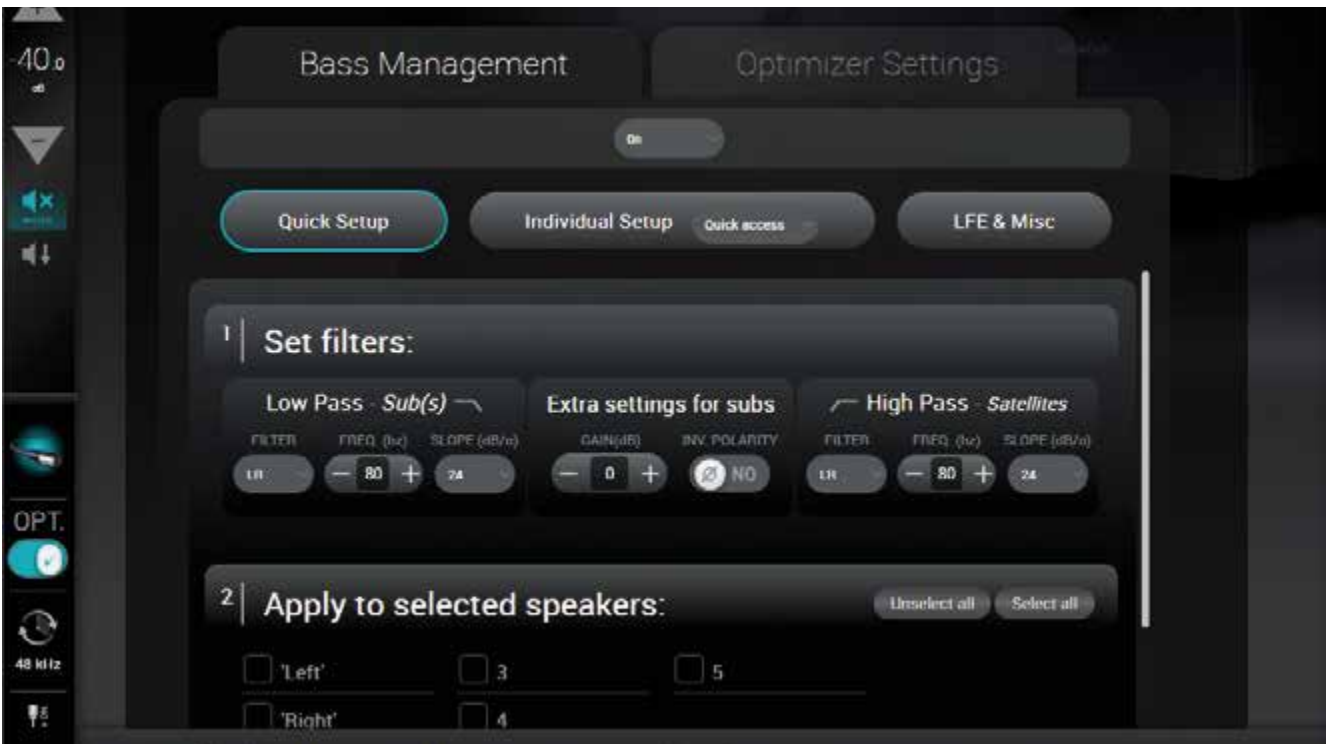

Figure 4: the Speakers/Room setup tool

### 1.7.10 \_THE FINE TUNING PANEL

The Fine Tuning panel gives access to the **Bass Management** and **Optimizer settings**:



### 1.7.11 \_THE ADVANCED SETTINGS INTERFACE

The Altitude<sup>32</sup> was designed to maintain its leadership over time and will therefore benefit from continuous updates as well as features. By default, the software update can only be performed by your local reseller or distributor. If an update is available, please ask your dealer to perform the update. You can also ask your dealer to unlock your Altitude<sup>32</sup> so that you can perform future updates on your own, from the user interface.

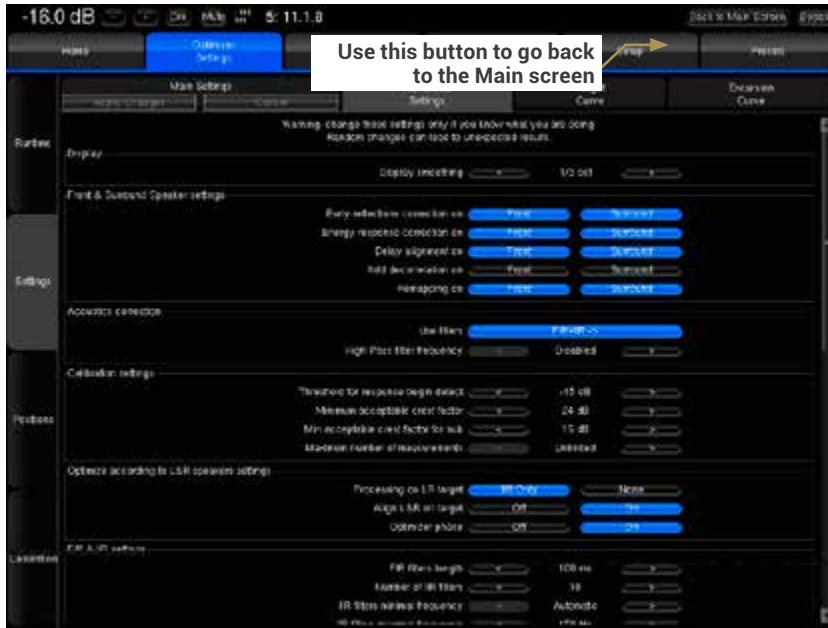

Figure 5: the advanced settings user interface of the Altitude<sup>32</sup>

For more information about the advanced settings, please refer to the *Tuning the Optimization Settings* chapter.

### 1.7.12 \_PRODUCT INFORMATION

Product Information can be displayed on the Graphical User Interface default startup

page and/or on the front-panel menu of the Altitude<sup>32</sup>.

- **Version:** software version currently installed
- **Build date:** software release build date
- **Product ID:** Trinnov unique id number of the unit
- **Serial:** serial number of the unit

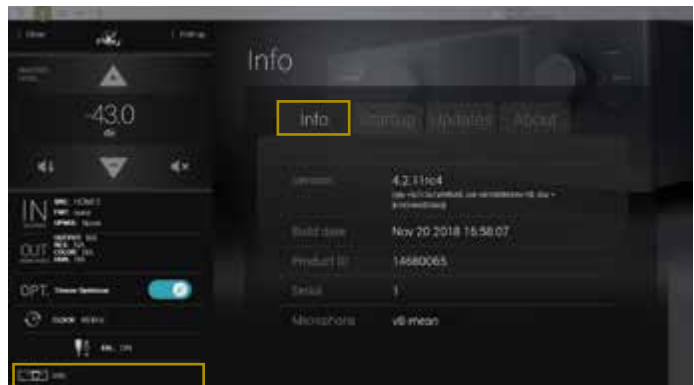

Figure 6: product information page

- **Microphone:** default microphone compensation file



Figure 7: The front-panel About page

To display the About page on the front panel, hit the **Menu** button on the front panel of the Altitude<sup>32</sup>. Select the last item **About** and hit the **Select** button.

### 1.7.13 \_SOFTWARE UPDATES

The Altitude<sup>32</sup> was designed to maintain its leadership over time and will therefore benefit from continuous updates as well as new features. If an update is available, please ask to your dealer to upgrade your Altitude<sup>32</sup>.

Software updates and support can be performed remotely by Trinnov provided that the Processor is connected to the internet and that outgoing connections to port 22 are open. The Trinnov technical operator will also need the serial number of your Altitude<sup>32</sup>.

When the processor is connected to Trinnov's server, the Network Status in the Setup/Network page will change to "Connected to Trinnov Audio Server".

If the processor is connected to a network, but the Network Status is "Local Network OK", it means that the Trinnov Server cannot be reached from your network.

Default preset: Set which preset will be loaded when the Altitude<sup>32</sup> is powered on.

Max. volume (dB): Set the maximum volume of the Altitude<sup>32</sup>.

Dim level (dB): Set the value of the Dim function.

Front Panel Light: You can turn off the lights of the front panel.

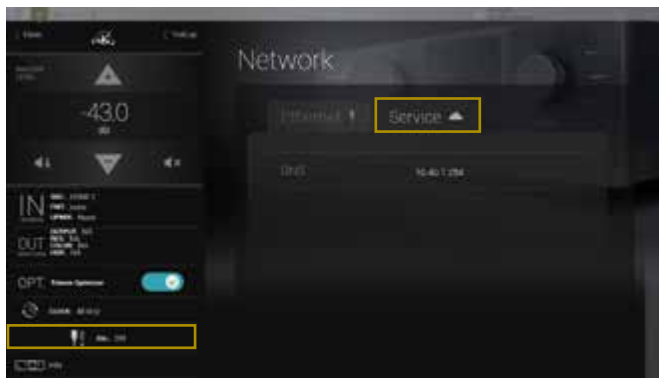

Figure 8: The Network/Service page

Use the **Info/Updates** page to check for new software updates:

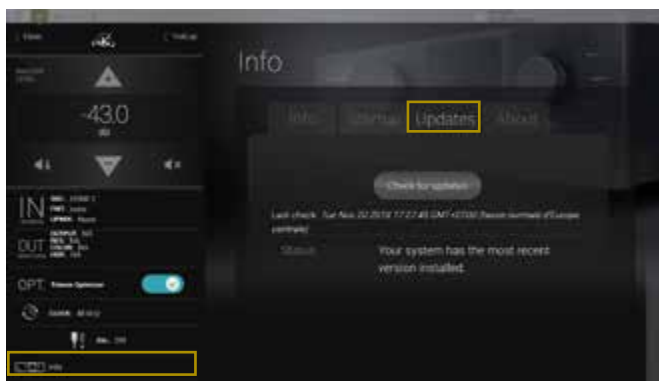

Figure 9: the Info/Updates page

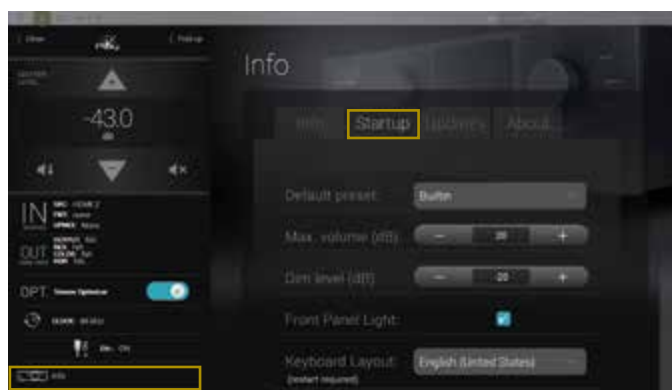

Figure 10: the Info/Startup page

# 2\_NETWORK SETUP

This chapter explains how to connect with your preferred device (tablet, laptop or desktop computer) to the Altitude<sup>32</sup> through a Wi-Fi or Ethernet network.

## 2.1 \_CONNECTING TO THE Altitude<sup>32</sup>

### \_2.1.1 \_OVERVIEW OF THE NETWORK CONNECTION PROCEDURE

The factory settings of the Altitude<sup>32</sup> are designed to make it as easy as possible to establish the first network connection between your device (tablet or computer) and the Altitude<sup>32</sup> so that you can access its graphic user interface.



IMPORTANT NOTE: Please keep in mind that another straightforward option for using the Altitude<sup>32</sup> software is to connect a display, mouse and keyboard directly to the back panel PC connectors.



1. Step 1: download and install a VNC Client software application on your device.
2. Step 2: put the Altitude<sup>32</sup> and your device on the same network. choose one of these options :
  - A. Your device joins the Altitude<sup>32</sup>'s Wi-Fi network: disconnect your device from your usual WiFi network and connect it to the Altitude<sup>32</sup>'s own Wi-Fi network (Access Point).
  - B. The Altitude<sup>32</sup> joins your existing Wi-Fi network: use the Altitude<sup>32</sup>'s front panel menus to connect it to your local Wi-Fi network
  - C. The Altitude<sup>32</sup> joins your existing Ethernet network : use an Ethernet cable to connect the Altitude<sup>32</sup>
3. Step 3: open your VNC Client and configure it in order to connect to the Altitude<sup>32</sup>'s VNC Server. Choose one of these options:
  - A. iOS devices, Android devices or Mac OS X computers: the zeroconf-enabled VNC client available for these devices will not require knowing the IP address of the Altitude<sup>32</sup>.
  - B. Windows computers: you will need to configure your VNC client (Tight VNC) with the IP address of the Altitude<sup>32</sup>.
3. Once your VNC Client is configured correctly, connect to the Altitude<sup>32</sup>'s VNC Server and start using the Altitude<sup>32</sup>'s graphical user interface.

These steps are described in detail in the following pages.

## 2.1.2 \_STEP 1: DOWNLOAD AND INSTALL A VNC CLIENT ON YOUR DEVICE

### \_2.1.2.1 \_USING A TABLET

If you are connecting from an iOS, Android or Windows tablet you will need to download and install a VNC Client app on your tablet. A number of VNC Clients/Viewers are currently available. We recommend the Mocha VNC Lite free app:

•iOS devices (Apple iPad): use the App Store app to download and install the Mocha VNC Lite app from Apple's App Store.	
•Android devices: use the Play Store app to download and install the Mocha VNC Lite app from Google's Play Store.	
•Windows mobile devices: use the Windows Store app to download and install the Mocha VNC Lite app from the Windows Store.	

### \_2.2.2.2 \_USING A MAC OS X COMPUTER

If you are connecting from a Mac OS X computer running OS X version 10.5 or higher, you can choose to use Apple's Screen Sharing VNC client integrated into the OS X operating system. In this case, you don't need to download an additional app and you can skip to the next step.

If your Mac is running OS X version 10.4 or lower, you need to install a VNC client software: download and install Chicken of the VNC from [www.macupdate.com](http://www.macupdate.com)



Figure 11: the Altitude<sup>32</sup>'s graphical user interface from a Mac OS X desktop

### \_2.2.2.3 \_USING A WINDOWS COMPUTER

If you are connecting from a Windows computer, you need to download and install a VNC Client software. A number of VNC Clients/Viewers are currently available.

We recommend Tight VNC: download and install Tight VNC from [www.tightvnc.com](http://www.tightvnc.com)

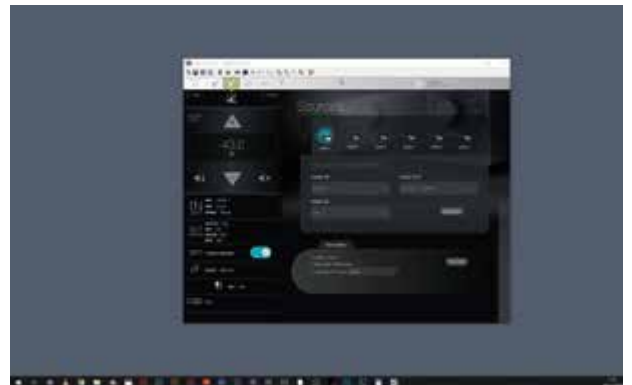



Figure 12: tthe Altitude<sup>32</sup>'s graphical user interface from a Windows desktop

 NOTE: Tight VNC is not zeroconf-enabled. You will need to enter the IP address of the Altitude32 in order to connect.

## 2.1.3 \_STEP 2: PUT THE ALTITUDE<sup>32</sup> AND YOUR DEVICE ON THE SAME NETWORK

The factory setting for the Altitude<sup>32</sup>'s Ethernet mode is set to DHCP. Therefore, the Altitude<sup>32</sup> will automatically be detected and configured on most local networks.

The benefit of this Ethernet-based option is that you don't need to switch your tautological device to another network. Therefore, if your network has Internet access, you will remain connected to the Internet while also being connected to the Altitude<sup>32</sup>.

To connect the Altitude<sup>32</sup> to your local Ethernet network:

Use an Ethernet cable to connect the Altitude<sup>32</sup> to your router or ISP Box;

Use the Altitude<sup>32</sup>'s front panel to check that it now has an IP address: go to the Setup/Network menu to see the network configuration.

Once the Altitude<sup>32</sup> is connected to your local network, you can move to the next step of the procedure: configure and connect your VNC client to the Altitude<sup>32</sup>'s VNC server.

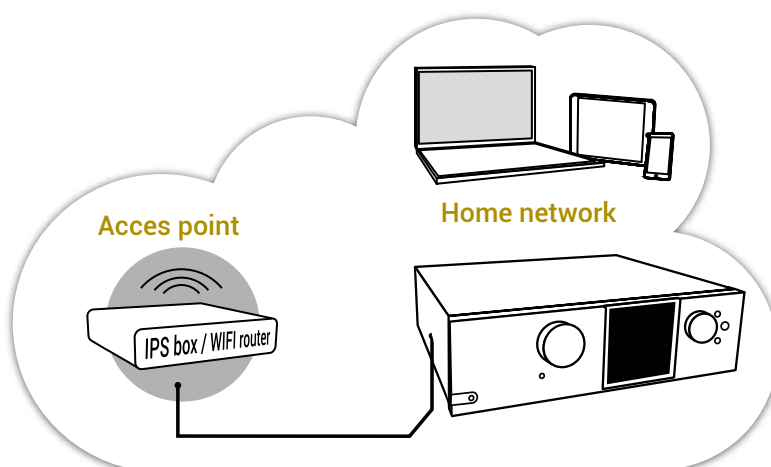

Figure 13: connecting the Altitude<sup>32</sup> to an ISP box or Wi-Fi router via Ethernet connection

The figure above shows that the Altitude<sup>32</sup> is hard-wired to the Internet Service Provider Box / Wi-Fi Router of the local home network.

If your local network has a Wi-Fi Access Point, you can then access the Altitude<sup>32</sup> from any wireless device connected to your local Wi-Fi Access Point.



### NOTE:

- This configuration only works if the router includes an active DHCP server.
- The standard settings of your ISP box should allow the Altitude<sup>32</sup> to reach the Trinnov Audio's Server for software updates through the internet.

## 2.1.4 \_STEP 3: CONNECT TO THE ALTITUDE<sup>32</sup> FROM YOUR DEVICE

### \_2.1.4.1 \_USING A TABLET WITH MOCHA VNC LITE

To connect to the Altitude<sup>32</sup>'s VNC Server from an iOS or an Android device, use the Mocha VNC Lite application:

- Open the Mocha VNC Lite app in your iOS or Android device. Click on the Configure menu item located in the top left of the page.
- In the Configure page, click on the line "New... Add a configuration".



Figure 14: adding a new VNC Server configuration

In the list of VNC Server parameters, click on the "i" button located in the top right of the page, next to the VNC server address.



Figure 15: configuring the VNC Server

In the list *Find local workstations*, select the line named "#VNC Server on Altitude<sup>32</sup>-XX", where XX is the number of the Altitude<sup>32</sup>.

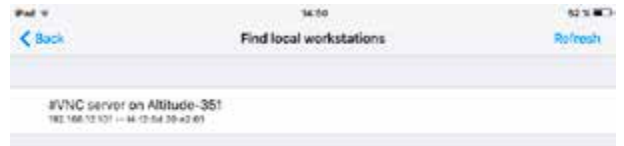

Figure 16: selecting the VNC Server Altitude<sup>32</sup>-XX

The field VNC server address now shows the name "#VNC Server on Altitude<sup>32</sup>-XX", where XX is the number of the Altitude<sup>32</sup>. Go to the field VNC password and enter the password, which is the six-digit serial number of the Altitude<sup>32</sup>:

- the password is 00000X if the number of the Altitude<sup>32</sup>'s VNC Server has a single digit;
- the password is 0000XX if the number of the Altitude<sup>32</sup>'s VNC Server has 2 digits;
- the password is 000XXX if the number of the Altitude<sup>32</sup>'s VNC Server has 3 digits;
- etc...

The VNC Server is now configured.



Figure 17: entering the password

Now, click on the Connect menu item. The "#VNC Server on Altitude<sup>32</sup>-XX" should be listed in the page. Select the line "#VNC Server on Altitude<sup>32</sup>-XX". The graphical user interface of your Altitude<sup>32</sup> should now be visible on the screen of your device.



Figure 18: connecting to the Altitude<sup>32</sup>'s VNC server

## 2.1.5 \_USING A MAC OS X COMPUTER WITH THE TRINNOV APP

The easiest way to connect to your device is the use the Trinnov App. It allows remote control for all trinnov machines.

It's a very easy and efficient tool that will provide you access to the user interface with just a couple of clicks.

Go to the Trinnov website and go to « Support ». On that page, the Trinnov App will be available to download on your computer. After downloading the Trinnov App, simply open it and choose which unit you want to connect to on the left column. Then, hit « connect ».

The interface is now displayed on the screen . The detection process uses either a ZeroConf/Bonjour standard or a proprietary broadcast packet. If no machine is detected, due to network restrictions, it is still possible to manually enter an IP address by entering the informations in the "connect to" field.

The control protocol between the machine and this application uses the standard HTTP port 80 that must be authorized if your network is under control. If you want to use the EUCON feature of the application, the corresponding checkbox must be selected to register the Trinnov inside the workstation EUCON service.



NOTE:

You can download the Trinnov App using the following link: <https://www.trinnov.com/support>

## 2.1.6\_USING A MAC OS X COMPUTER WITH SCREEN SHARING

To connect to the Altitude<sup>32</sup>'s VNC Server from your Mac OS X computer, you can use the integrated Screen Sharing VNC client included since OS X version 10.5 (Leopard):

Open the Finder application in your Mac OS X computer.

Select the item Go > Network in the Finder's menu. This will display the available VNC servers in your network.

Select the server "VNC server on Altitude<sup>32</sup>-XX", where XX is the number of your Altitude<sup>32</sup>. This will display the following window

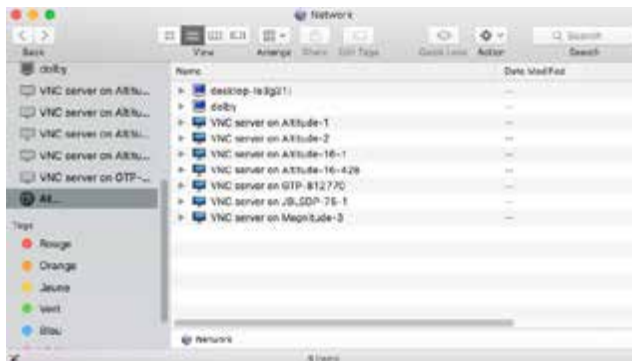

Click on the Share Screen... button. This will display the Screen Sharing login panel

Enter the password, which is the six-digit serial number of your Altitude<sup>32</sup>:

- the password is 00000X, if the number of your Altitude<sup>32</sup>'s VNC Server has a single digit;
- the password is 0000XX if the number of your Altitude<sup>32</sup>'s VNC Server has 2 digits;
- the password is 000XXX if the number of your Altitude<sup>32</sup>'s VNC Server has 3 digits;
- etc...

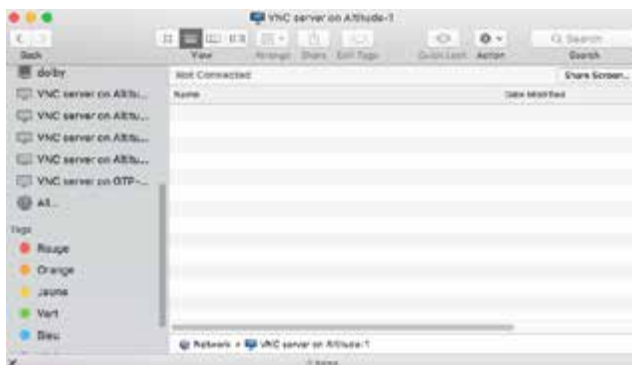

Click on the Connect button located in the lower left corner of the window.

The graphic user interface of the Altitude should now be visible on the screen of your Mac.

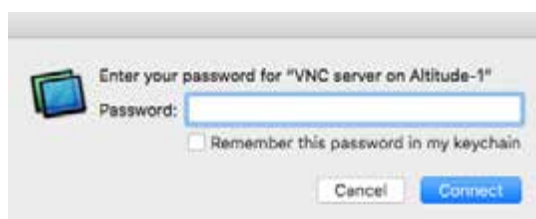

The graphical user interface of your Altitude<sup>32</sup> should now be visible on the screen of your Mac.



## 2.1.7 \_USING A MAC OS X COMPUTER WITH CHICKEN OF THE VNC

To connect to the Altitude<sup>32</sup>'s VNC Server with the Chicken of the VNC client from a Mac OS X computer:

1. The VNC Login window shows a list of available VNC servers. Select the server “VNC server on Altitude<sup>32</sup>-XX”, where XX is the number of your Altitude<sup>32</sup>.

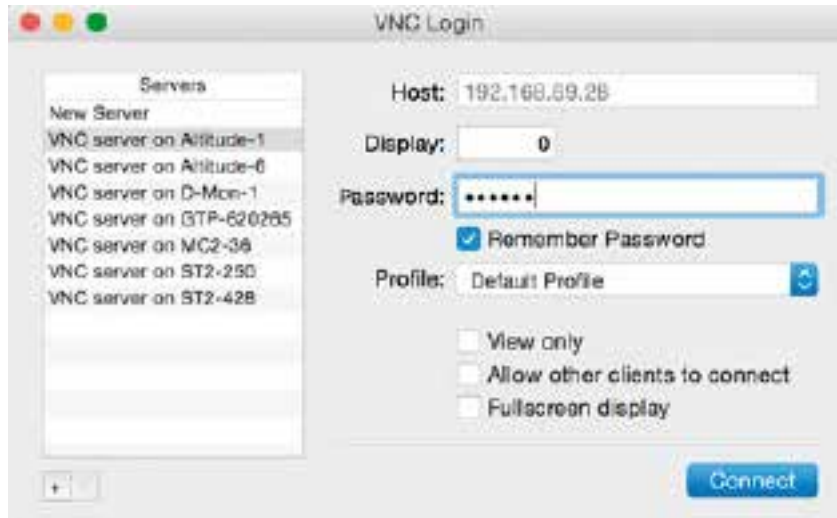

Figure 19: Chicken of the VNC Login window

2. The Host's IP address is automatically filled. You only need to enter the password, which is the six-digit serial number of your Altitude<sup>32</sup>:
  - the password is 00000X, if the number of your Altitude<sup>32</sup>'s VNC Server has a single digit;
  - the password is 0000XX if the number of your Altitude<sup>32</sup>'s VNC Server has 2 digits;
  - the password is 000XXX if the number of your Altitude<sup>32</sup>'s VNC Server has 3 digits;
  - etc.
3. Click on the Connect button located in the lower left corner of the window.
4. The graphical user interface of your Altitude<sup>32</sup> should now be visible on the screen of your Mac.

## 2.1.8 \_USING A WINDOWS COMPUTER WITH TIGHT VNC

Since Tight VNC is not a zero-conf client, the connection procedure requires some additional steps, which are described below.

### \_WRITE DOWN YOUR ALTITUDE<sup>32</sup>'S SERIAL NUMBER

1. Go to your Altitude<sup>32</sup>'s back panel to find out its serial number. The 6-digit serial number is printed above the MADE IN FRANCE tag: it is “000008” in the example below:
2. the VNC password is the six-digit serial number of your Altitude<sup>32</sup>:



Figure 20: a serial number as printed on the back panel of the Altitude<sup>32</sup>

- The password is 00000X, if the number of your Altitude<sup>32</sup>'s VNC Server has a single digit;
- The password is 0000XX if the number of your Altitude<sup>32</sup>'s VNC Server has 2 digits;
- The password is 000XXX if the number of your Altitude<sup>32</sup>'s VNC Server has 3 digits;
- Etc...

## \_WRITE DOWN THE IP ADDRESS OF THE ALTITUDE<sup>32</sup>

If your VNC client is not zeroconf-enabled, it cannot find the Altitude<sup>32</sup>'s VNC Server automatically. This is the case for the Tight VNC client for Windows. Therefore, you'll need to enter the Altitude<sup>32</sup>'s IP address in the connection window. More precisely, the IP address you need to enter is the IP address of the Ethernet interface.



NOTE:

**the IP address of the Altitude<sup>32</sup> can be retrieved:**

- via the front panel in the **Setup/Network/Ethernet** page;
- from the **Network** page of the graphical user interface displayed to a monitor via the VGA or DVI port.

## \_GETTING THE IP ADDRESS FROM THE ETHERNET SETTINGS

To get the IP address from the Ethernet settings via the front panel:

Click on the menu button. Select the Setup > Network > Ethernet page. Turn the Source/Item selection knob to scroll through the settings.



Figure 21: IP address in the Setup > Network > Ethernet page via the front panel

## \_CONNECT WITH TIGHT VNC

First of all, use the Altitude<sup>32</sup>'s front panel display to find out the IP address of its VNC Server (see the detailed explanation above).

To connect with your VNC client to the Altitude<sup>32</sup>:

Open the Tight VNC software in your Windows computer.

1. In the VNC client's connection window, enter the IP address of the Altitude<sup>32</sup>'s VNC Server (see the detailed explanation above),
2. Click on the Connect button. This will open the VNC Authentication window:
3. In the VNC Authentication window, enter the password, which is the six-digit serial number of your Altitude<sup>32</sup>, printed on the back panel.
  - a. The password is 00000X, if the number of your Altitude<sup>32</sup>'s VNC Server has a single digit;
  - b. The password is 0000XX if the number of your Altitude<sup>32</sup>'s VNC Server has 2 digits;
  - c. The password is 000XXX if the number of your Altitude<sup>32</sup>'s VNC Server has 3 digits;
  - d. Etc...
4. Once you've entered the correct password, the Altitude<sup>32</sup>'s graphical user interface will be displayed.

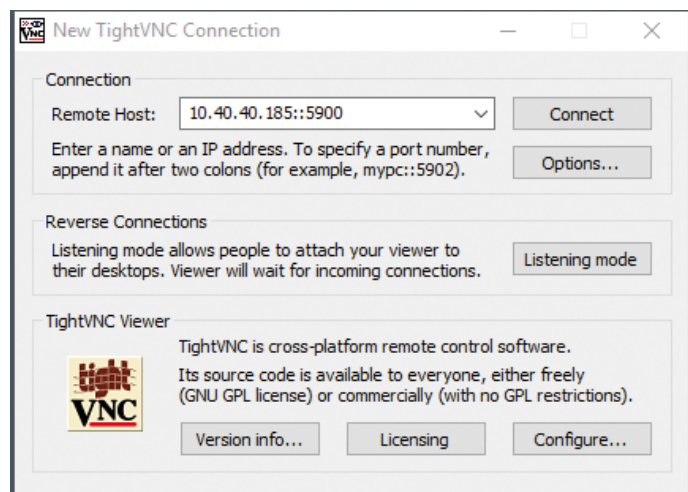
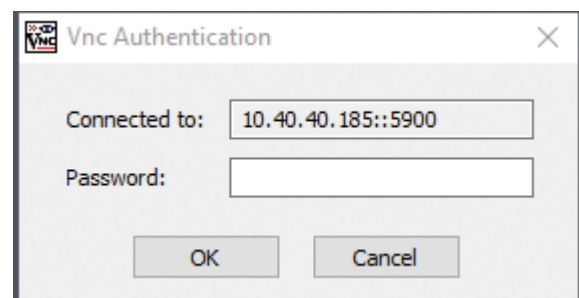

Figure 22 the New TightVNC Connection panel on a Windows computer



## 2.2 \_CHANGING THE NETWORK SETTINGS THROUGH THE FRONT PANEL

### 2.2.1 \_CHECKING THE WI-FI SETTINGS

To check the Wi-Fi settings via the front panel:

- Click on the menu button
- Go to the Setup > Network > Wifi page:  
Turn the Source/Item selection knob to scroll through the settings.



- Setup > Network > Ethernet page via the front panel

### 2.2.2 \_USING DHCP

The DHCP (Dynamic Host Configuration Protocol) is a standardized network protocol used on Internet Protocol (IP) networks. The DHCP server dynamically distributes network configuration parameters (IP addresses, netmask etc...).

You can activate the DHCP (on) if the Altitude<sup>32</sup> is plugged to the network with an Ethernet cable. Most cases, all the network fields will be field in automatically.

## 2.3 \_CHANGING THE ETHERNET SETTINGS THROUGH THE GUI

This subchapter explains how to change the Ethernet settings of the Altitude<sup>32</sup> to meet the requirements of your home theater's technical environment.

### 2.3.1 \_ABOUT THE ETHERNET INFORMATION

The following Ethernet information is available in the Altitude<sup>32</sup>:

- **Status:** indicates the connection status of the Ethernet interface of the Altitude<sup>32</sup>
- **MAC address:** indicates the MAC address of the network interface of the Altitude<sup>32</sup> (required to remotely switch the Altitude<sup>32</sup> on with a Wake-on-Lan command).
- **IP address:** indicates the IP address of the Ethernet interface of the Altitude<sup>32</sup>.
- **Netmask:** indicates the netmask of the local area network joined as a DHCP client via Ethernet.
- **Gateway:** indicates the address of the Gateway for network interconnection.

## 2.3.2 \_CHECKING THE ETHERNET SETTINGS

The network information can be retrieved from the Graphical User Interface of the Altitude<sup>32</sup>:



Figure 23: Ethernet Network Interface Information

**!** NOTE: Network settings can only be changed through the Advanced Settings interface of the Altitude<sup>32</sup>. Go to the Setup/Network page to change the Ethernet settings.

## 2.3.3 \_CHANGING THE ETHERNET SETTINGS

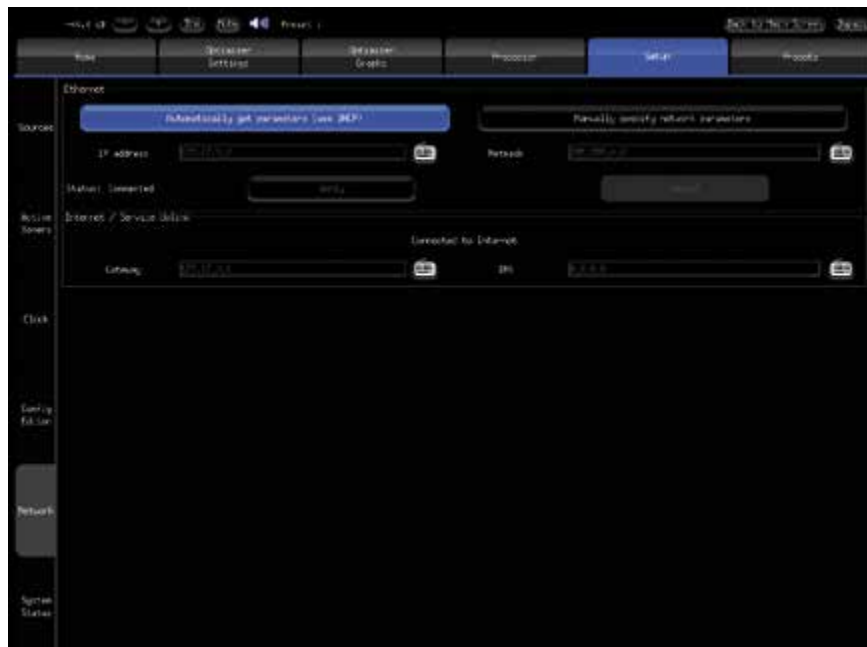

Figure 24: Ethernet Network Interface Information

The default mode of the Ethernet interface of the Altitude<sup>32</sup> is DHCP, meaning that the Altitude<sup>32</sup> will automatically be detected and configured by the router, provided that the router runs a DHCP server. This is the case in most domestic environments.

To configure the Ethernet connection manually, select the **Manually specify Network parameters** option and hit **Apply**.



The IP address, Netmask, Gateway and DNS option can then be edited manually.

Applying new settings with the Apply button is required for every change.

**!** NOTE: It is recommended to refer to an IT specialist before switching to manual configuration.

## 2.4 \_ABOUT VNC AND ZERO-CONF NETWORKING

The Altitude<sup>32</sup> leverages two important networking technologies: VNC and zero-configuration networking, which are explained below.

### 2.4.1 \_ABOUT VNC (VIRTUAL NETWORK COMPUTING)

VNC is a graphical desktop sharing system that transmits keyboard and mouse events from one computer (server) to another (client), relaying the graphical screen updates back in the other direction, over a network.

The Altitude<sup>32</sup> has a built-in VNC Server that allows you to access its graphical user interface over a network from any device running a VNC client.

**!** NOTE: to learn more about VNC, please read the following article on Wikipedia: [http://en.wikipedia.org/wiki/Virtual\\_Network\\_Computing](http://en.wikipedia.org/wiki/Virtual_Network_Computing)

### 2.4.2 \_ABOUT ZERO-CONFIGURATION NETWORKING

Zero configuration networking (zeroconf) is a networking technology that makes it easy to set up, use devices and services on a network. Because zeroconf-enabled devices indicate their availability, it's easy for you (or an app or service) to find gadgets that you want to use.

The Altitude<sup>32</sup>'s VNC Server is zeroconf-enabled in order to indicate its availability to the zeroconf-enabled VNC Client running on your device (tablet or computer).

The two major implementations used in VNC client apps are:

- The Bonjour protocol, developed by Apple Inc. It is available in free VNC clients such as Mocha VNC Light (for iOS and Android devices) and Chicken of the VNC (for Mac OS X).
- Avahi, for the Linux operating system.

Microsoft has its own proprietary protocol for remote computing: RDP (Remote Desktop Protocol). This explains why there is no major implementation of the zeroconf technology on the Windows platform.

**!** NOTE: to learn more about Zero-configuration networking, please read the following article on Wikipedia: [http://en.wikipedia.org/wiki/Zero-configuration\\_networking](http://en.wikipedia.org/wiki/Zero-configuration_networking)

# 3 \_NETWORK STREAMING

## 3.1 \_THE UPNP PROTOCOL

The Altitude<sup>32</sup> network streamer feature is based on the Universal Plug and Play (UPnP) set of networking protocols. In the UPnP/DLNA terminology, the Altitude<sup>32</sup> is a UPnP Digital Media Rendering device and is used as slave equipment to play media content sent through the network.

The Altitude<sup>32</sup> must be used with DLNA/UPnP compatible server and controller devices. The Media Server shares its media library on the network with UPnP clients. The Media Controller is the master gadget used to automatically detect servers, play files on slave devices as well as to control them.

Provided that the server supports these formats, the Altitude<sup>32</sup> can decode and play high-resolution 24 bit/96 kHz WAV, AIFF, FLAC, 16 bit/96 kHz OGG music files.

## 3.2 \_UPNP NETWORK ARCHITECTURE

This architecture represents the most common and comfortable method to play media files in a domestic environment:

- A Network-Attached Storage (NAS) or a computer is used as UPnP server and shares the media library.
- The library is browsed from a Media Controller, installed on a tablet or smartphone.
- The Altitude<sup>32</sup> is selecting a rendering device from the Media Controller

! NOTE: Most NAS are UPnP compatible servers but any computer can be turned into a server provided that a compatible UPnP server software is installed.  
Several applications can turn smartphones and tablets into media controllers or servers.

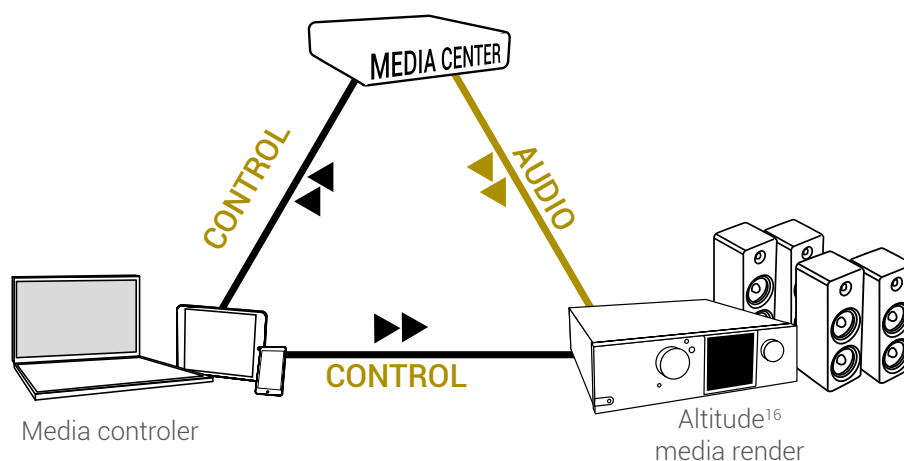

*UPnP Network with a Digital Media Controller*

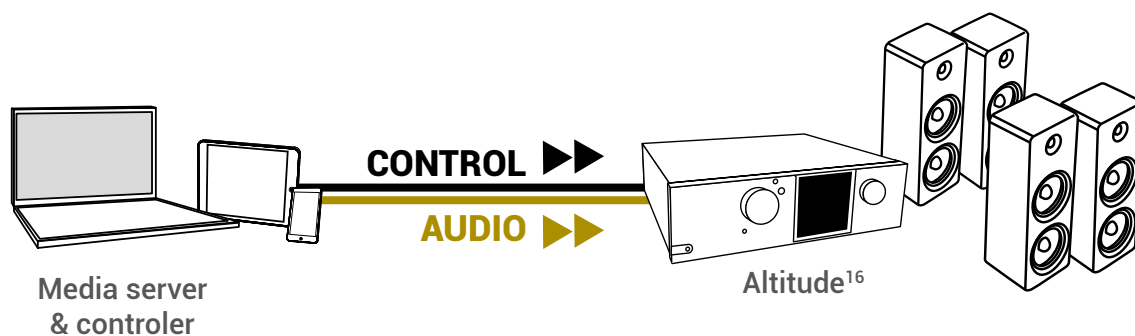

*UPnP Network with a device used as server and controller*

### 3.3 \_RECOMMENDED UPNP SOFTWARES

The Alitude<sup>16</sup> is a UPnP renderer. Unlike a UPnP player, the Alitude<sup>16</sup> cannot be used to browse a library, create playlists nor control audio playback.

That's why we have established a shortlist of UPnP third-part software optimized for audio.

## JRiver

### MediaCenter

This software has been selected, tested and qualified based on the following requirements.

- ✓ UPnP server and controller
- ✓ 24 bits/96kHz playback
- ✓ Bit Perfect Streaming
- ✓ WAVE AIFF FLAC OFF support
- ✓ Album cover art display
- ✓ User-friendly graphical user interface

## JRiver

MediaCenter ([www.jriver.com](http://www.jriver.com))

JRiver Media Center is a comprehensive media player and UPnP platform that can be used as both server and controller.

This software is therefore well-suited to the Alitude<sup>32</sup>.

JRiver Media Center is a commercial software available for PC and Mac.

•DOWNLOAD > [www.jriver.com/download.html](http://www.jriver.com/download.html)



• Server  
• &  
• Controller

## 3.4 \_USING ROON

### 3.4.1 \_GETTING STARTED WITH ROON

Roon transforms the experience of browsing music. Artist photos, credits, bios, reviews, lyrics, tour dates, and composers are located automatically, then interconnected by links to build a surfable, searchable digital magazine about your music collection.

Roon also finds all the same links between your personal files and the millions of tracks available on Tidal and Qobuz.

You can start with the music you know, then explore and discover new music from the world beyond your collection.

Roon is an incredibly rich and engaging way to browse and organize your music. It runs on most Mac, Windows, Linux or on other products which include Roon Core.

Being Roon Ready means that Trinnov Audio's network players transparently discover and connect to Roon Application without any configuration and bit-perfect audio is delivered from Roon to your network player. It also allows us to employ the high-quality clocks built into your Trinnov products rather than depending on inferior, external clocks that can compromise the ultimate sound quality.

Together, Roon and Trinnov Audio deliver the power, flexibility and performance of networked audio with the easiest setup, highest reliability and highest performance available.



•Server  
•&  
•Controller





### 3.4.2 \_IMPORTANT RECOMMENDATION

To use your Altitude<sup>32</sup> with Roon in the safest way, we strongly recommend that you define a maximum volume that will prevent sending +20dB in your speakers.

To do so, please click on “Info” on the left button of the main screen of the Altitude.

Then go to Startup.

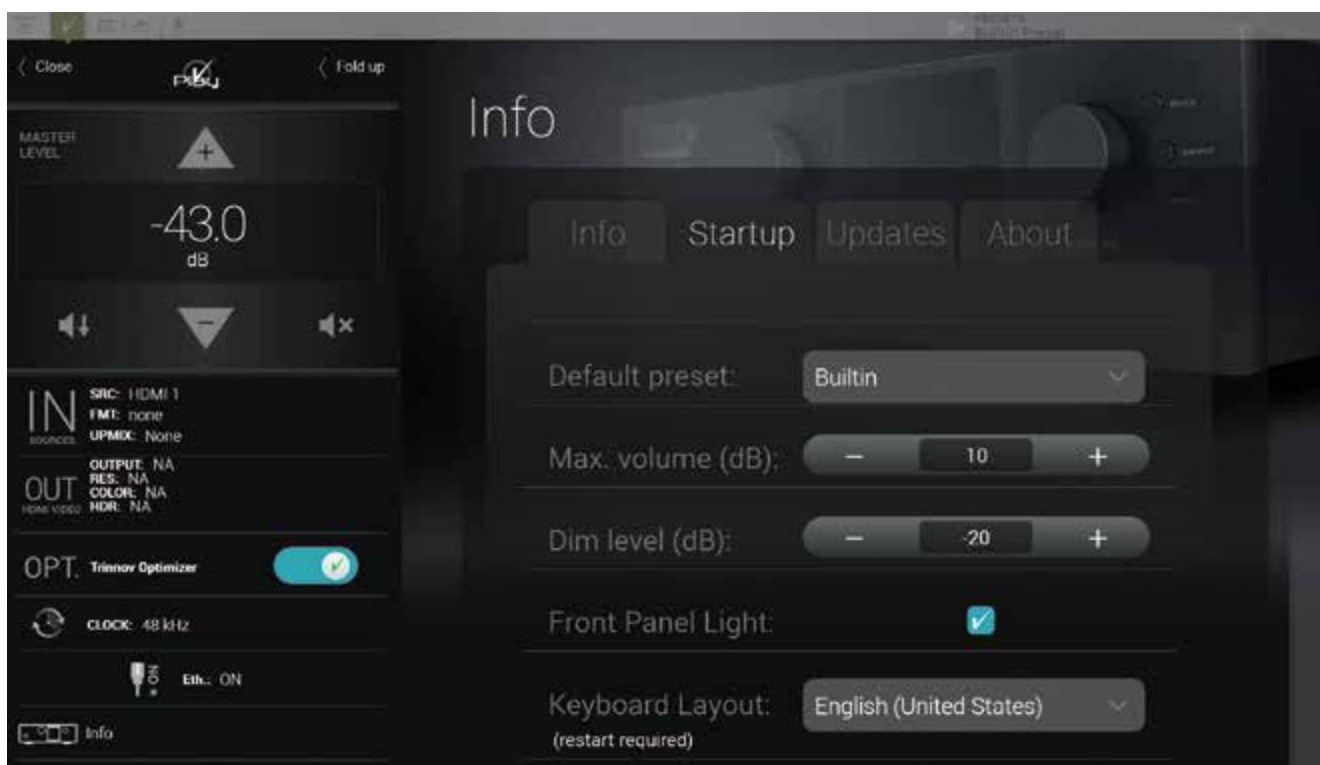

Figure 25: Setting the maximum volume on the Altitude<sup>32</sup>

Here you can set your maximum volume (Max. volume (dB)). We recommend to set it to the maximum volume you usually listen to. By that way you will protect your speakers (and your ears). Also, the volume slider of Roon will be more precise.

If you don't know the maximum usual listening level, setting the “Max Volume” at -20dB will be a good start.

### 3.4.3 \_ALTITUDE<sup>32</sup> IS ROON READY

The Roon Ready source is directly available on the main page of the user interface. Directing a song to be played on your Altitude from any Roon controller will automatically select the Roon source on the Altitude (as shown on the screenshot below). Note that you can also control the volume of the Altitude from the same Roon controller application.

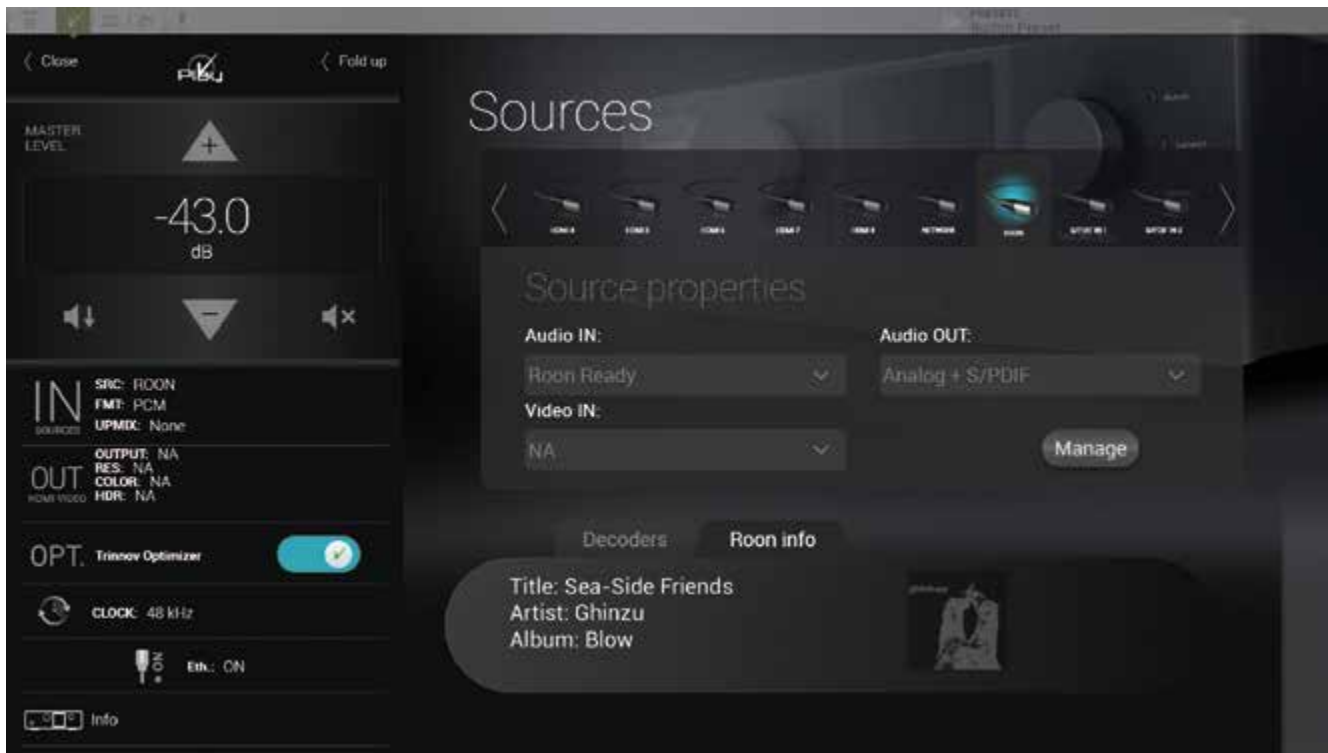

Figure 26: Altitude<sup>32</sup> connected to Roon

# 4 \_DAILY OPERATIONS

This chapter explains how to perform daily operations on the Altitude<sup>32</sup> such as:

Volume control / Source selection / Preset selection...

These operations can be performed:

Via the front panel / Via the IR remote control / Via the graphical user interface.

## 4.1 \_AVAILABLE USER INTERFACES

Simple daily operations on the Altitude<sup>32</sup> can be performed:

- On the front panel, by turning the Source/Item selection knob and pushing the Select button to scroll through the menus;
- With the infrared remote control;
- From your tablet or your computer connected to the same network as the Altitude<sup>32</sup>;
- with a VNC Client connected to the Altitude<sup>32</sup>'s VNC Server;
- with a web browser accessing the Altitude<sup>32</sup>'s web-based interface;
- With a display, a mouse and a keyboard directly connected to the Altitude<sup>32</sup>'s back panel.



NOTE:

- For a detailed step-by-step explanation of how to connect with a VNC Client, please see the subchapter First Network Connection to the Altitude<sup>32</sup> in the Network Setup chapter.
- Further details about the web interface are provided in the Introduction chapter of this document.
- For additional details about connecting a display, a mouse and a keyboard, please refer to the Introduction chapter at the beginning of this document.

## 4.2 \_USING THE FRONT PANEL

### 4.2.1 \_POWER ON-OFF SEQUENCE



IMPORTANT NOTE: As with any audio system, the power amplifiers should be powered on last

Turn On the **main power switch on the rear panel** to supply the Altitude<sup>32</sup> with power, then press the **front panel power button** to start the Altitude<sup>32</sup>.



NOTE: The system doesn't start instantly and takes about **60 seconds to complete its start-up**

While the system starts, the front panel screen displays the following image.



Figure 27: Front panel startup image

To shut the Altitude<sup>32</sup> down, press the front panel power button once. The front panel screen will then display the following image until complete shutdown.



Figure 28: Front panel shut down image



NOTE: It is not recommended to cut the AC Power via the main power switch on the rear panel, as the system saves several "last-used" settings while shutting-down.

VOLUME CONTROL	SOURCE SELECTION	PRESET SELECTION
<ul style="list-style-type: none"> <li>•Turning the <b>Volume Control knob</b> to the right or left will respectively turn the volume up or down.</li> <li>•Push the <b>Mute button</b> to mute all audio outputs of the Altitude<sup>32</sup>.</li> </ul>	<ul style="list-style-type: none"> <li>•There are two methods to select sources from the front-panel on the Altitude<sup>32</sup>:</li> <li>•Turn the <b>source selection knob</b> to scroll through sources and push the select button.</li> </ul> <div data-bbox="569 1429 987 1563" style="border: 1px solid black; padding: 5px; margin-top: 10px;"> <p> NOTE: With factory settings, the last-used source is recalled on start-up.</p> </div>	<ul style="list-style-type: none"> <li>•In order to select a preset through the front-panel menus:</li> <li>•Push the <b>Menu</b> button, scroll until Presets and push the Select button.</li> <li>•Select the required preset using the <b>Source Selection Knob</b> and push the Select button.</li> </ul>



### 4.2.2 \_CHECKING THE FORMAT OF INCOMING AUDIO

The format of the incoming audio of the currently selected source is displayed on the front panel display of the Altitude<sup>32</sup> below the Optimizer status.

The Sampling Rate of the audio being played is indicated on the left side of the front panel display of the Altitude<sup>32</sup>.

The current Upmixer used is shown on the front panel display on the Altitude<sup>32</sup> below the sampling rate.



Figure 29: Altitude<sup>32</sup> front panel display

## 4.3 \_USING THE IR REMOTE CONTROL

### 4.3.1 \_VOLUME CONTROL

The following volume control buttons are available on the IR Remote control



### 4.3.2 \_SOURCE SELECTION

The IR remote control includes 4 buttons for direct source selection, as well as 2 buttons to browse through the sources



### 4.3.3 \_LISTENING FORMAT SELECTION

This allows you to switch between the different listening format and between the different Upmixers. This can be done on the fly. You do not need to press OK to validate.



### 4.3.4 \_PRESET SELECTION

Switching presets:

1. Browse through the presets with the Optimizer Preset arrow buttons.
2. Push the OK button.



### 4.3.5 \_ACCESS TO THE FRONT PANEL MENU

To access the Menu:

1. Press on **Menu** button to access to the Menu
2. Browser with **◀ Left, ▶ Right, ▲ up and ▼ down** arrows
3. Confirm with the **OK** button
4. Return with the **Back** button



### 4.3.6 \_LIGHT BUTTON

Use this button to turn On/Off the front panel display



### 4.3.7 \_OPTIMIZER BYPASS

The **Bypass** button allows you to toggle speakers/room Optimizer on and off.



## 4.4 \_USING THE GRAPHICAL INTERFACE

### 4.4.1 \_VOLUME CONTROL

The following volume control options are available within the graphical user interface.



A Mute button allows you to mute all audio outputs of the Altitude<sup>32</sup>.

A Dim button allows you to decrease the volume by 20dB (on a default configuration).

NOTE: The last used by default

### 4.4.2 \_SOURCE SELECTION

Sources can be selected through the graphical user interface by clicking on the icon:

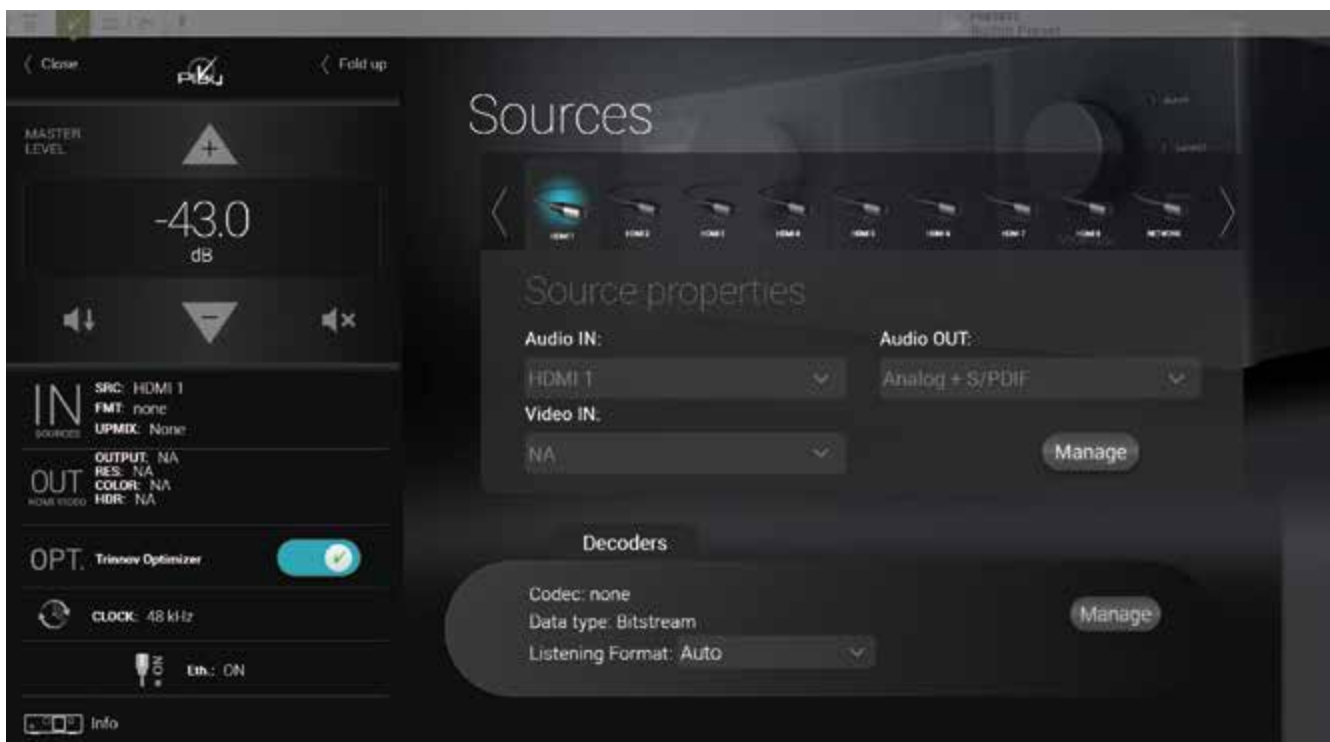

Figure 30: The source selection page in the graphical user interface



### 4.4.3 \_PRESET SELECTION

Presets can be selected through the graphical user interface:

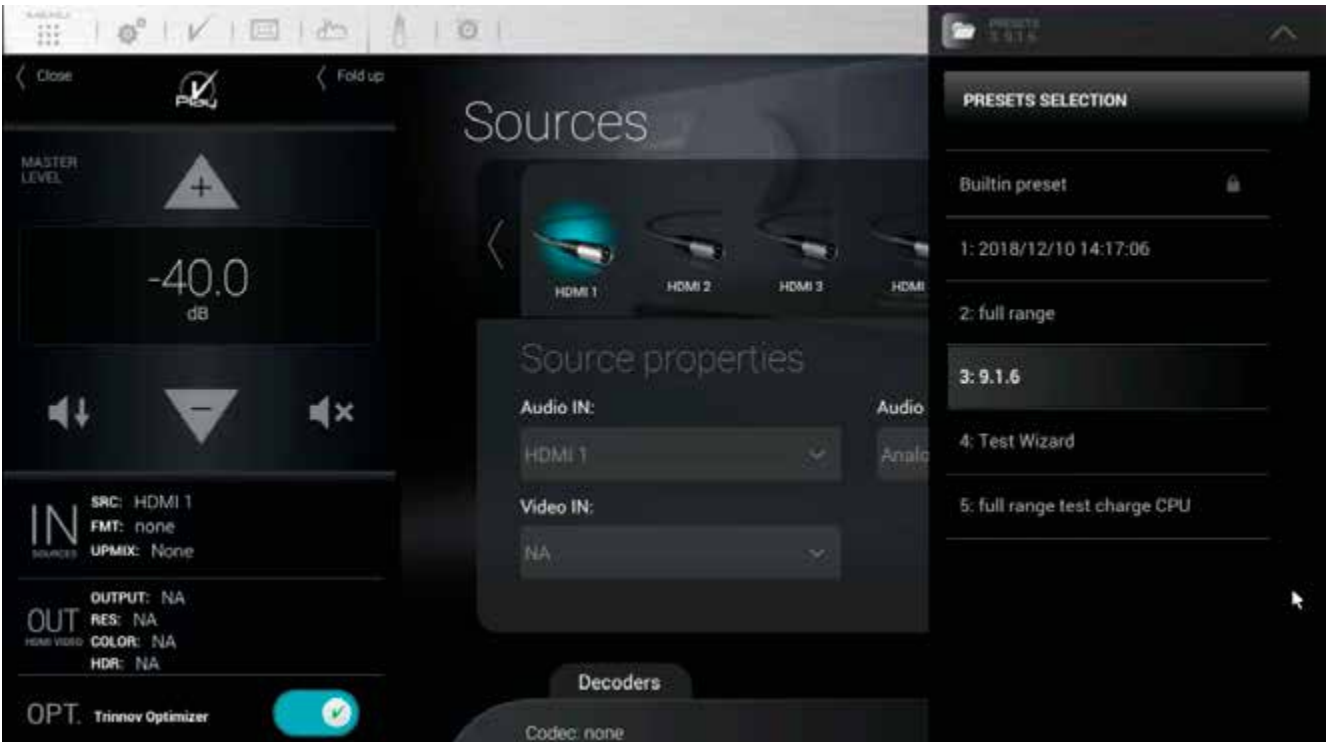

Figure 31: preset selection in the graphical user interface

### 4.4.4 \_CHECKING THE FORMAT OF INCOMING AUDIO

The format of incoming audio is displayed in the lateral menu bar and in the **Sources** page of the **Main** user interface:

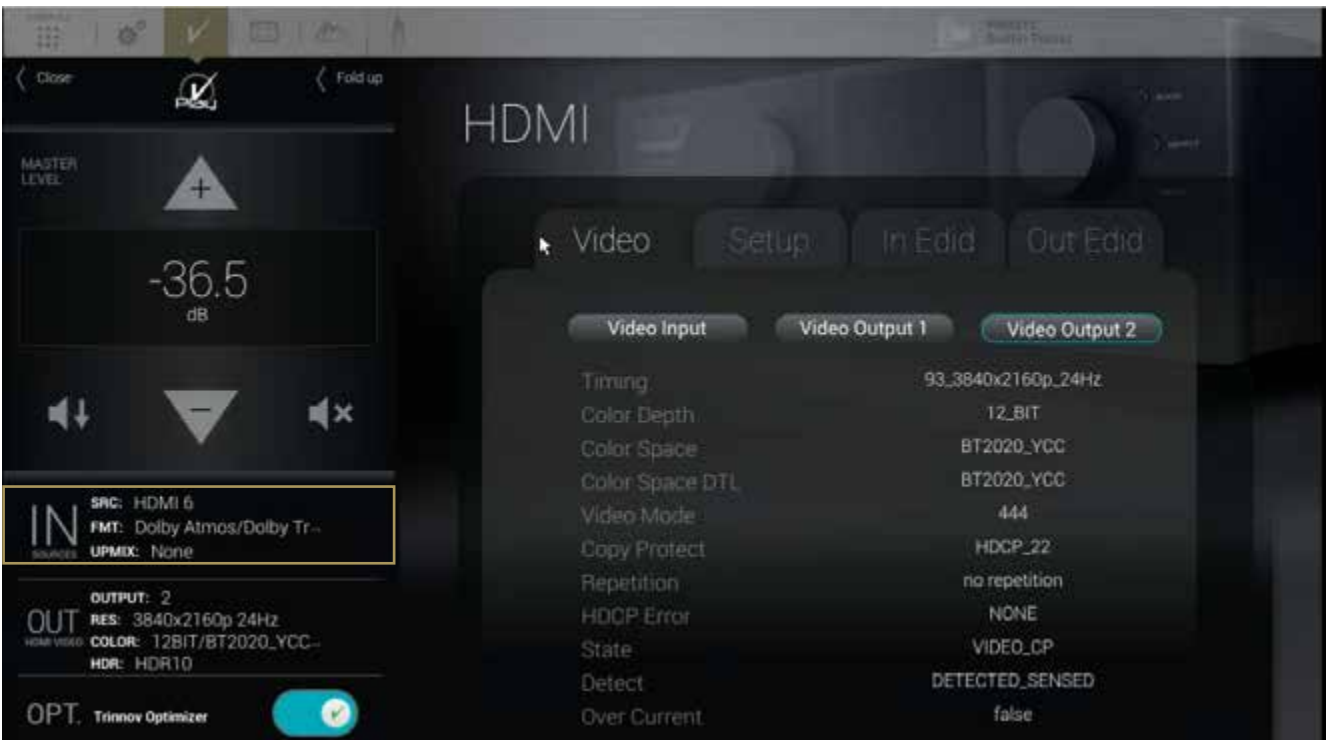

Figure 32: checking the audio format via the user interface

# 5 \_BASIC SETTINGS

## 5.1 \_NAMING YOUR SOURCES

The Altitude<sup>32</sup> provides very flexible **Source Configurations**. Each **Source Configuration** can be renamed to reflect the actual source to which it corresponds. By default, the source names correspond to the names of the back panel connectors but can be edited in the **Home/Sources Config** page of the Advanced Settings Interface.

A Source Configuration can also include specific output and processing parameters. Therefore, it can be used to switch between outputs or between different processing settings. For example, it is possible to configure two Source Configurations set on the same input connectors but set with different names to recall different settings.

The Home/Source Config page consists of one vertical tab per source on the left and source-specific parameters on the right.

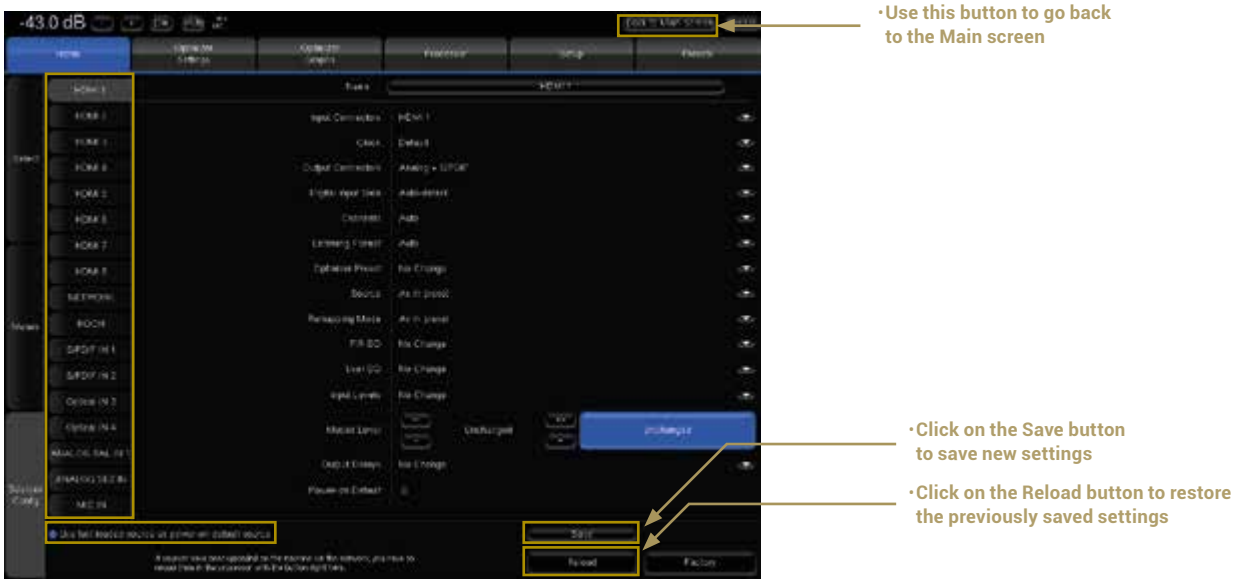

Figure 33: Source Configurations panel

**!** IMPORTANT NOTE: It is particularly important to define user friendly names for the first four sources because they are displayed on the front panel screen or from the IR remote control source selection buttons.



**!** IMPORTANT NOTE: Changes are not applied until saved via the Save button in the bottom right corner of the screen.

## 5.2 \_CONFIGURING YOUR SOURCES

In addition to an editable name, each Source Configuration includes several parameters to specify all the settings related to a specific configuration required for your system.

Source configurations can be used for different purposes:

- to switch between your different sources. For example: one Blu-ray player, one Network player and a Digital TV.
  - to switch between different outputs. For example: a pair of hi-fi loudspeakers and a 5.1 home cinema setup.
  - to switch between sources and outputs simultaneously. For example: play a vinyl record on the hi-fi loudspeakers and a blu-ray disc on the 5.1 home cinema system.
  - to recall different processing settings such as acoustic optimization filters, decoding modes or bass management modes.
- In order to change one of the parameters of the selected source configuration, click on the corresponding arrow:

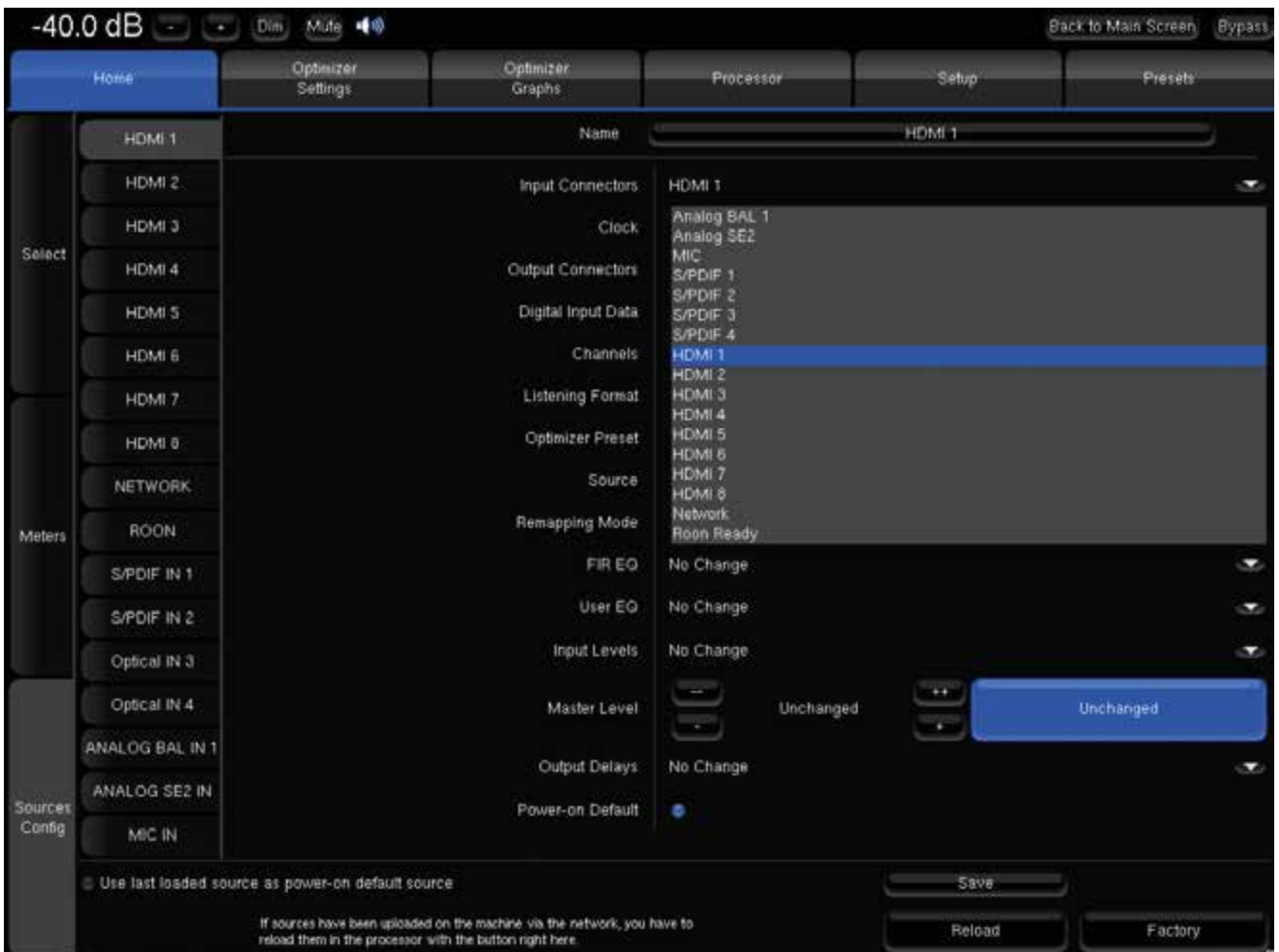

Figure 34: Editing a source configuration

The following settings can be configured for each of your **Source Configurations**:

- **Input Connectors:** select the rear panel input(s) in which your source is connected.
- **Clock:**
  - Default: the clock will run in master mode for analog inputs, in slave mode for digital inputs and in master mode for the network input.
  - Mast. XkHz: set the clock to different master clock sampling rates (32 kHz, 44.1 kHz, 48 kHz, 88.2 kHz or 96 kHz).
  - Sl. WC: set the clock to slave mode.
- **Output Connectors:** select the outputs that you want to use to play this source:
  - Analog + AES 1-8: analog outputs 1-32 ( depending upon your configuration ) and AES outputs 1-8 and 17-24 are active simultaneously;

- AML: Audio Multi Link is active;
- HDMI: HDMI outputs 1 & 2 are active simultaneously;
- AES OLD 1-16: old routing used in the prerelease models. Do not use.
- **Digital Input Data:**
  - Auto-detect: automatically detect whether the input is PCM or bit-stream;
  - Force PCM Audio: force the PCM audio format;
  - Force Bitstream Data: force the bitstream format to let the Altitude<sup>32</sup> decode the signal from the player.
  
- **Channels:** On non-HDMI source, you can select the channels you want to play
  - L,R
  - L,R,C
  - L,R,C,Lfe
  - L,R,C,Lfe,Ls,Rs
  - L,R,C,Lfe,Ls,Rs,Lrs,Rrs
  
- **Listening Format:** Select the default format you want to use with this source. The Altitude<sup>32</sup> will be forced to decode and upmix (if possible) in this format.
  - Auto: Will automatically upmix in the corresponding format;
  - Dolby Surround: Will force the Dolby Surround upmix;
  - Neural:X: Will force the DTS Neural:X upmix;
  - Auro-3D: Will force the Auro-3D upmix;
  - Native: keeps the incoming format from the source;
  - Upmix on native: Will automatically upmix in the corresponding format with the Legacy layout;
  - Legacy: Will only use the bed (5.1 or 7.1).
  
- **Optimizer Preset:** This parameter allows you to link a source to one of the presets you created.
  - No Change: no preset is associated to this source configuration;
  - 1 to 29: choose one of the 29 presets to load a preset when this source is selected;
  - The following parameters are set, by default, to use the settings from the current preset;
  - Source (the format of the source);
  - Remapping Mode.

For the following parameters, it is possible to choose between **No Change, As in preset** or to select one of the EQ created and saved in the Processor/Output page during the fine tuning:

- **FIR EQ:** Select a FIR EQ that has been saved in the **Processor/Output** page.
- **User EQ:** Select a FIR EQ that has been saved in the **Processor/Output** page.
- Input Levels
- Output Delays

The **Master Level** can be left Unchanged (default setting) or set to a specific level.

**Power-on Default:** the selected source can be set as the default configuration to be loaded at power-on. Alternatively, you can check the option **Use last loaded source as power-on default source** in order to keep the source that was used before the last shut-down.

### 5.3 \_DEFAULT SOURCE CONFIGURATION

With factory preset, the Altitude<sup>32</sup> uses the last loaded source as power-on default source. This can be modified in the Home/Sources Config page of the Advanced Settings Interface:

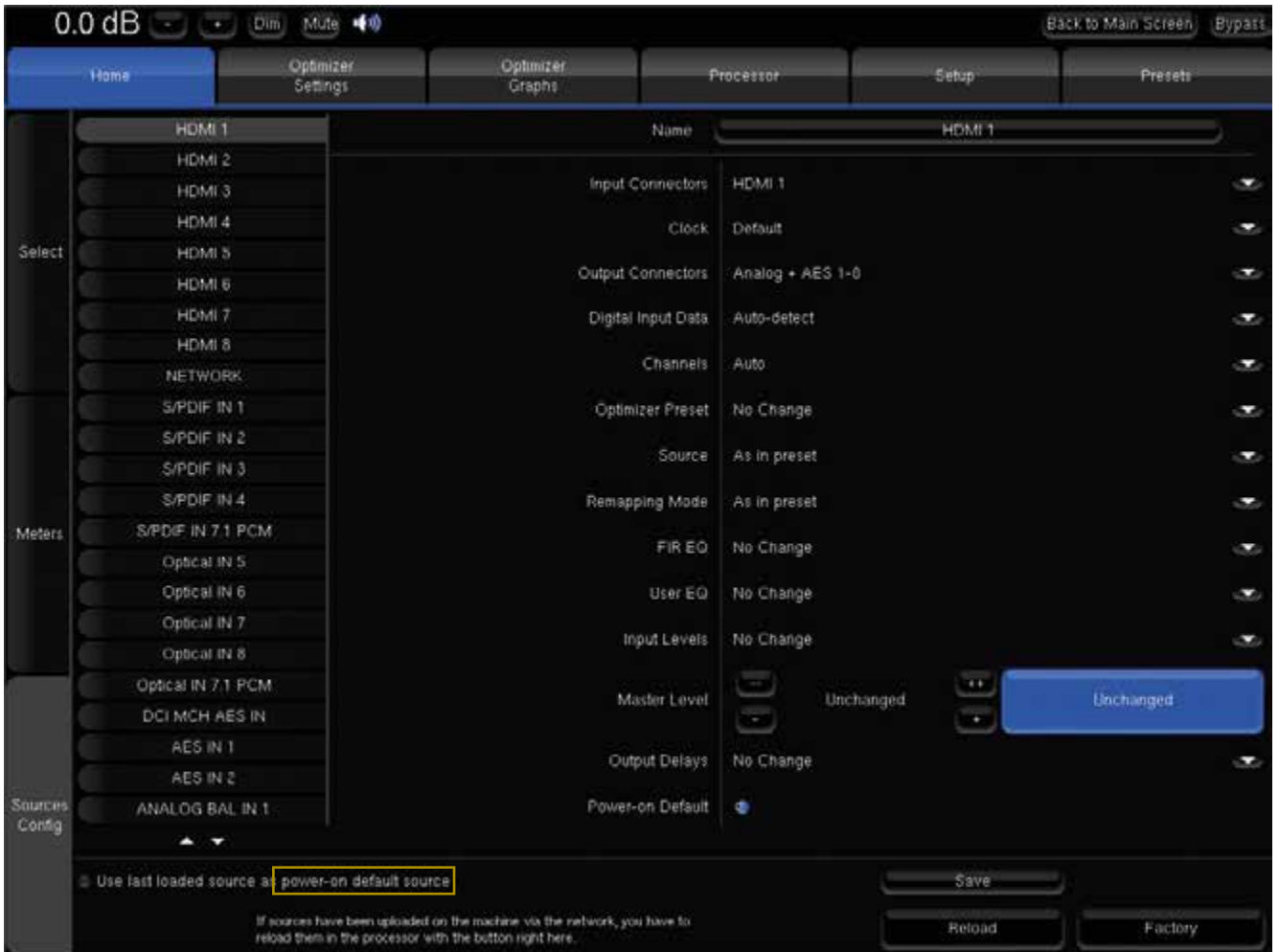

Figure 35: Default Source

Select the vertical tab of the source you want to use as default source. Tick the **Power-on Default** checkbox. Press the **Save** button to apply the new parameter of the source.

## 5.4 \_OPTIMIZATION OPTIONS

The Altitude<sup>32</sup>'s optimization of the system can be switched on/off via the Main interface.

To switch on/off the optimization options, click on the "OPT. Trinnov Optimizer" menu item of the lateral menu. The following Optimization options are available in this page:

- To activate/deactivate all of the Optimizer processing:
  - The Trinnov Optimizer switch
- To activate/deactivate specific parts of the processing:
  - The Acoustic correction switch
  - The Level alignment switch
  - The Delay alignment switch

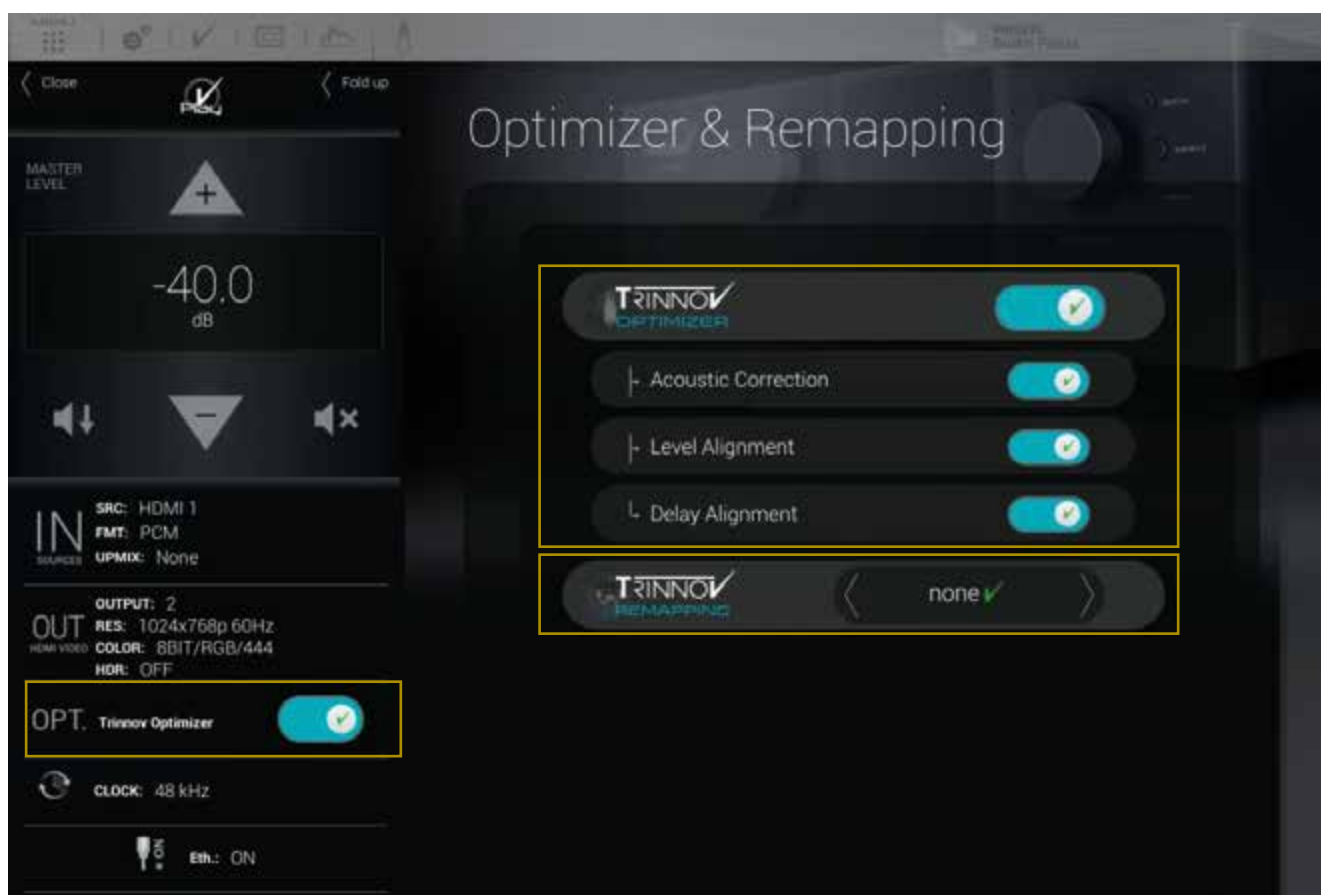

Figure 36: Optimizer & Remapping page

- Trinnov Optimizer ON/OFF: switch on/off the automatic correction of the in-room response: the acoustic correction, the automatic delay and level alignment as well as the remapping options. When the Optimizer is off, only the manual settings related to the audio processor are applied:
  - Routing, as defined in Speaker Configuration Table in the 3D View page of the Main interface;
  - The Active Xovers frequencies and filters;
  - Levels, as defined in the Processor pages of the Advanced interface;
  - Graphic EQs, as defined in the Processor pages of the Advanced interface;
  - Bass Management, as defined in the Fine Tuning page of the Main interface.
- Acoustic Correction ON/OFF: when turned off, both the automatic equalization (defined by the target curve) and the FIR EQs (defined in the Processor/Outputs page of the Advanced interface) are bypassed;
- Level Alignment ON/OFF: disable the automatic alignment of speaker levels, meaning that no automatic gain changes will be applied to the outputs;
- Delay Alignment ON/OFF: disable the automatic alignment of speaker distances, meaning that no automatic delays will be applied to the outputs.

## 5.5 \_REMAPPING OPTIONS

The Trinnov Remapping selection box provides the following speaker remapping options:

- Off: no speaker remapping
- Matrix: Manually define the remapping (Advanced user only)
- Automatic Routing: the remapping engine automatically routes each channel to the correct speaker
- 2D Remapping: the remapping is applied in the horizontal plane
- 3D Remapping: full 3D remapping, including the horizontal plane and elevation

**!** NOTE: the 2D remapping consider every speakers on the same elevation plan. This may result in strange remapping behavior with speakers in elevation and is not recommended for use with Immersive Audio systems.

**!** NOTE: Speaker remapping is independent from surround upmixing.

## 5.6 \_NAMING, SAVING AND LOADING PRESETS

The Altitude<sup>32</sup> can store up to 29 memory presets. Presets can be managed in the Presets menu of the Advanced Settings Interface



Figure 37: Presets 1-9 page

The most important parameters included in a preset are:

- The acoustic measurements and corrections
- The settings of the acoustic filters
- The output configuration and routing

**IMPORTANT NOTES:**

- Except for sources settings, consider that everything is saved in a preset.
- Any parameter change will be lost if not saved in a preset.
- Please manipulate presets with care since overwriting a preset does not require confirmation.

The Presets page consists of four vertical tabs:

- Presets 1-9: includes the Built-in preset and presets 1 to 9
- Presets 10-19: includes presets 10 to 19
- Presets 20-29: includes presets 20 to 29
- Preset Info: shows the current preset information

Each Preset tab consist of the following items:

- The Preset name field: used to enter or modify a preset's name.
- 10 memory slots including from left to right:
  - The Preset name/number, greyed out when the slot is empty, highlighted in blue when the preset is selected.
  - A Clear button to clear the memory slot. This function irreversibly deletes the preset's parameters.
  - A Save button to save current parameters as a preset in the memory slot.
  - A Lock checkbox to protect the preset: disables the Clear & Save buttons.
  - A Def (for default) checkbox to automatically load the preset as default after start-up.

As an example, the recommended procedure to duplicate a preset and copy it in a different memory slot would be to:

1. Reload the preset to recall the exact configuration you want to duplicate.
2. Use the Save button of an empty preset to copy it.

**NOTES:**

- The Built-in preset is locked and cannot be overwritten.
- A specific preset can be linked to each source. Please refer to the Basic Settings chapter.
- Presets can be backed-up and restored to/from a USB key. Please refer to the Basic Settings chapter.





## 5.7 \_DEFAULT PRESET

The default preset can be selected in the Startup option page of the product information menu:



Figure 38: The Info/Startup page, default preset



## 5.8 \_SET A MAXIMUM VOLUME

The maximum volume can be changed in the **Info** menu of the main page, **Setup** tab. Here, the parameter **Max. volume (dB)** will define the maximum master volume possible.

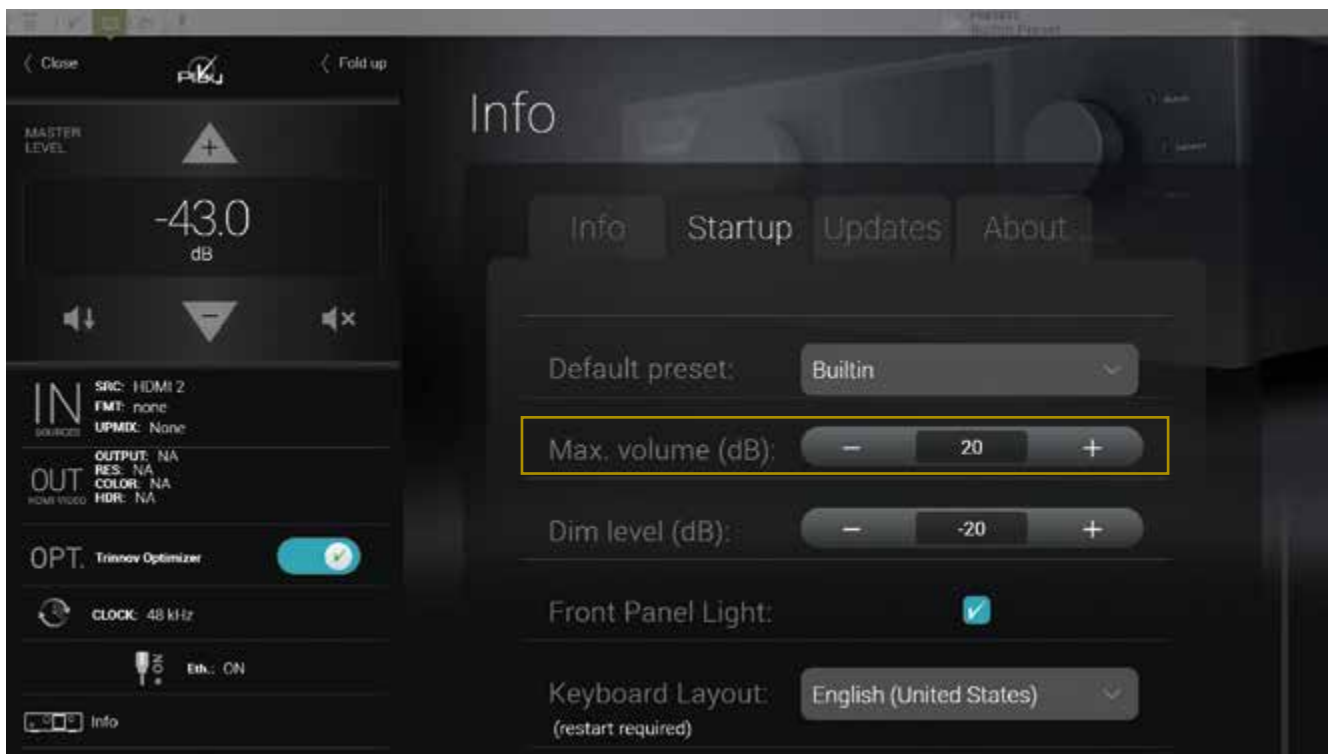

Figure 39: the Info/Startup page, maximum volume



NOTE: By default, the maximum volume possible with the Altitude<sup>32</sup> is +20dB which is extremely loud and likely to overload most consumer power amplifiers.

## 5.9 \_SET THE DIM LEVEL

By default, the Dim is applying a -20dB on the master volume. The value can be changed in the Info menu of the main page, Setup tab. Here, the parameter Dim level (dB) will define the amount of Dim to apply on the master volume when the Dim is engaged.

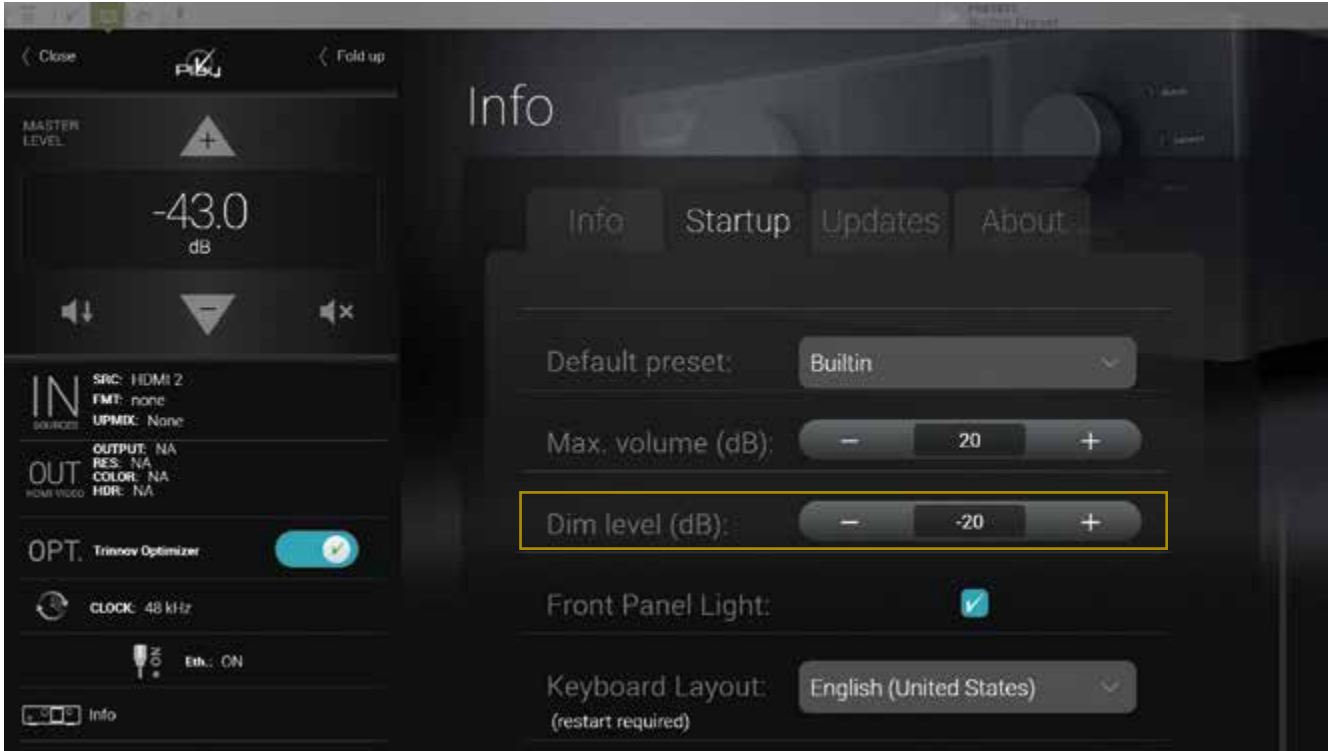

Figure 40: the Info/Startup page, Dim level

## 5.10 \_BACKUP/RESTORE CONFIGURATIONS



Figure 41: Altitude<sup>32</sup> Rear panel - USB Ports



Figure 42: USB Pop-up menu

Several parameters can be saved, archived and restored using a USB key:

1. Insert a USB key in one of the USB Ports located on the rear panel of the Altitude<sup>32</sup>.
2. As the USB Pop-up menu displays, select the operation you want to execute:
  - Save or Load presets to/from the USB Key
  - Save the target curves and PEQ to/from USB Key. They are stored in `/var/config/user_EQ/parametric_EQ`
  - Save or Load profiles (sources configurations) to/from the USB Key
  - Save or Load microphone compensation files to/from the USB Key
  - Generate and save a PDF Report for each of your presets on the USB Key. This report contains data from the Optimizer including speaker positions, optimizer settings amplitude, phase and impulse response of every speaker, before and after correction.
  - Save a Bug report to the USB Key: when an unexpected error occurred, the system is halted to prevent damage to your system and a bug report is generated. After the restart of the Altitude<sup>32</sup>, you can save that bug report on the USB Key and send it to Trinnov support at [support@trinnov.com](mailto:support@trinnov.com) for analysis.
  - Save Screenshots to the USB Key: you can take screenshots of the Altitude<sup>32</sup>'s Graphical User Interface by pressing the "print screen" key of a keyboard connected to the Altitude<sup>32</sup>.



**IMPORTANT NOTE:** to ensure the data integrity of your USB Key, please press the Close button and wait until the USB Pop-up menu has disappeared to remove it.



**NOTE:** be careful when reloading presets from a USB Key: preset are identified by their memory slot. Therefore, a preset initially saved as preset number 5 would overwrite the preset number 5 stored on the Altitude<sup>32</sup> without warning.

# 6 \_QUICK SETUP

The following section will help you calibrate your room very quickly. Indeed, Trinnov Audio has developed a step by step procedure called *Wizard* to simplify the calibration. Please follow the steps below if you want to calibrate with the Wizard or go to section.

## 6.1 \_STARTING THE WIZARD

The Wizard is a powerful tool designed by Trinnov Audio to make a precise and quick configuration of your system. The following steps are here more detailed than in the software. If you want to configure your system manually, you can go to section 10 - page 158 of the manual.



To start the Wizard click on  of the top bar menu of the main screen.



Figure 43: Starting the Wizard

You can start a new configuration with or without help. If you choose to be helped during the wizard, a pop up will show up on the right of the screen. You can close the window or enlarge it at will.

You can also continue a previous configuration that you exited or an earlier configuration

 NOTE: An old configuration that was not created with the Wizard cannot be load.

 IMPORTANT NOTE: Attention, after this step, any click on Previous will automatically set up the main screen to default configuration.

## 6.2 \_DEFINE YOUR PRESET

**!** IMPORTANT NOTE: Attention, after this step, any click on Previous will automatically set up the main screen to default configuration.

This step will allow you to save your calibration in the easiest way possible. Changes will be automatically applied to the preset that you have selected.

You can create a new preset. The Wizard invites you to enter a name for your new preset.

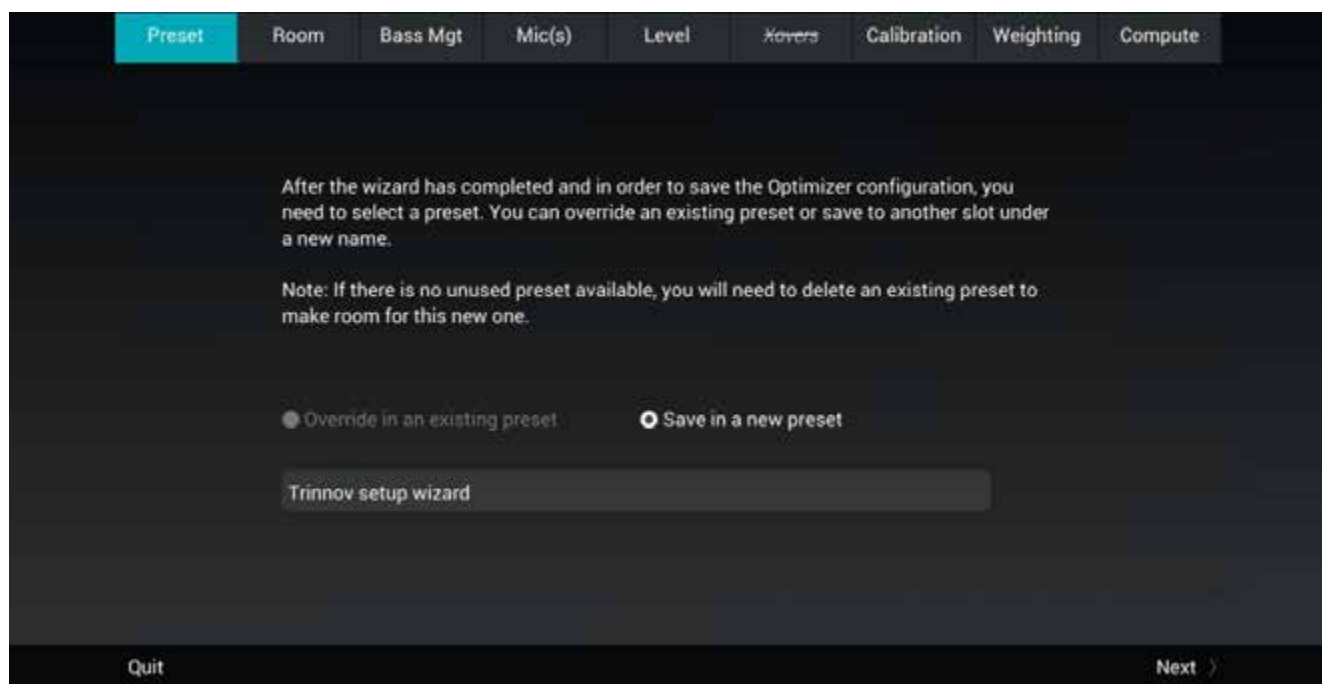

Figure 44: Select a new preset in the Wizard

If you have already reached the limit of presets number, Save in a new preset would not be available and the color of the option would turn in grey.

You can also chose to override an existing preset. Click on the arrow and select the preset you want to override.

**!** IMPORTANT NOTE: Attention, after this step, any click on Previous will automatically set up the main screen to default configuration.

Once your preset is selected, click on Next.

## 6.3 \_SETUP YOUR ROOM

In this chapter, we assume that a specific set of speakers have already been defined and installed in a room. In order to support multiple surround and 3D formats, we recommend relying on the expertise of a Certified Trinnov Installer. They can design a speaker configuration that meets your requirements and can also recommend optimal speaker placements according to your room's dimensions and acoustics.

For additional information about the Dolby, DTS and Auro-3D recommendations, please see the Appendix of this document and the related documents from Dolby, DTS and Auro.

The overall procedure to configure a speaker system is as follows:

- Select an initial speaker layout from one of the available templates;
- If necessary, Add or Remove speakers until your specific layout is defined;
- Configure the settings of each speaker, the channel mapping to Dolby, DTS, Dolby Atmos, DTS:X and Auro-3D formats and the output routing;
- Verify the routing of the speakers by playing pink noise on each speaker;
- If necessary, set some Parametric Equalizers (PEQs) on some speakers;
- Set an array of speakers (please see next chapter);
- Save the preset.

Each of these steps is described in detail in the following pages.

### 6.3.1 \_INTRODUCING THE SPEAKER/ROOM SETUP TOOL

The Altitude<sup>32</sup> provides a powerful tool to help you configure the speaker set of your home theater system. The Speaker/Room setup tool provides the following features:

- a 3D model of your room that you can rotate and zoom in/out;
- a display of the 3D speaker positions in the room;
- a comprehensive set of surround and 3D speaker layouts so you do not need to start your speaker configuration from scratch;
- add or remove speakers (satellites and subwoofers);
- detailed configuration of each speaker, the channel mapping to Dolby, DTS, Dolby Atmos, DTS:X and Auro-3D formats and the output routing;
- An easy way to set up speaker arrays;

A pink noise button to easily verify the routing of the speakers.



The Control box, located in the top right corner of the window, allows you to navigate through the 3D view. You can rotate the view, zoom in and zoom out.



**IMPORTANT NOTE:** it is important to understand that, because the Altitude<sup>32</sup>'s automated process measures all the speakers (including the subwoofers) during each measurement, you must create in the Altitude<sup>32</sup>'s user interface a speaker configuration that includes all the speakers of your installation (including the subwoofers).

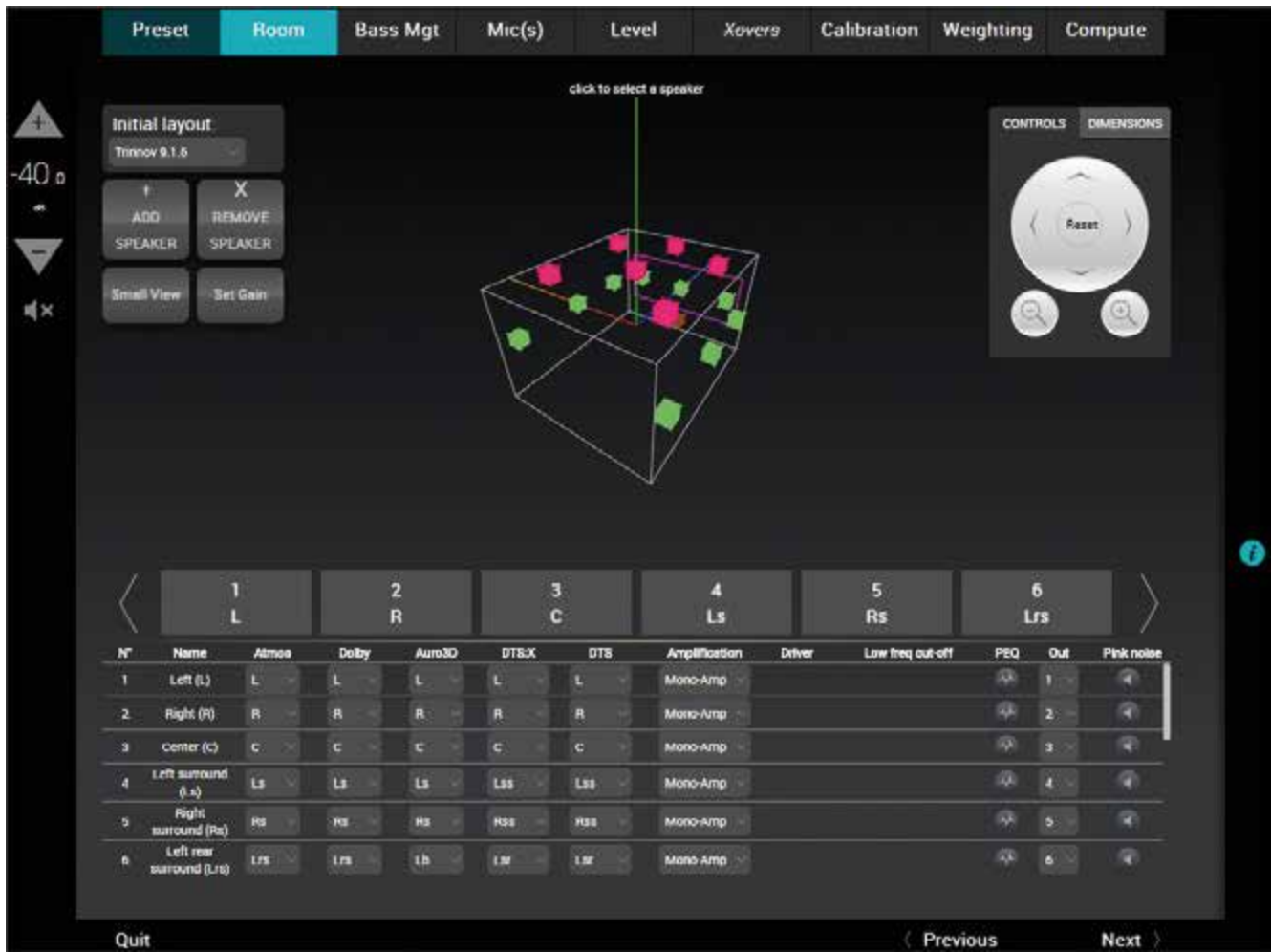

Figure 45: The Speaker/Room setup tool



The Dimensions tab allows you to set your room dimensions and screen size.

**!** NOTE: The room visualization is simply a representation showing the theoretical speaker placement of the selected layout. It is not taken into account for the acoustic optimization and does not affect the sonic performance of the system. The position of a speaker is not critical but its label will determine which decoded channel it will reproduce (when the 2D/3D speaker remapping is not engaged). (including the subwoofers).

The **Speaker Configuration** page can also be accessed through the Top Menu of the Altitude<sup>32</sup>'s graphic user interface, highlighted above.



### 6.3.2 \_AN EXAMPLE OF A SPECIFIC SPEAKER LAYOUT

The Altitude<sup>32</sup> is designed to support any speaker layout. This includes standard speaker layouts such as those specified by Dolby, DTS and Auro-3D as well as hybrid speaker layouts based on two or more speaker placement recommendations. This allows your installation to support the different surround and 3D formats currently available in DVD, Blu-ray, UHD Discs, Streaming media and file-based media.

Below is an example of a specific speaker layout designed to support multiple formats:

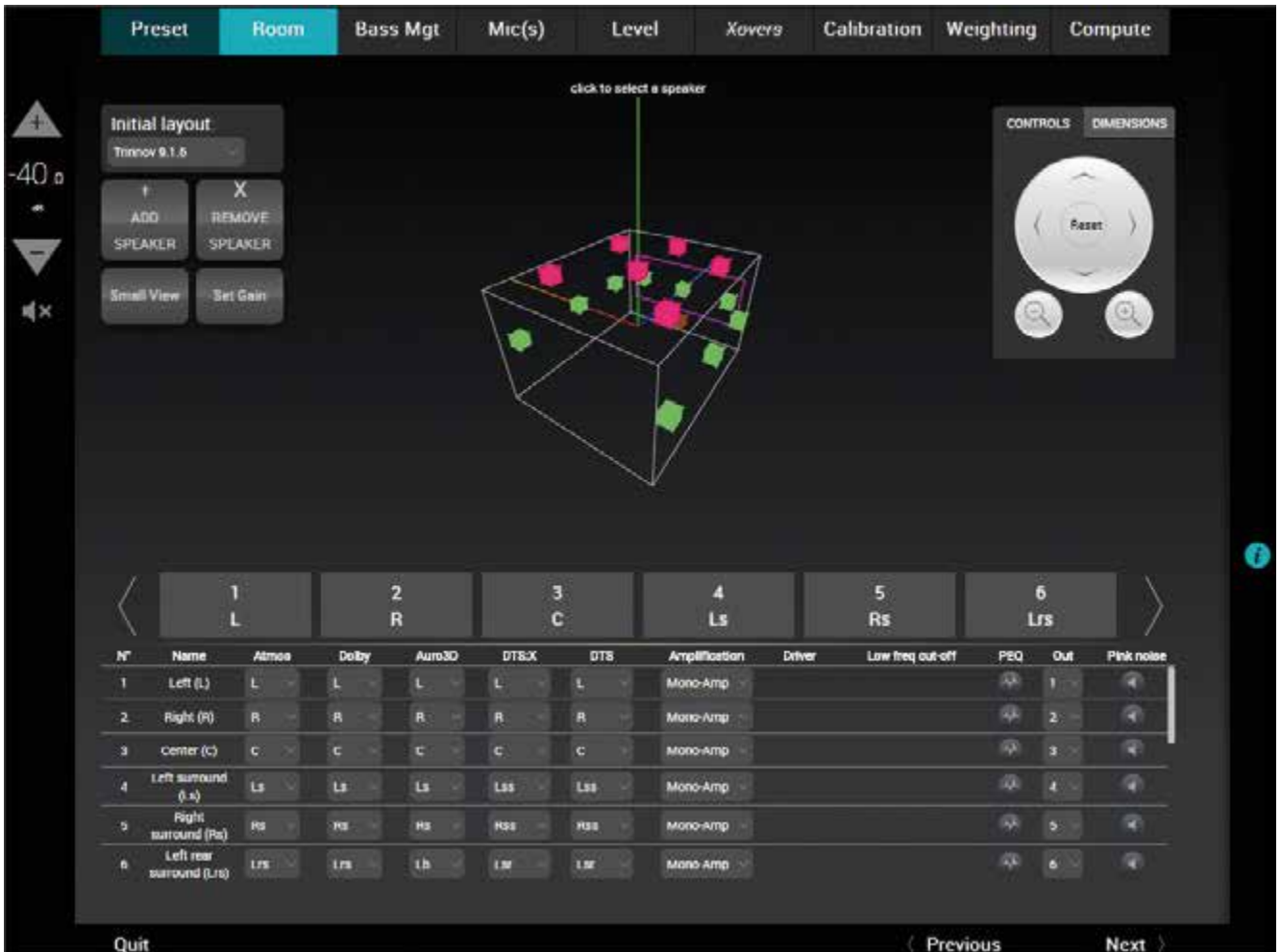

Figure 46: Example of a specific configuration with 16 speakers

This configuration of 16 speakers includes :

- 7.1 initial layout (7 full-range speakers + 1 subwoofer)
- 6 additional speakers based on the Dolby Atmos format:
  - 2 additional Lw & Rw speakers (Left wide & Right wide)
  - 4 additional height speakers: Ltf & Rtf (Left & Right top front) and Ltr & Rtr (Left & Right top rear)
- 1 additional ceiling speaker for the Auro-3D Top channel (“Voice of God”).
- 1 extra subwoofer.

The following pages describe how to setup such a configuration.

### 6.3.3 \_AVAILABLE INITIAL LAYOUTS

The following layout templates are available to start your setup process with an initial layout as similar as possible to your specific configuration.



NOTE: For detailed information about speaker recommendations, please refer to the appendix of this document and to the related Dolby, DTS and Auro-3D recommendations. The drop-down menu will only display layouts supported by the configuration (number of outputs) of the processor.

STEREO AND SURROUND LAYOUTS	DOLBY ATMOS LAYOUTS
<ul style="list-style-type: none"> <li>•Stereo 2.0 (L/R)</li> <li>•5.1 (L/R/C/LFE/Ls/Rs)</li> <li>•7.1 (L/R/C/LFE/Ls/Rs/Lrs/Rrs)</li> </ul>	<ul style="list-style-type: none"> <li>•Dolby Atmos - 5.1.2 (5.1 + Ltm/Rtm)</li> <li>•Dolby Atmos - 5.1.4 (5.1 + Ltf/Rtf + Ltr/Rtr)</li> <li>•Dolby Atmos - 7.1.2 (7.1 + Ltm/Rtm)</li> <li>•Dolby Atmos - 7.1.4 (7.1 + Ltf/Rtf + Ltr/Rtr)</li> <li>•Dolby Atmos - 9.1.2 (7.1 + Lw/Rw + Ltm/Trm)</li> <li>•Dolby Atmos - 9.1.4 (7.1 + Lw/Rw + Ltf/Rtf + Ltr/Rtr)</li> </ul>
AURO-3D LAYOUTS	DTS:X LAYOUTS
<ul style="list-style-type: none"> <li>•Auro-3D - 9.1 (5.1 + HL/HR + HLs/HRs)</li> <li>•Auro-3D - 10.1 (5.1 + HL/HR + HLs/HRs + T)</li> <li>•Auro-3D - 11.1 (5.1 + HL/HR + HC + HLs/HRs + T)</li> <li>•Auro-3D - 11.1 (7+4) (7.1 + HL/HR + HLs/HRs)</li> <li>•Auro-3D - 13.1 (7.1 + HL/HR + HC + HLs/HRs + T)</li> </ul>	<ul style="list-style-type: none"> <li>•DTS:X - 5.1.2 (5.1 + Lh/Rh)</li> <li>•DTS:X - 5.1.4 (5.1 + Lh/Rh + Lhr/Rhr)</li> <li>•DTS:X - 7.1.2 (7.1 + Lh/Rh)</li> <li>•DTS:X - 7.1.4 Heights (7.1 + Lh/Rh + Lhr/Rhr)</li> <li>•DTS:X - 7.1.4 Tops (7.1 + Ltf/Rtf + Ltr/Rtr)</li> </ul>
TRINNOV HYBRID LAYOUT	
<p>In addition to the Dolby, DTS and Auro3D templates, the Altitude<sup>32</sup> includes an hybrid layouts designed by Trinnov. This layout based on a 7.1 surround layout with additional speakers to support multiple surround and 3D formats such as Dolby Atmos, DTS:X and Auro-3D.</p> <ul style="list-style-type: none"> <li>•Note that this layout can be modified to support the largest Dolby Atmos configuration.</li> <li>•The 16 speaker layout : <ul style="list-style-type: none"> <li>• Trinnov 9.1.6 (7.1 + Lw/Rw + Ltf/Rtf + Ltr/Rtr + Hc + T)</li> <li>• 8 speakers (7 full-range speakers + 1 subwoofer) for the 7.1 surround layout</li> <li>• 6 speakers based on the Dolby Atmos format: <ul style="list-style-type: none"> <li>•2 additional surround speakers: Lw &amp; Rw (Left wide &amp; Right wide)</li> <li>•4 additional height speakers: Ltf &amp; Rtf (Left &amp; Right top front) and Ltr &amp; Rtr (Left &amp; Right top rear)</li> <li>•1 additional center height speaker for the Center Top Front channel: HC (Auro-3D ) or Ch (DTS:X)</li> <li>•1 additional ceiling speaker for the Top channel: T (Auro-3D ) or Oh (DTS:X).</li> </ul> </li> </ul> </li> <li>• The 20 speakers layout : <ul style="list-style-type: none"> <li>•Trinnov 11.1.8 (7.1 + Lw/Rw + Ltf/Rtf + Ltr/Rtr + Hc + T + Ltm/Rtm + Lc/Rc)</li> <li>•based on the Trinnov 9.1.6 layout</li> <li>•2 additional Top Middle channels : Ltm/Rtm used by Dolby Atmos and DTS:X formats</li> <li>•2 additional speakers behind the screen: Lc/Rc used by Dolby Atmos and DTS:X formats.</li> </ul> </li> <li>• The 32 speakers layout : <ul style="list-style-type: none"> <li>•Trinnov 21.1.10 (7.1 + Lw/Rw + Ltf/Rtf + Ltr/Rtr + Hc + T + Ltm/Rtm + Lc/Rc + Lsc/Rsc + Ls1/Rs1 + Ls2/Rs2 + Lrs1/Rrs1 + Lcs/Rcs)</li> <li>•based on the Trinnov 11.1.8 layout</li> <li>•2 additional speakers behind the screen : Lsc/Rsc used by the Dolby Atmos format</li> <li>•4 additional surround speakers : Ls1/Rs1 and Ls2/Rs2 used by Dolby Atmos and DTS:X formats</li> <li>•2 addition rear surround speakers Lrs1/Rrs1 used by the Dolby Atmos format</li> <li>•2 additional center surround speakers: Lcs/Rcs used by the Dolby Atmos format.</li> </ul> </li> </ul>	

### 6.3.4 \_SELECT AN INITIAL SPEAKER LAYOUT

We recommend you to start by selecting the initial layout which is most similar to your specific speaker layout.

Then, you can add/remove speakers. Alternatively, you could also create a speaker configuration from scratch.

To select an initial speaker layout:

Go to the **Speaker/Room setup** tool and click on the **Initial Layout** drop-down list

Select the layout template which is most similar to your speaker system.



Figure 47: Selecting an initial speaker layout

If your system is not in the list, you can either select a smaller system and add the missing speakers, or select a bigger system and remove the extra ones.



**IMPORTANT NOTE:** it is critical to distinguish speakers from channels because one speaker may be used to reproduce multiple channels, depending on the audio format which is being played. Therefore, your final speaker configuration on the Altitude<sup>32</sup> must include **the same number of amplification channels as in your audio system.**



**NOTE:** The **Speaker/Room setup** tool cannot display more speakers than the total number of available outputs in your Altitude<sup>32</sup> configuration. Because of that, you are limited to 16 channels. Channel assignment for each format is one of the next steps.

### 6.3.5 \_ADDING REGULAR SPEAKERS

If required, the next step is to add speakers to achieve a configuration that fits perfectly your system.

To add one or more speakers from the drop-down list:

- click on the Add Speaker button
- in the From Layout drop-down list, select the speaker template from which you want to add one or more speakers: all the speakers available in the selected speaker layout are displayed in grey color;
- in the Speaker position drop-down list, select the specific speaker you want to add to complete your layout;
- click on the Add button next to the Speaker position drop-down list;

Repeat this process for each additional speaker you want to add.



Figure 48: Selecting an initial speaker layout

To add one or more speakers from the 3D view :

- Click on the Add Speaker button;
  - in the From Layout drop-down list, select the speaker template from which you want to add one or more speakers: all the speakers available in the selected speaker layout are displayed in grey color;
  - click on the speaker you want to add: it will be displayed in yellow color;
  - click on the Add button next to the Speaker position drop-down list;
- Repeat this process for each additional speaker you want to add.

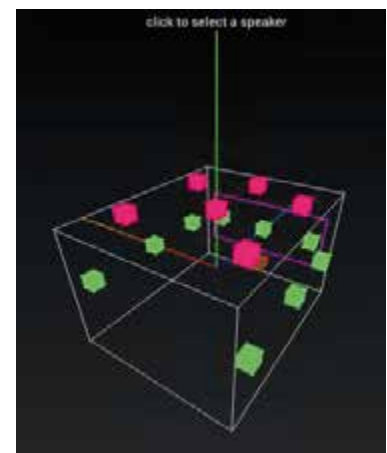
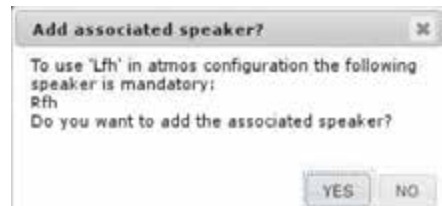

Figure 49: speaker layout representation

**!** IMPORTANT NOTE: Some configurations are not allowed by the decoders. In such cases, a red warning will be displayed on the side panel and the relevant speakers will be highlighted in red. The side panel gives you some information on the prerequisite conditions for some speakers.

**!** NOTE: If you choose to add a speaker, the Altitude32 will automatically suggest to add the mandatory associated speaker(s). This will help you to keep the integrity of the recommendations of each decoder.



To add a subwoofer:

1. Click on the Add Speaker button;
2. Click on the Add Sub button below the Speaker position drop-down list.



**!** NOTE: The Add Sub button adds subwoofers regardless of formats. The subwoofer positions displayed are not significant and will not affect the sound.

### 6.3.6 \_ADDING DOLBY ENABLED UPFIRING SPEAKERS

If your configuration has some Dolby-Enabled up-firing speakers, they will appear on the 3D view as ceiling speakers as they are used to reproduce elevation channels. In the drop-down list, those speakers end with an "e" which stands for "enabled".

Here are the available Dolby-Enabled speakers:

- Le: Left up-firing Dolby-Enabled speaker;
- Re: Right up-firing Dolby-Enabled speaker;
- Lse: Left Surround up-firing Dolby-Enabled speaker;
- Rse: Right Surround up-firing Dolby-Enabled speaker;
- Lrse: Left Rear Surround up-firing Dolby-Enabled speaker;
- Rrse: Right Rear Surround up-firing Dolby-Enabled speaker;

To add a Dolby-enabled speaker from the drop-down list, please, use the normal procedure explained above in the Adding Regular Speakers sub-chapters.

To add a Dolby-enabled speaker from the 3D view, click on one of the Dolby Top Speakers. As explained above, the Dolby enabled speakers are using the signal from Top speakers to recreate the immersion effect. The speakers concerned are

- Left and Right Top Front (Ltf/Rtf);
- Left and Right Top Middle (Ltm/Rtm);
- Left and Right Top Rear (Ltr/Rtr).

Use the procedure explained in the previous chapter to add a speaker from the 3D view. Select the speakers listed above. When clicking on Add, a dialog box will appear asking you to choose between the regular in-ceiling speaker or the associate Dolby-enabled up-firing speaker. Select the desired one.

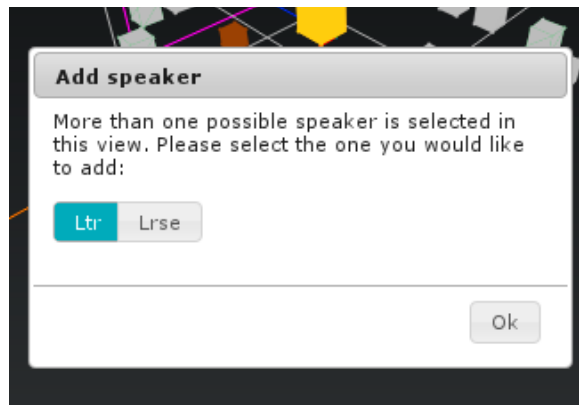

**!** IMPORTANT NOTE: The last speakers on the list are up-firing Dolby-Enabled speakers. Dolby-Enabled speakers have an included filter designed to enhance the immersion effect.

**!** NOTE: Dolby-Enabled up-firing speakers uses elevation speaker channels. In cases in which both Dolby-Enabled and ceiling speakers are used, some conflicts can occur. It will appear on the side panel.



### 6.3.7 \_REMOVING SPEAKERS

To remove one or more speakers (including subwoofers):

- Click on the speaker you want to remove. Either in the 3D representation or in the list: it will be displayed in yellow.
- Click on the **Remove speaker** button.



## 6.3.8 \_CONFIGURE THE SETTINGS OF EACH SPEAKER

Once the complete set of speakers in your system is defined, you can configure the settings of each speaker.

The speaker configuration table located in the lower part of the Speaker/Room setup tool allows you to:

- Manually map the channels of the Dolby, Dolby Atmos, DTS, DTS:X or Auro-3D formats to each speaker (optional);
- Configure the arrays of speakers for Dolby and DTS legacy format (See Speakers Arrays chapter below);
- Configure the active crossover settings (optional);
- Specify the physical output for each speaker/driver;
- Send pink noise to the assigned physical output in order to verify that the routing of each channel to each loudspeaker/driver is correct.

The **Small View** button reduces the 3D view and enlarges the speaker configuration table. Every speaker can be further configured as shown below:



Figure 50: The speaker configuration table

You can select speakers:

- by clicking on the speaker in the 3D view;
- by clicking on the corresponding channel number/name in the table's header;
- by clicking on one of the lines of the table.

The currently selected speaker is displayed in yellow in the 3D view. The available settings for each speaker are the following:

- **Dolby, Dolby Atmos, Auro3D, DTS and DTS:X channel mapping:** see above.
- **Amplification:** see above.
- **Output Channel:** specifies the physical output to be used for the speaker/driver.
- **Pink noise:** plays a -20dBFS pink noise on the specified output.

### 6.3.9 \_CONFIGURE THE CROSSOVER SETTINGS (OPTIONAL)

If you want to use the active crossovers of the Altitude<sup>32</sup>, you must use the speaker configuration table to:

Specify the type of amplification: bi-amp, tri-amp or quad-amp;

Specify the crossover frequency.

The parameters related to crossover settings are the following:

- **Amplification:** sets the number of ways of the speaker in case of multi-amplification;
- **Low freq cut-off:** sets the crossover frequencies;
- for bi-amp, it is set at 2kHz by default;
- for tri-amp, they are set at 200Hz and 2kHz by default;
- for quad-amp, they are set at 200Hz, 2kHz and 20kHz by default.

**NOTES:**

- The Altitude<sup>32</sup> handles up to 4-way active crossovers.
- The default crossover filters are Linkwitz Riley 4th order (24dB/Oct).
- Advanced crossover settings are available in the Setup/ActiveXovers page of the Advanced Settings user interface. Further information about the active-crossovers can be found in the Calibrate the Active Crossovers chapter.
- Please remember that a multi-amplification will consume a number of channels relative to the type of the multi-amplification.

### 6.3.10 \_MAPPING THE CHANNELS OF DIFFERENT FORMATS

The new Immersive Audio Formats (Auro-3D, Dolby Atmos and DTS:X) come with different channel labels and different speaker placement recommendations. This causes incompatibility issues that could make it difficult to play the required content correctly.

In the Altitude<sup>32</sup>, each speaker can be assigned to a specific channel for each format in such a way that it will play the required content regardless of the format being decoded.

In the example below, one speaker was set as the “Top” speaker recommendation of Auro Technologies to reproduce the content of the **Auro 3D Top channel** (“voice of god”). This channel also exists in DTS:X as the “Oh” channel but does not exist in the Dolby Atmos format. Therefore, this speaker will not be used during playback of native Dolby Atmos formats.



Figure 51: channel mapping example for the Top channel

In the example below, the Altitude<sup>32</sup> has automatically assigned the Left top front (Ltf) channel, initially specified as an Atmos speaker, to play the Height Left (HL) channel of Auro3D content.

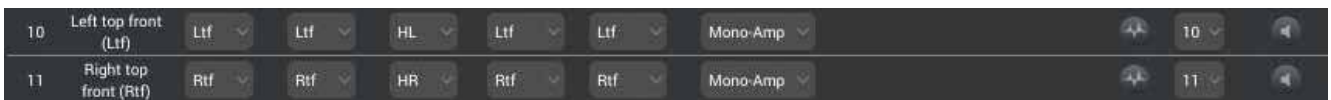

Figure 52: Channel mapping for the Left top front (Ltf) channel

**NOTE:** The channel labels and speaker positions of each format are available in the appendix of this document.

**NOTE:** To configure an array of speakers, please refer to the next chapter: Speaker Arrays

### 6.3.11 \_SENDING PINK NOISE TO VERIFY THE ROUTING OF THE SPEAKERS

As soon as the detailed configuration for each speaker is completed, it is critically important to verify that the routing of the channels to the speakers is correct and to correct any errors. Otherwise, the consistency of sound reproduction will be compromised.



**IMPORTANT NOTE:** This procedure only helps to verify that the routing is correct from the Altitude<sup>32</sup> to the speakers. In addition to this procedure, when a new source is connected to the Altitude<sup>32</sup>, you should also verify that the routing is correct from the source to the Altitude<sup>32</sup>.

To verify the routing of each speaker:

- Select the speaker by clicking in the 3D view or by selecting the corresponding line in the speaker table;
- Click on the Pink Noise icon;
- Locate the speaker through which the pink noise is being played;
- Verify that the playing speaker matches the selected channel in the Altitude<sup>32</sup>'s Speaker/Room setup tool;
- If there is no match, fix the routing of the speaker by modifying the assigned Output.

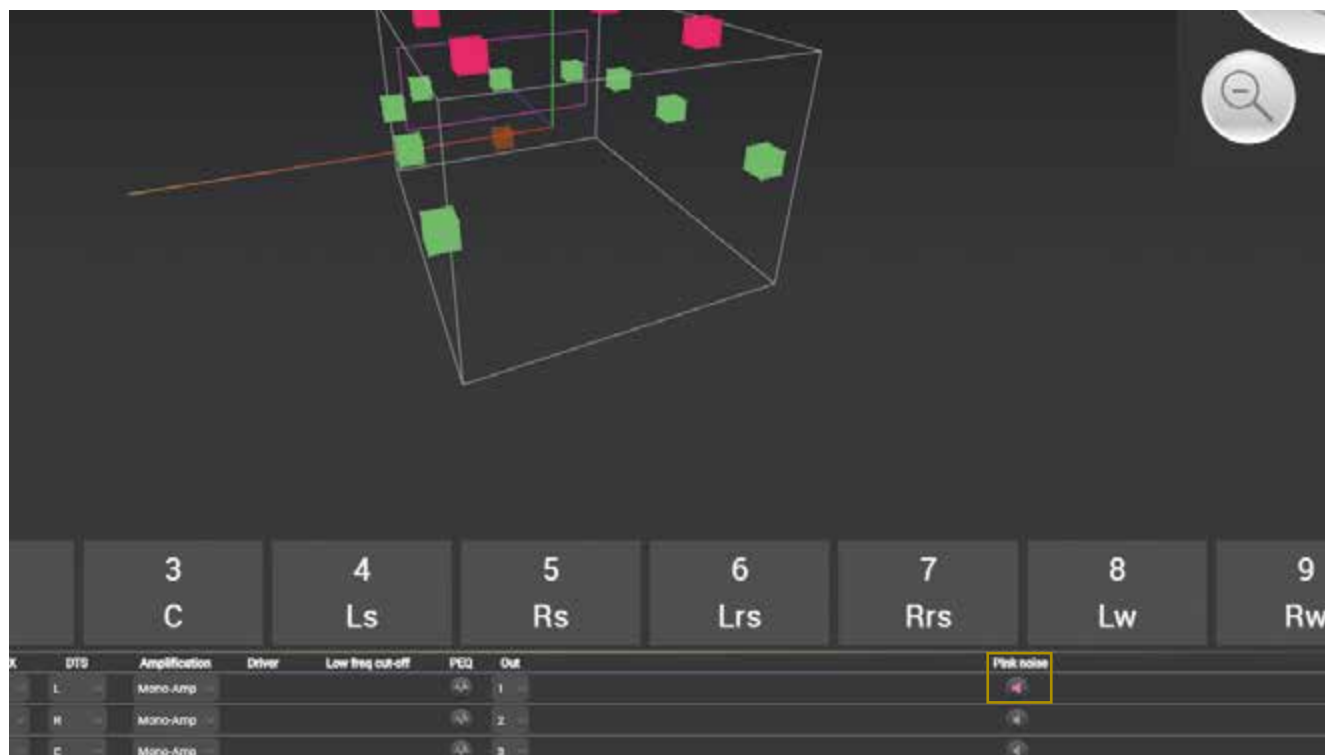

*Figure 53: sending pink noise to the speakers*



**IMPORTANT NOTE:** The Altitude<sup>32</sup> needs to be synchronized on an audio clock, either external (Slave mode) or internal (Master mode) in order to produce the pink noise. If a Digital source is selected with no signal, the pink noise won't be produced. In such case, we simply recommend selecting an analog source.



### 6.3.12 \_ADD A PARAMETRIC EQUALIZER

A Parametric Equalizer (PEQ) is an equalization done by setting parameters, mostly 3: frequency, gain and Q.

There are 3 types of PEQ available:

- The peak notch: Parametric equalizers are multi-band variable equalizers which allow users to control the three primary parameters: amplitude (gain), center frequency and bandwidth (Q).
- The shelving high (1st or 2nd order): Shelving high filters cut or boost all frequencies equally above a desired cutoff point.
- The shelving low (1st or 2nd order): Low shelving filters cut or boost all frequencies equally below the desired cutoff point.

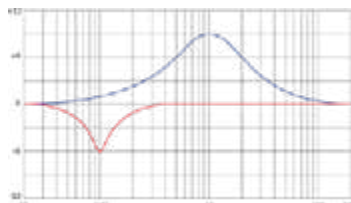

Figure 54 Peak notch: with positive gain (blue) and negative gain (red):  
The red one has a higher Q (the higher the Q, the narrower the bandwidth impacted)

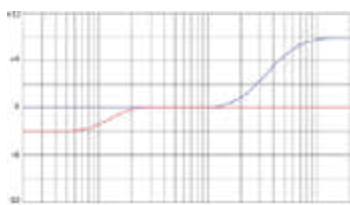

Figure 55: Shelving: high in blue (1st order), low in red (2nd order)

Each parametric equalization band will have the following settings:

- Frequency: the center of the frequency range to be cut or boosted
- Gain: the amount of boost or cut
- Q: the «sharpness» of the boost or cut, with higher Q meaning a narrower filter (not available for shelving second order)
- Order (Only available for High and Low shelving filters): The order of a shelving filter is changing the shape of the curve.

All of these settings are saved with the preset.

The PEQ editor is accessible from the 3D view of the speaker layout editor. One editor is available for each output which means that, in case of active multi-amplification, one PEQ editor is available for each driver of the speaker.

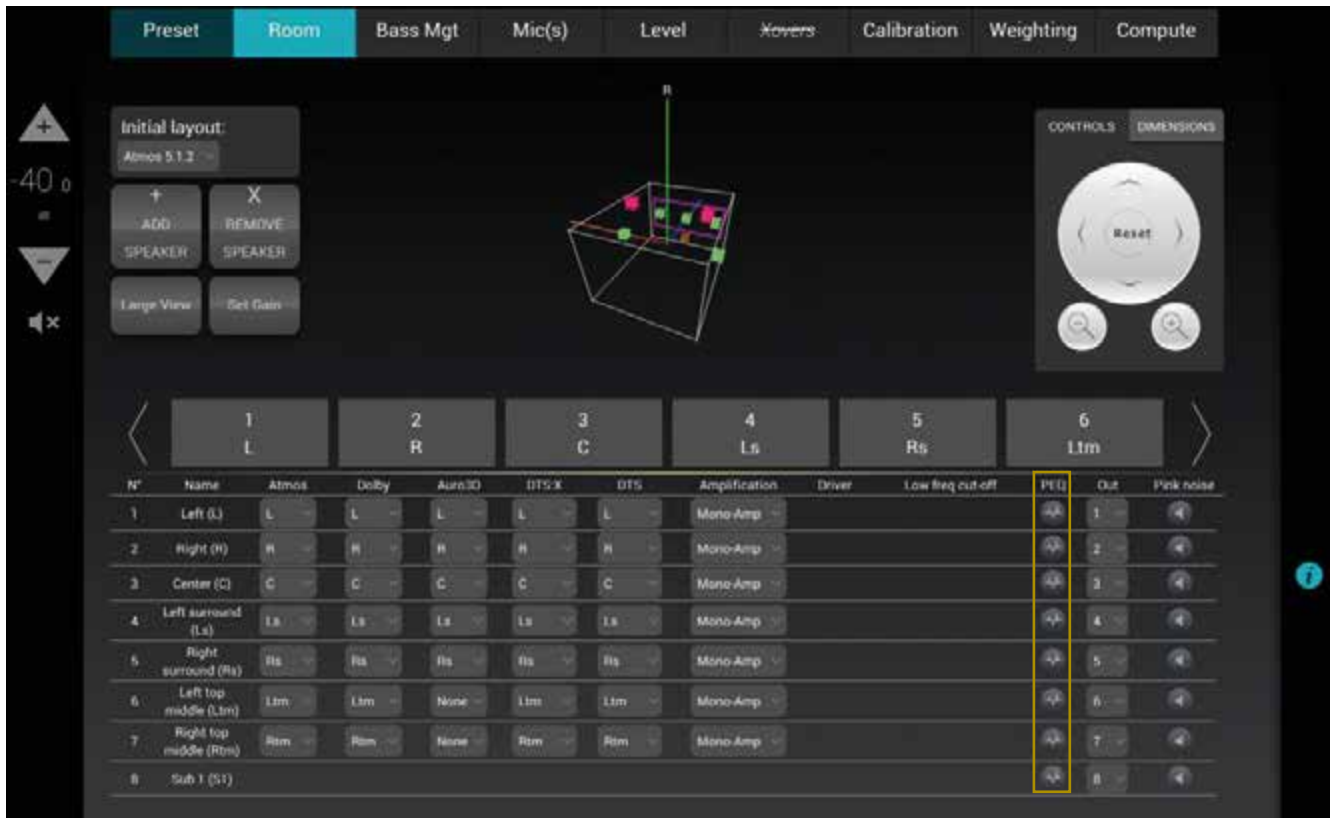

To open the PEQ editor, click on the PEQ icon  of the speaker or driver you want to edit. The PEQ editor will be displayed as a pop-up which overlay the 3D view, as followed:

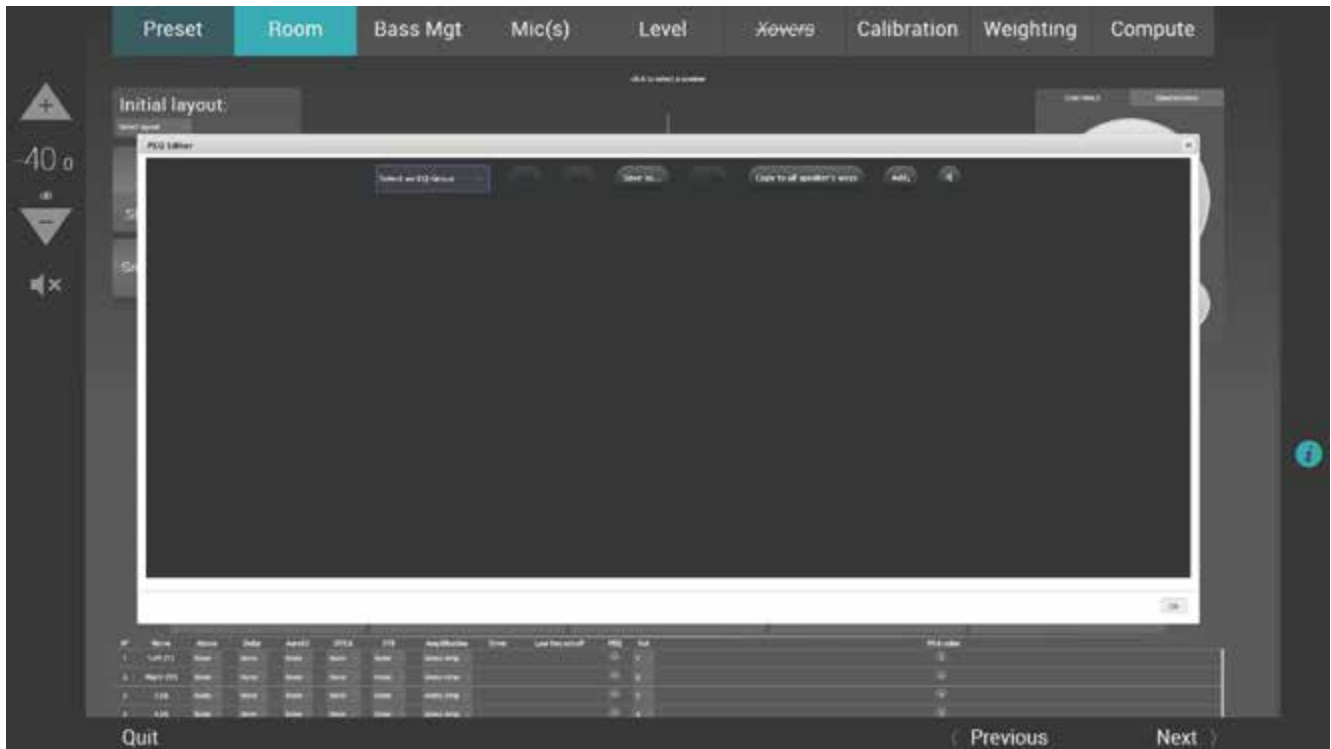

### \_6.3.12.1 \_ADD A PEQ

To add a PEQ, click on the Add button. A new line will appear in the table. This line is a Parametric Equalizer band. You can add as many bands as required per channel.

The overall procedure to configure a PEQ is as shown below:

- Open the PEQ editor of the speaker (or driver) you want to edit;
- Add as many bands as needed using the Add;
- Set the parameters of each band as wanted or as needed by the speaker manufacturer. The parameters are explained below;
- Eventually control the result with the pink noise using the button ;
- If needed, save the settings as an EQ group, this makes easier to duplicate a setting on several speakers (procedure explained later in this chapter);
- Close the PEQ editor with the Ok button at the bottom of the page.

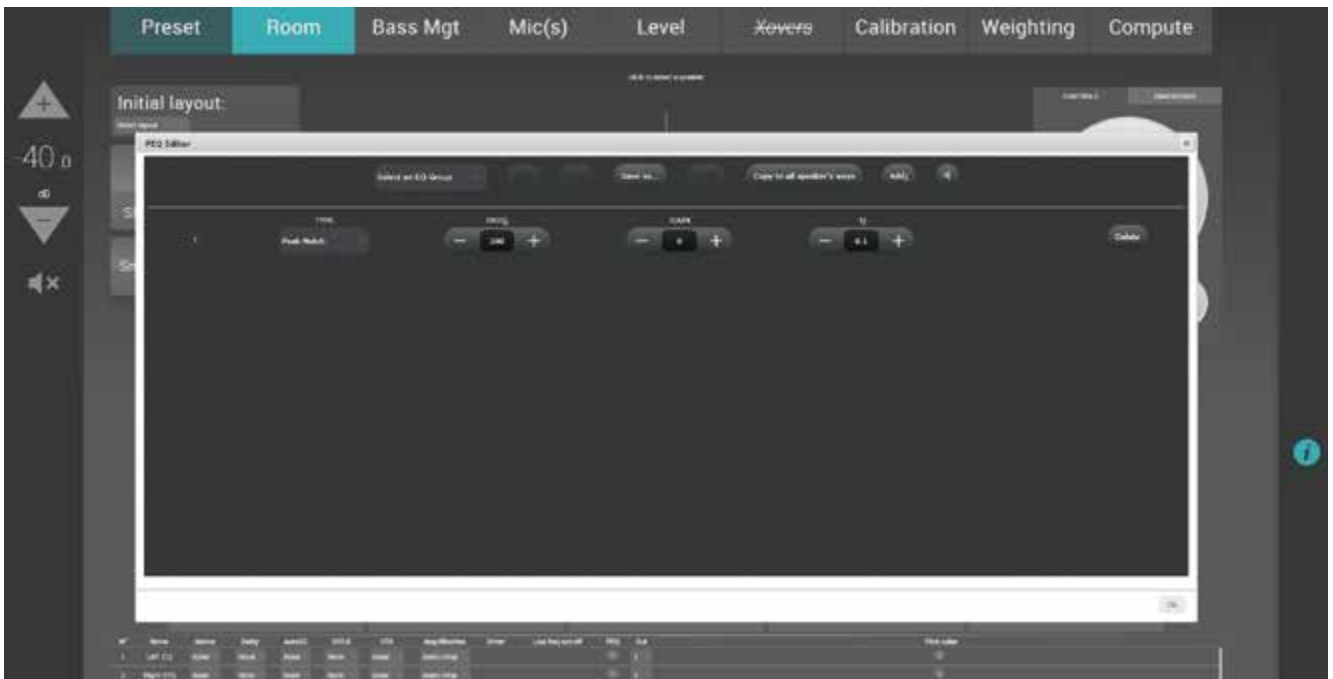

Each PEQ band has the following parameters:

- Filter Type:
  - The peak notch: Parametric equalizers are multi-band variable equalizers which allow users to control the three primary parameters: amplitude, center frequency and bandwidth.
  - The shelving high (1st or 2nd order): High shelving filters cut or boost all frequencies equally above a desired cutoff point.
  - The shelving low (1st or 2nd order): Low shelving filters cut or boost all frequencies equally below a desired cutoff point.
- Frequency: the center of the frequency range to be cut or boosted
- Gain: the amount of boost or cut (in dB)
- Q: the «sharpness» of the boost or cut. Higher Q meaning a narrower filter (not available for shelving second order)
- Order (Only available for High and Low shelving filters): The order of a shelving filter is changing the shape of the curve.

The PEQs are saved in a presets.

### \_6.3.12.2 \_DELETE A PEQ



To delete a PEQ band, please click on the Delete button at the end of the line. Delete a band is a definitive action that cannot be undone.

### \_6.3.12.3 \_SAVE A NEW PEQ GROUP

In the case of several similar speakers needing to have the same PEQ settings applied, it is possible to save a PEQ group to have the possibility to load on another channel.

Once the PEQ has been fully edited, to save it as a new PEQ Group, click on the **Save as...** button;



A virtual keyboard will appear. Please give a significant name;



Once it is done, click on the green validate button;



You are now back to the PEQ Editor. This means that the EQ Group has been saved. It is available in the **Select and EQ Group** drop-down list. To load it, check the next chapter Load a PEQ Group.



### \_6.3.12.4 \_LOAD A PEQ GROUP

Once an EQ group has been saved, it is possible to load it on another channel. Here is the procedure:

Open the PEQ editor for the channel of interest. The saved EQ group are available in the drop-down menu of the top left corner called Select an EQ Group;



Select the EQ group you would like to load in the drop-down list;



Once the desired EQ group is selected, please click on the Load button;



The EQ group is now loaded on this channel. Repeat the procedure on another channel if needed. Close the PEQ editor by clicking on OK.



### \_6.3.12.5 \_DELETE A PEQ GROUP

If an EQ group is not useful anymore, it is possible to delete it to keep a clean and effective list of EQ group. To do so, please follow this procedure:

Open any PEQ editor. The saved EQ group is available in the drop-down menu of the top left corner called **Select an EQ Group**;



Select the EQ group you would like to delete in the drop-down list;



Once the desired EQ group is selected, please click on the **Delete** button;



The EQ group is now deleted. Repeat the procedure on other EQ Group if needed. Close the PEQ editor by clicking on the **Ok** button.



\_6.3.12.6 \_SAVE A PEQ GROUP ON AN EXISTING ONE

\_IF AN EXISTING EQ GROUP NEEDS MODIFICATION, IT IS POSSIBLE TO OVERWRITE IT WITH THE NEW PARAMETERS. TO DO SO, PLEASE FOLLOW THIS PROCEDURE:

Once you are sure the modifications are fine, you can now overwrite this group of EQ on an existing one. The saved EQ group are available in the drop-down menu of the top left corner called Select an EQ Group;



Use the drop-down menu to select the group of EQ to overwrite;



Use the Save button to overwrite the selected EQ group. It means that the current state of the PEQs will be saved on the selected EQ group. The previous save will be erased;



The EQ group is updated. Close the PEQ editor by clicking on the Ok button.



### \_6.3.12.7 \_GENERATE PINK NOISE

The PEQ Editor has its own quick access to the pink generator. Click on the speaker button to generate pink noise on the selected speaker. Please note that in case of multiway speakers, the pink noise will be generated on the whole speaker.



### 6.4.13 \_SETTING UP AN ARRAY OF SPEAKERS

With the release of new 3D audio formats, the number of possible speaker positions increases considerably. Nevertheless, your video library is surely full of "surround" content (5.1 or 7.1). Furthermore, 3D formats do not all have the same limitation in terms of simultaneous active speakers.

So, it becomes essential to be able to create an array of speakers: use several speakers to play the same channel. It is also possible to adjust the gain of each speaker of the array to perfectly match the needs of the Home-Theater; Thereby, the immersion effect is much more impressive!

Similar configurations have been used in commercial cinemas for years.

Once your speaker layout has been declared, configured and fully tested, you can now set up your arrays of speakers. The Altitude<sup>32</sup> is able to duplicate the incoming channel from the decoders on several speakers.

The setup of an array has to be done within the Speaker/Room setup tool using the mapping column of each decoder. As explained in the previous chapter *Specify a speaker layout* and *Mapping the channels of a different format*, each format has its own speaker assignation. You can easily control the number of speakers used by each decoder. Each column defines the channel used by the associated speaker. In this way, you are able to select the same channel on several speakers.

N°	Name	Atmos	Dolby	Auro3D	DTS:X	DTS	Amplification	Driver	Low freq cut-off
1	Left (L)	L	L	L	L	L	Mono-Amp		
2	Right (R)	R	R	R	R	R	Mono-Amp		

In the **Speaker/Room setup** tool, you can observe five columns giving the details of each decoder's layout:

- **Atmos:** Layout used for native Dolby Atmos content and Dolby Surround Upmixer;
- **Dolby:** Layout used for Legacy Dolby content;
- **Auro-3D:** Layout used for Native Auro-3D content and Auro-3D Upmixer;
- **DTS:X:** Layout used for native DTS:X content and Neural:X Upmixer;
- **DTS:** Layout used for Legacy DTS content.

To specify a speaker layout, please select, in the drop down menu of each speaker, the desired channel that it has to play for each decoder.



**IMPORTANT NOTE:** DTS:X is limited to 11 different channels. Nevertheless, you can use the arrays to duplicate these 11 channels and use more than 11 speakers.



### \_6.3.13.1 \_EXAMPLE OF AN ARRAY OF SPEAKERS

Below is an example of a specific speaker layout designed to array some channels:

		1 L	2 R	3 C	4 Ls	5 Rs	6 Lrs					
N°	Name	Atmos	Dolby	Auro3D	DTS:X	DTS	Amplification	Driver	Low freq cut-off	PEQ	Out	Pink noise
1	Left (L)	L	L	L	L	L	Mono-Amp				1	
2	Right (R)	R	R	R	R	R	Mono-Amp				2	
3	Center (C)	C	C	C	C	C	Mono-Amp				3	
4	Left surround (Ls)	Ls	Ls	Ls	Lss	Lss	Mono-Amp				4	
5	Right surround (Rs)	Rs	Rs	Rs	Rss	Rss	Mono-Amp				5	
6	Left rear surround (Lrs)	Lrs	Lrs	Lb	Lsr	Lsr	Mono-Amp				6	
7	Right rear surround (Rrs)	Rrs	Rrs	Rb	Rsr	Rsr	Mono-Amp				7	
8	Left wide (Lw)	Lw	Lw	Ls	Ls	Ls	Mono-Amp				8	
9	Right wide (Rw)	Rw	Rw	Rs	Rs	Rs	Mono-Amp				9	
10	Left top front (Ltf)	Ltf	Ltf	HL	Ltf	Ltf	Mono-Amp				10	
11	Right top front (Rtf)	Rtf	Rtf	HR	Rtf	Rtf	Mono-Amp				11	
12	Left top rear (Ltr)	Ltr	Ltr	HLs	Ltr	Ltr	Mono-Amp				12	
13	Right top rear (Rtr)	Rtr	Rtr	HRs	Rtr	Rtr	Mono-Amp				13	
14	Center top front (Ctf)	None	None	HC	None	None	Mono-Amp				14	

In the example above, please pay attention to Left Wide and Right Wide speakers:

- For Dolby Atmos content, Left and Right Wide speakers will play natively as they natively exist in the codec; For Dolby Legacy content, Left and Right Wide speakers will play Ls and Rs channel, simultaneously with Left and Right surround speakers;
- For Auro 3D content, Lw and Rw do not exist natively. In this configuration Left and Right Wide speakers will play Ls and Rs channels simultaneously with Left and Right Surround speakers;
- For DTS:X content, Left and Right Wide speakers will play Lss and Rss channel simultaneously with Left and Right surround speakers;
- For DTS Legacy content, they will play Lss and Rss channel simultaneously with Left and Right surround speakers;

### \_6.3.13.2 \_ADJUST THE GAIN

As you decide to array some speakers, it may be needed to adjust the gain of each speaker accordingly to each decoder. It is possible to do it speaker by speaker, or to select a group of speakers to apply the same gain adjustment.



To access the speaker's gain control panel, click on *Set Gain* in the Speaker/Room setup tool. Instead of the channel assignation, the gain control will be displayed.

The screen below displays the **Set Gain** control panel. Each channel assigned from each speaker has a value (default: 0) surrounded by – and + buttons. Use these buttons to adjust the gain in 1dB increments.

By clicking on a value, you also can manually enter a gain. In this case, a virtual numerical keyboard is displayed;



Figure 56: Set gain control panel

The Selected  Selected speakers can all be modified simultaneously using the control panel in the top left corner.

You can add or decrease gain using **-1dB** or **+1dB** button, or by using the **Direct input** and its numerical keyboard.

The **Reset** button clears any modification and sets the default value of 0dB.

The **Clear selection** unselects every speaker, keeping the modified values.

**!** IMPORTANT NOTE: High gain values can damage a speaker.

## 6.4 \_SETUP BASS MANAGEMENT

This chapter explains how to setup bass management in the Altitude<sup>32</sup>.

The Altitude<sup>32</sup> provides very flexible options that help you to optimally configure the bass management of your system. You can specify how the lower frequencies of each channel will be reproduced by one or more subwoofers. Additionally, the revolutionary intermediary bass management allows you to redirect the low frequencies of a small speaker (i.e. ceiling speaker) to the closest bigger speaker. This will help to relieve small speakers while keeping the localization of the channels as accurate as possible.

In other words, individual speakers can be bass-managed with any combination of subwoofers or bigger speaker with any specific crossover frequencies, filter type and slope.

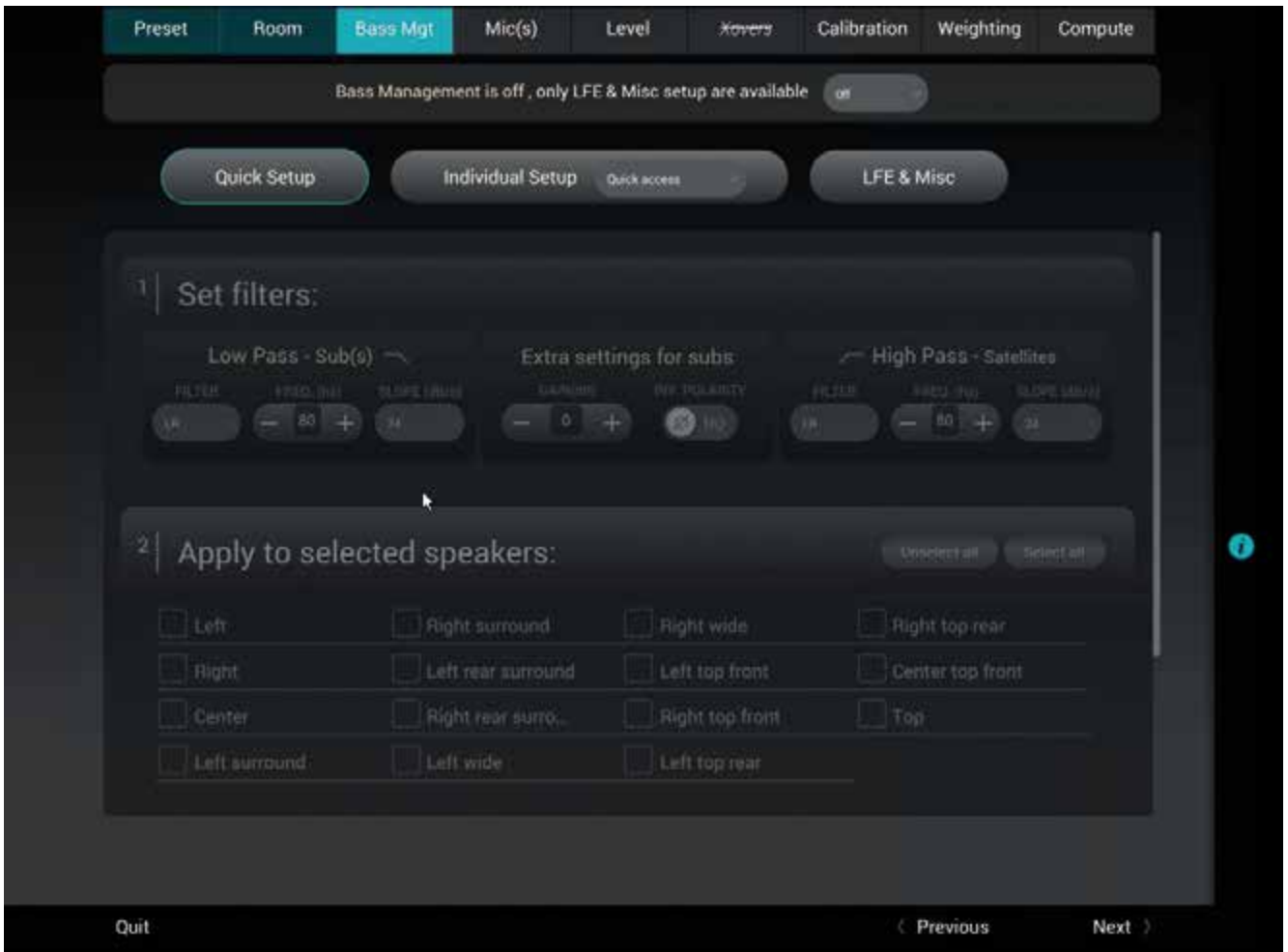

Figure 57: Bass Management step in the Wizard



**NOTE:**

- The Altitude<sup>32</sup> supports any number of subwoofers as long as enough physical outputs and processing channels are available, therefore allowing a maximum flexibility in the speaker system design.
- Bass Management can be activated even if the system has not been calibrated. However, the automatic time-alignment of the subwoofers is only performed after a calibration of the whole set of speakers



**IMPORTANT NOTE:**

- For optimal results, the bass management should be setup manually based on the acoustic measurements of the speaker responses in the room.
- The Optimizer graphs show what each speaker is capable of doing, which can inform your bass management decisions.

## 6.4.1 \_OVERVIEW OF THE BASS MANAGEMENT SETUP PROCEDURE

**The recommended bass management setup procedure is as follows:**

- Analyze the acoustical graphs of the speaker measurements in order to understand the low frequency response of each speaker in the room;
- Decide whether bass management is necessary or not;
- To decide to activate bass management:
  - Identify the High Pass Frequency that seems appropriate for each channel;
  - Configure the bass management options (Off, On, On + Lfe to lr (Legacy));
  - Configure each channel to have its lowest frequencies redirected to one or more subwoofers.
  - Configure each channel to have its lowest frequencies redirected to one or more bigger speakers.
- Last but not least: Save the preset.

- The Bass management is divided into 3 different sections represented as 3 tabs which will be detailed in the following chapter:
  - **Quick Setup:** The Quick Setup is the default section of the Bass Management. It allows a global configuration by applying values on several speakers and subwoofers simultaneously (It is not enabled if Bass-Management is Off);
  - **Individual Setup:** The Individual Setup provides the ability to adjust the settings on each speaker and sub individually (It is not enabled if Bass-Management is Off);
  - **LFE & Misc:** This allows adjustment of the LFE gain, polarity, Low-pass filter type, Low-pass frequency, slope, as well as enabling the standard +10dB LFE input and stacked sub correction.

The Bass Management page is also accessible through the Top Menu of the Altitude<sup>32</sup> User Interface.

The Altitude<sup>32</sup> allows you to specify how the lower frequencies of each channel will be reproduced by one or more subwoofers or speakers. For each speaker you can:

- Specify High Pass and Low Pass filters for the speakers and the bass-managed signal redirected to the subwoofer(s) or speaker(s) (including frequency, filter type and slope);
- Activate one or more subwoofers or speakers that will reproduce lower frequencies from that channel;
- Setup the gain and polarity for each bass-managed signal redirected to one or more subwoofer(s) or speaker(s);
- Setup the gain for each subwoofer;
- Invert the polarity for each subwoofer;
- Route the LFE channel to one or more subwoofer(s) or speaker(s).

This is different from the majority of the currently available AV surround preamplifiers which offer relatively simple bass management features. They usually allow you to choose from only two types of speakers: “large” or “small”, and have predefined parameters for the bass management filters.

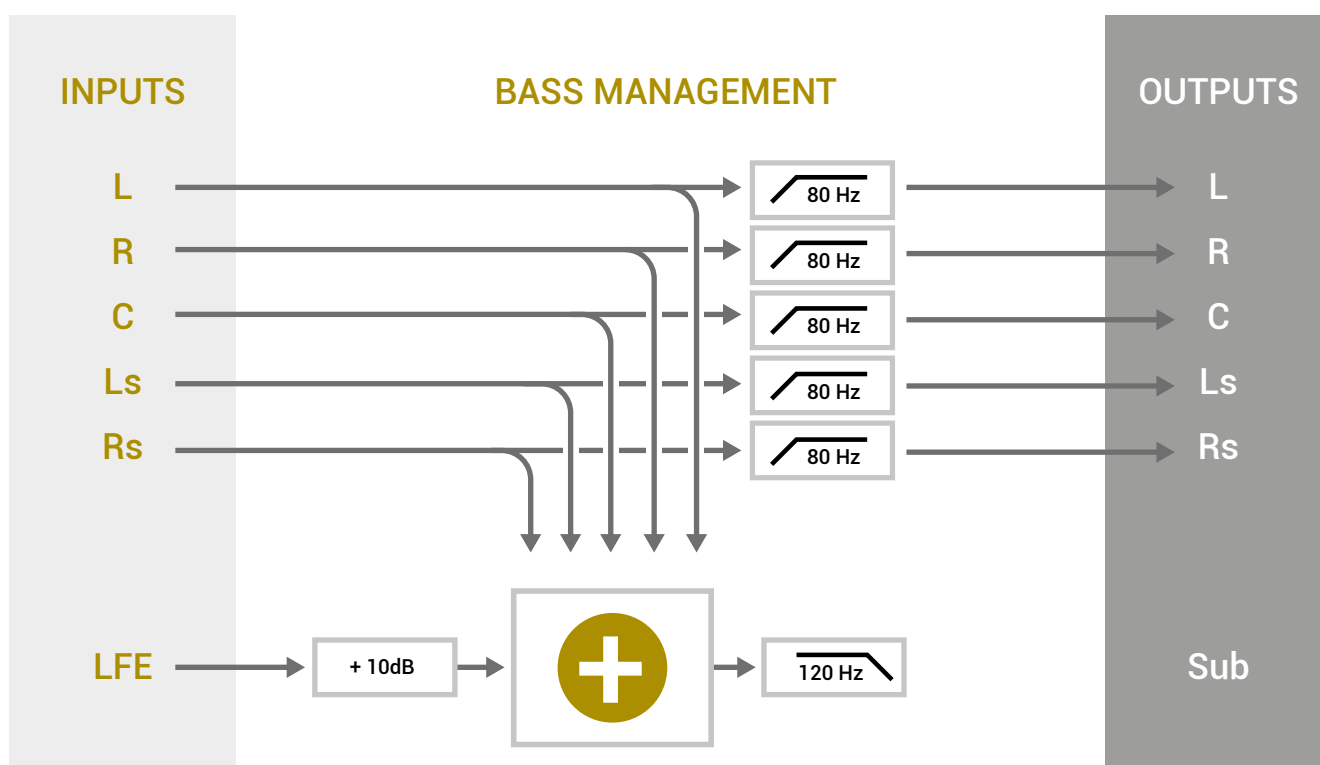

Figure 58: Typical bass management in a standard surround preamplifier

## 6.4.2 \_BASS MANAGEMENT MODE

The Altitude<sup>32</sup> offers 3 different bass management modes:

- Off: No bass management (default);
- On: Standard bass management mode + intermediate bass-management mode;
- On + LFE to LR (legacy): Distributes the LFE signal only to the Left and Right speakers. Can be used when there is no subwoofer in the system. Note that in this mode, if a subwoofer is declared, the LFE will not be played by this subwoofer.

Those modes are accessible from the dropdown menu as shown below:

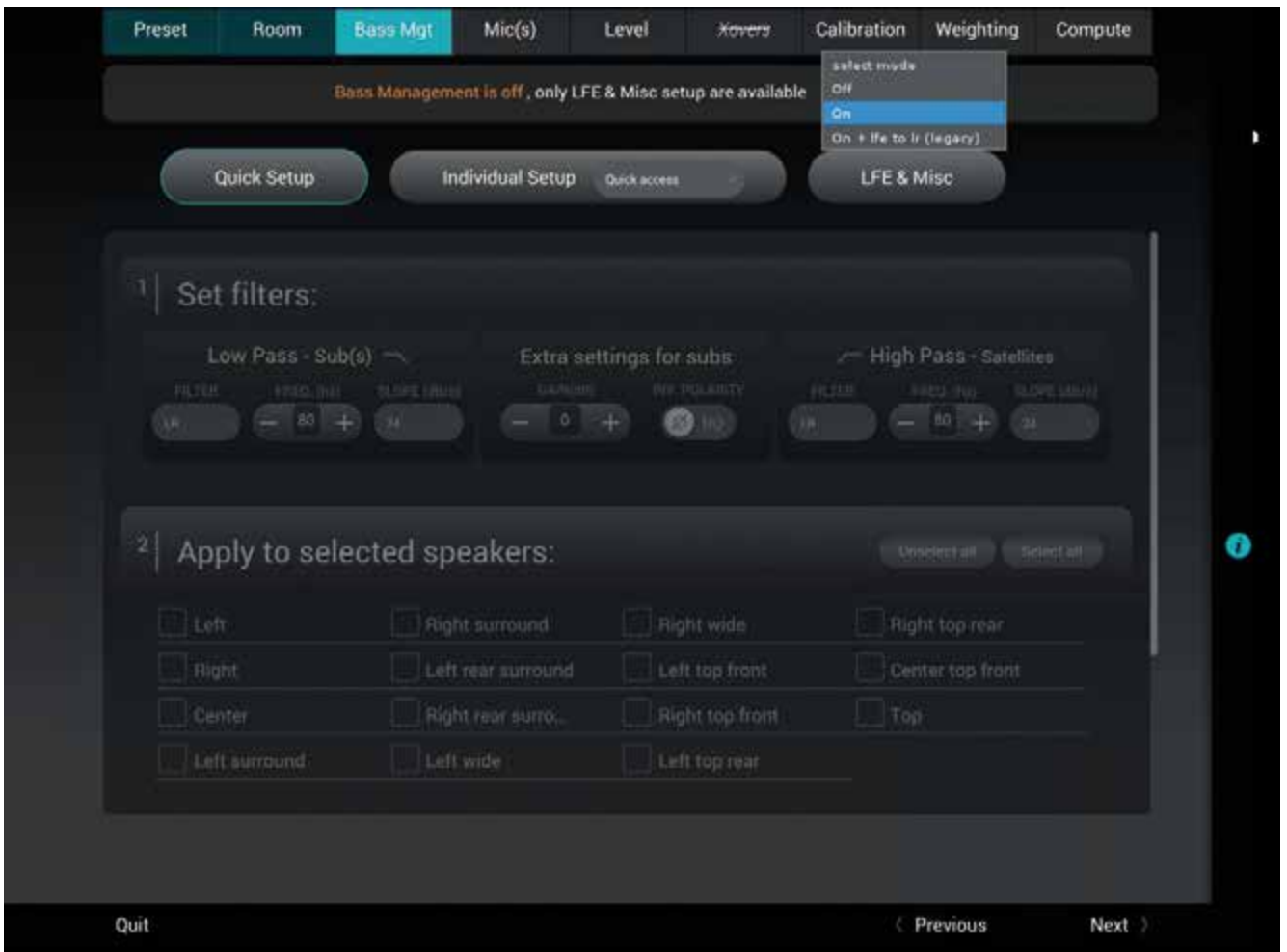

Figure 58: Access to the Bass-Management options



### 6.4.3 \_QUICK SETUP MENU

The Quick Setup menu is a powerful tool allowing to configure the bass management for several speakers in one manipulation.

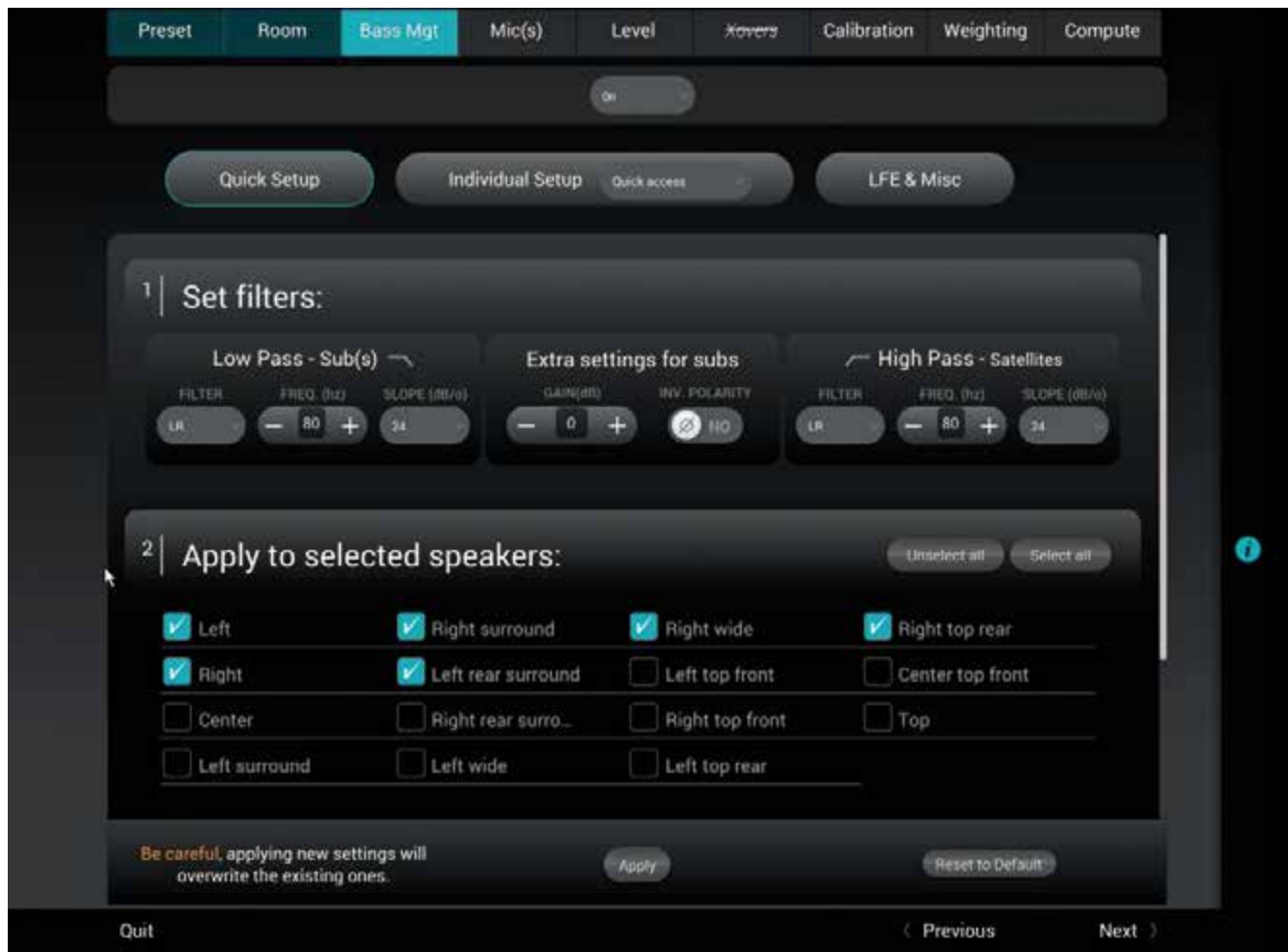

Figure 59: Bass-Management Quick Setup

The Quick Setup menu is divided into 3 main sections:

1. **Set Filters:** This section is to specify the filter type and frequencies that will be applied;
2. **Apply to selected speakers:** Here, you can choose the speakers on which you can apply the filters selected in the first section;
3. **And apply the associated sub(s):** Select the sub(s) associated with the group of speakers and filters. The 3 sections are detailed in the sub-chapters below.

The configuration steps are the followings:

- Enter the desired settings in the 1| Set filters table;
- Select the speakers on which you want to apply those settings on the 2| Apply to selected speakers section;
- ... and the associated sub(s) in the And apply to associated sub(s) section;
- Press on the Apply button to validate;
- Do the same manipulation for another group of speakers and sub if needed;
- Listen and adjust if required;
- Save the preset.

**!** NOTE: It is not possible to apply the settings if no subs are selected. This means that you cannot disable bass management on several speakers at the same time with the Quick Setup menu. To do so, please use the Individual Setup described in the next sub-chapter.

### \_6.4.3.1 \_SET FILTERS

As shown below, this first section is divided in 3 different groups of settings:

- **Low Pass – Sub(s):** These settings will determine the cutoff frequency below which the signal from the channel will be re-directed and played by the subwoofer(s). You can here select the type of filter (Linkwitz-Riley, Bessel or Butterworth), the cutoff frequency and the slope used by this filter. These settings are only applied to the signal redirected to the subwoofer(s).
- **Extra settings for sub(s):** These additional settings give the possibility to invert the polarity and adjust the gain of the signal redirected to the subwoofer(s). These settings are only applied to the signal redirected to the subwoofer(s).
- **High Pass – Satellites:** This section will determine the low-end cutoff frequency of the signal sent to the satellites. You can here select the type of filter (Linkwitz-Riley, Bessel or Butterworth), the cutoff frequency and the slope used by this filter. These settings are applied to the signal directed to the Satellites.

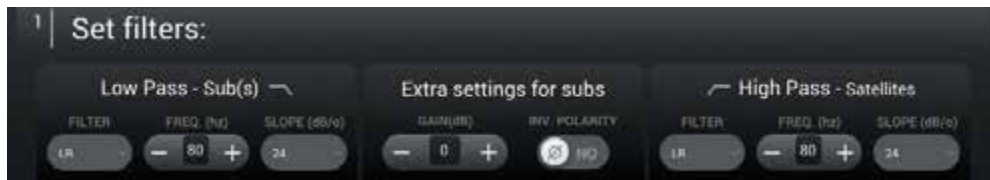

### \_6.4.3.2 \_APPLY TO SELECTED SPEAKERS

The second section is here to define the group of speakers on which the filters will be applied. The speakers, or satellites, are only concerned by the High Pass filter. The speaker selection is done by checking the box on the left side of each speaker's name.

Two buttons are in the Top right corner of this second section:

- Unselect all: Clicking on this button unselects every speaker;
- Select all: Clicking on this speaker selects every speaker.

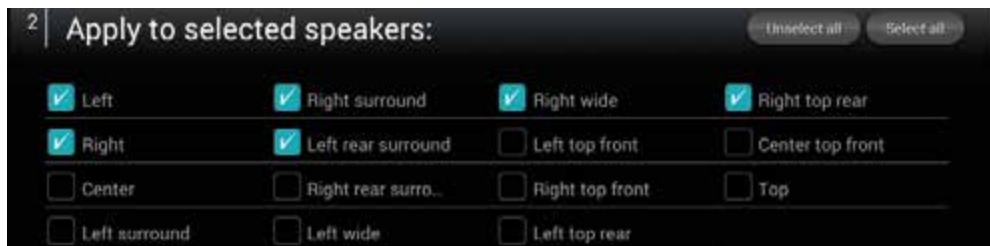

## 6.4.4 \_INDIVIDUAL SETUP MENU

### \_6.4.4.1 \_REGULAR BASS MANAGEMENT

The settings provided are similar to the Quick Setup menu but are adjustable on each speaker individually. Each speaker has the following parameters:

- The activation of each sub by checking the **Active** box (which recalculates the attenuation accordingly): The bass-managed signal will be redirected to the selected subwoofer(s);
- **Gain and Polarity:** These additional settings provide the option to invert the polarity and adjust the gain of the signal redirected to the subwoofer(s). These settings are only applied to the signal redirected to the subwoofer(s), the signal going to the speaker remains unchanged;
- **Low Pass – Sub(s):** These settings will delimit the cutoff frequency below which the signal from the channel will be re-directed and played by the subwoofer(s). You can select the type of filter (Linkwitz-Riley, Bessel or Butterworth), the cutoff frequency and the slope used by this filter. These settings are only applied to the signal redirected to the subwoofer(s);

**High Pass – Satellites:** This section will delimit the low-end cutoff frequency of the signal sent to the satellites. You can here select the type of filter (Linkwitz-Riley, Bessel or Butterworth), the cutoff frequency and the slope used by this filter. These settings are only applied to the signal redirected to the Satellites.

NOTE: Bass Management mode must be set to On in order for these settings to be taken into account.

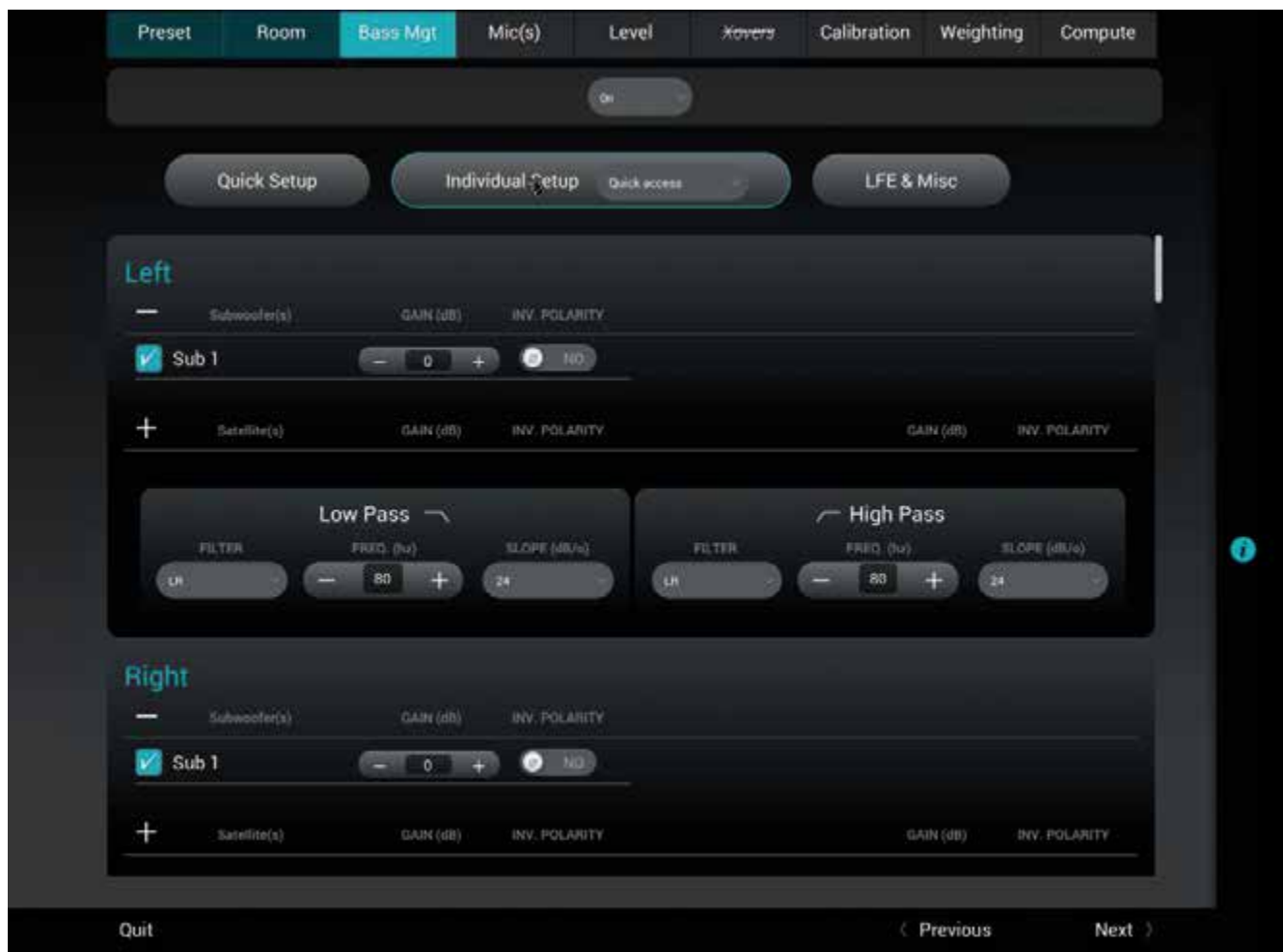

Figure 60: Configuring the bass management settings for every speaker



IMPORTANT NOTE: If there is no active sub for one or more satellite, the high-pass frequency is still active. If a full-range speaker is required, set the High-Pass filter type to None and it will disable the filter.

#### \_6.4.4.2 \_INTERMEDIATE BASS MANAGEMENT

The Intermediate Bass Management main purpose is to allow a speaker to be bass managed not only on a subwoofer but also on a satellite ("satellite" means "any speakers except subwoofers"). Note that the LFE channel can also be freely routed to any satellite.

Here are various examples of applications:

- **Dolby Up-Firing speakers:** Up-firing speakers require their low frequencies content to be reproduced by the speakers beneath them;
- **In-ceiling speakers:** In-ceiling speakers are usually smaller. It can be very useful to bass manage them with the closest bigger speaker (the bigger speaker being bass-managed to a subwoofer)
- **No subwoofer:** if the Home-Theater audio-system does not have any subwoofer but only 5/7 speakers able to reproduce very low frequencies, redirect the LFE to every speaker may be mandatory to keep the integrity on the content.



NOTE: Bass Management mode must be set to On in order for these settings to be taken into account.



To access the intermediate bass-management, please click on the "+ Satellites" of the speaker you want to bass-manage:



A new section is shown displaying a checkbox to every speaker (except the one you are bass-managing to avoid any feedback loop) will be unfold.



Here, you can select which bigger speaker will receive the redirected bass from the smaller speaker. In the example above, the in-ceiling Left Top Middle speaker will be bass-managed to the Left Surround speaker. In situation, the frequencies below 80Hz of the Left Top Middle speaker will be redirected to the Left Surround speaker, filter type being Linkwitz-Riley with 24dB/octave slope.

You can also adjust the gain and the polarity on the bass-managed signal. The gain of the speakers will not be affected, only the bass-managed signal will.

**!** IMPORTANT NOTE: The low pass and High Pass settings are in common between the sub(s) and the satellite(s). It means that all satellites will have one low pass filter and one high pass filter for their bass-management. In the example below, our Left Top Middle speaker is bass managed with Sub 1 and with Left Surround. Frequencies up to 80Hz will be handled by Sub 1 and Left Surround, in LR 24dB/octave, and frequencies from 80Hz and over will be handled by the Left Top Middle speaker.

**!** NOTE: To avoid bass-managing simultaneously in a speaker and in a subwoofer, we advise to apply the parameter on only a bigger speaker and bass-manage the bigger one to one or more subwoofer(s).

## 6.4.5 \_LFE & MISC

Every setting in the LFE & Misc are active even if the Bass-Management is Off.

LFE stands for “Low Frequency Effects,” and is an optional channel that may or may not be present in the source material, and which is the “.1” channel. LFE signals is usually reproduced by one or more subwoofer(s).

The page is divided as followed:

- A table allowing to assign the LFE channel of the content to one or more subwoofer(s);
- A “+ Satellite(s)” folded table giving the possibility to redirect the LFE channel to one or more satellite
- A **Low Pass – LFE** section to set a filter on the LFE channel;
- A **Misc.** section with various options.

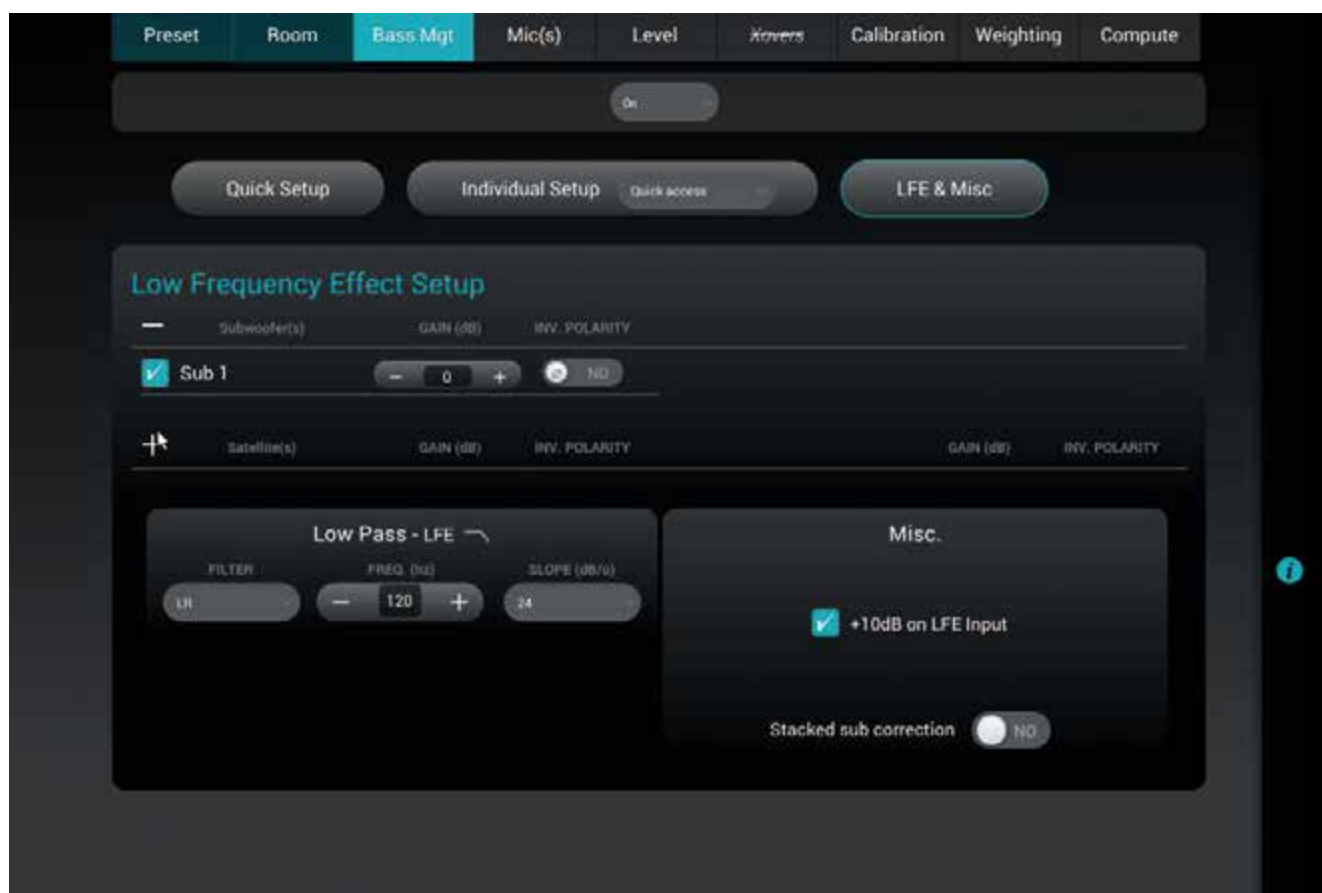

Figure 61: LFE & Misc page

### \_6.4.5.1 \_LOW FREQUENCY EFFECT SETUP

This first section is here to choose which subwoofer is assigned to the LFE channel. A subwoofer assigned to the LFE will play the .1 of the content.

To assign the LFE channel to a subwoofer, please tick the box of the desired subwoofer.

The LFE signal can be filtered. A Low Pass filter is available and only apply on the LFE channel (not on the subwoofer(s) assigned).

**Low Pass – LFE:** This setting will determine the cutoff frequency of the LFE channel. You can select the type of filter (Linkwitz-Riley, Bessel or Butterworth), the cutoff frequency and the slope used by this filter.

### \_6.4.5.2 \_REDIRECT LFE CHANNEL TO ONE OR MORE SATELLITE(S)

If the Home-Theater audio system has no subwoofer but several speakers with the ability to reproduce very low frequencies, it is possible to redirect the LFE channel to one or more satellite(s). To do so, simply select

the speakers in which the LFE channel will be played.

When the system has no subwoofer declared, the section + Satellite(s) is unfolded by default.

In the example below, the LFE channel will be played on Left, Center, Right:

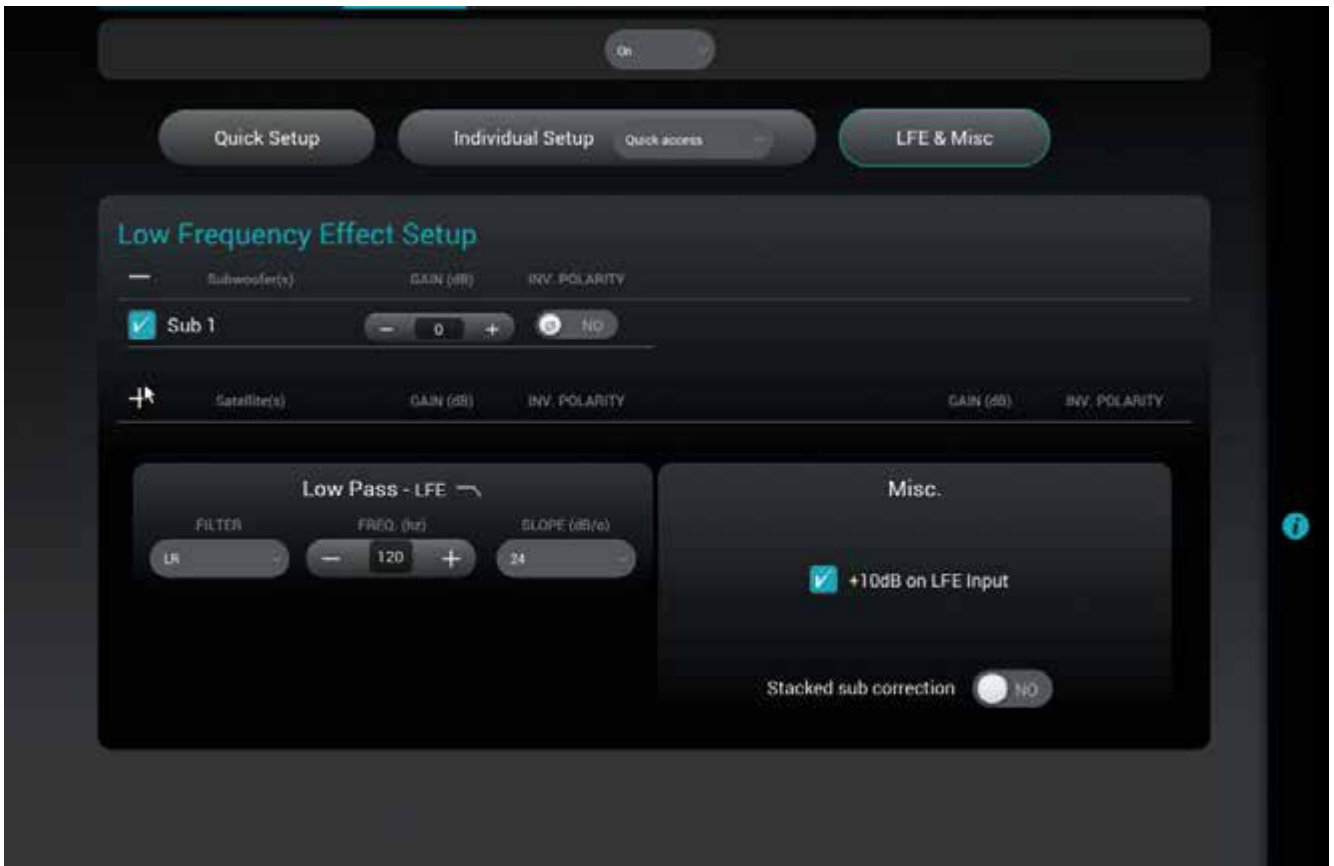

Figure 62: Level of attenuation and the Stacked Subs option

#### \_6.4.5.3 \_+10 DB ON LFE

Unless the encoded bitstream signal is decoded upstream by another device, the +10dB on LFE input option should be enabled (default). It applies a gain of 10dB on the incoming LFE signal. The default is almost always the correct setting.

#### \_6.4.5.4 \_STACKED SUB CORRECTION

The Stacked sub-option is designed for stacked multiple-subwoofers configurations.

When multiple subwoofers are used to reproduce the same signal, the perceived level increases. The Altitude<sup>32</sup> automatically decreases the signal sent to each subwoofer to maintain the same perceived level depending on the number of subwoofers used to reproduce the same signal. The attenuation varies, depending upon whether the subwoofers are located very close to each other, or are located well away from each other, which is typically the case.

In such multiple subwoofers configurations, two typical cases are handled by the Altitude<sup>32</sup>:

- If subwoofers are considered as decorrelated (away from each other), their power adds up.
- If subwoofers are considered as correlated (positioned next to each other or stacked), their amplitude add up.

Therefore, whether the stacked sub option is disabled (default) or enabled, an automatic attenuation of the signals will be calculated accordingly to maintain a consistent level.

NUMBER SUBWOOFERS IN THE SYSTEM	ATTENUATION IF "STACKED SUBS" DISABLED	ATTENUATION IF "STACKED SUBS" ENABLED
2 subwoofers	-3 dB	-6 dB
3 subwoofers	-4.8 dB	-9.5 dB
4 subwoofers	-6 dB	-12 dB

## 6.5 \_USING TRINNOV 3D MICROPHONE

The measurement microphone is one of the most critical components of a room calibration system. Trinnov's 3D measurement is the result of our extensive research in 3D sound.

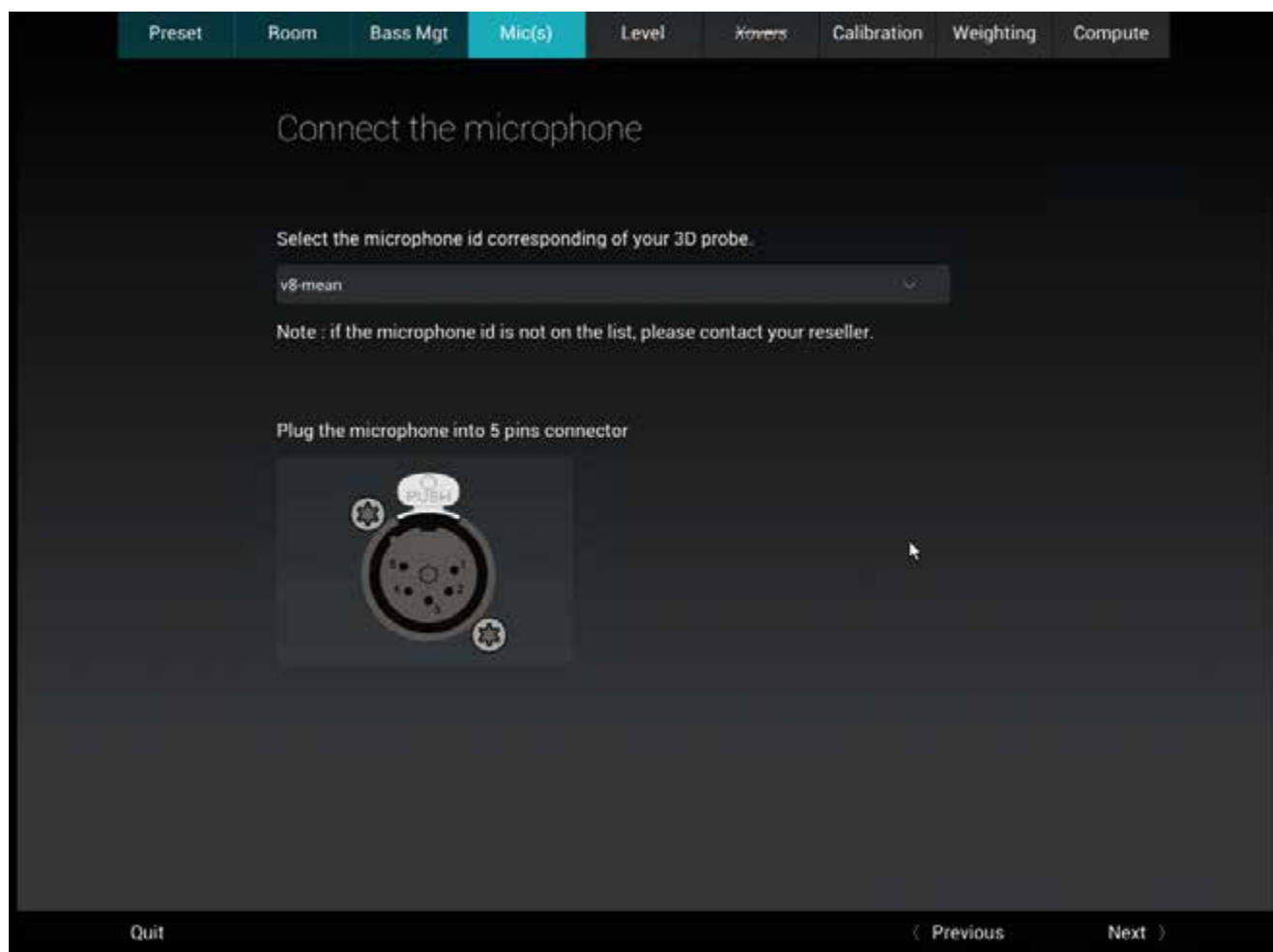

Figure 63: Connect the microphone

The Altitude<sup>32</sup> is only delivered with a 5-pin connector. As said at the beginning of this quick setup, you need to load the corresponding microphone compensation file to fully use the Trinnov Audio Optimizer. Once the right file selected, you can go to the next step.

### 6.51 \_THEORETICAL REQUIREMENTS FOR THE MEASUREMENT ENVIRONMENT

When you are calibrating your room, you have to do it as close as you will listen to your system in a normal situation. But, knowing what a perfect environment should be, might sometimes explain issues during calibration.

Theoretically, a few basic rules should be respected to ensure a robust measurement:

- No obstacle between the speaker and the microphone.
- No highly reflecting surface (leather sofa, glass table...) close to the microphone.
- No background noise during the measurements (Air conditioning, open doors, windows etc...)
- No movement during calibration (disturbs speaker localization)

### 6.5.2 \_REFERENCE MEASUREMENT POINT

The Altitude<sup>32</sup> supports single-point and multi-point calibrations. In both scenarios, a reference measurement position should be chosen carefully since it will be used by the Optimizer for:

- Cross-over driver alignment
- Loudspeaker 3D localization
- Loudspeaker 2D/3D remapping
- Loudspeaker relative delay/level alignment
- Master delay/level calculation

A reference measurement point defines the central point of your whole room. Generally, it would be right in front of the screen, on the main listening position. If your reference point is not positioned correctly, it will decrease the final results of the calibration. We advise you to set the reference point very carefully (For example, be careful that your microphone is not inclined on its stand).

### 6.5.3 \_POSITION AND ORIENTATION OF THE MICROPHONE FOR THE REFERENCE POINT

The calibration microphone should be placed at the listening position, using the listener's ears as a reference for its height. When the microphone is powered on, a **red led** shows the front of the microphone. The red led must be pointed to the **front** of the sound stage, towards the **center speaker**.

During the calibration process, the microphone should be attached to a microphone stand or camera tripod.

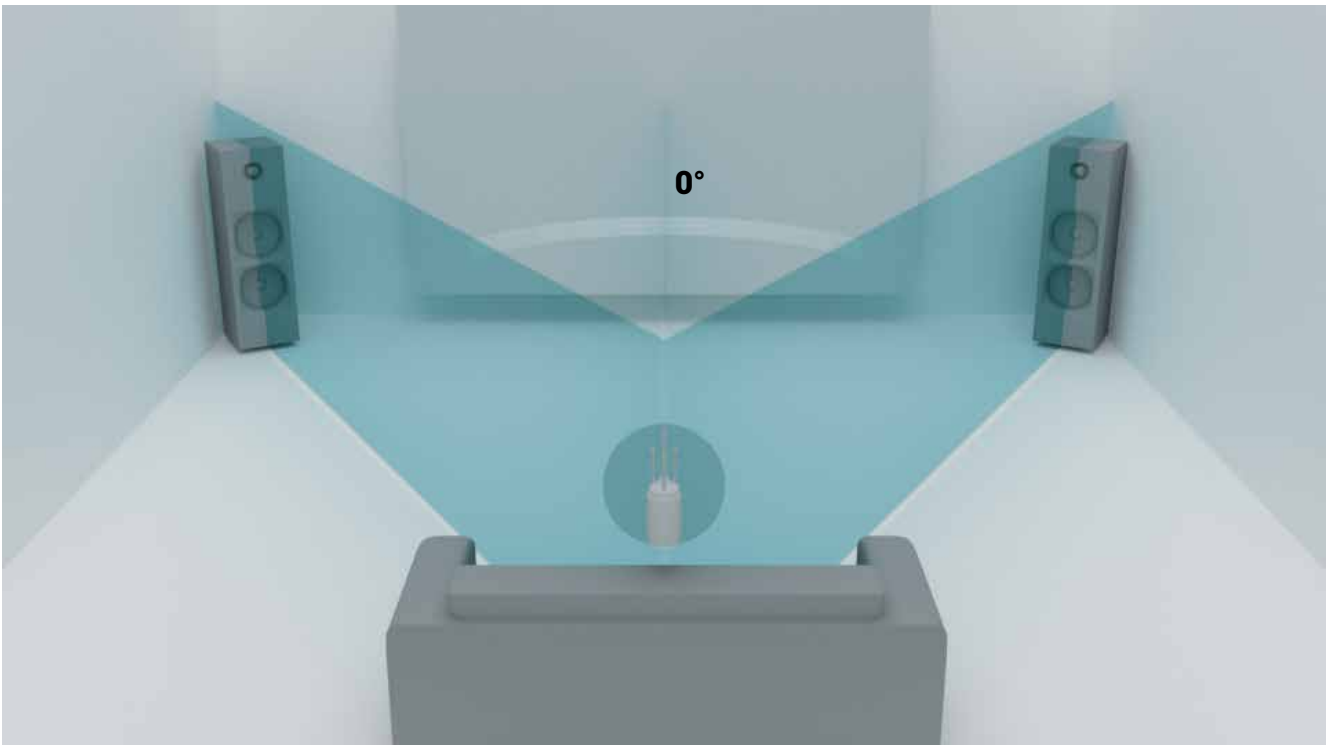

Figure 64: Microphone reference position

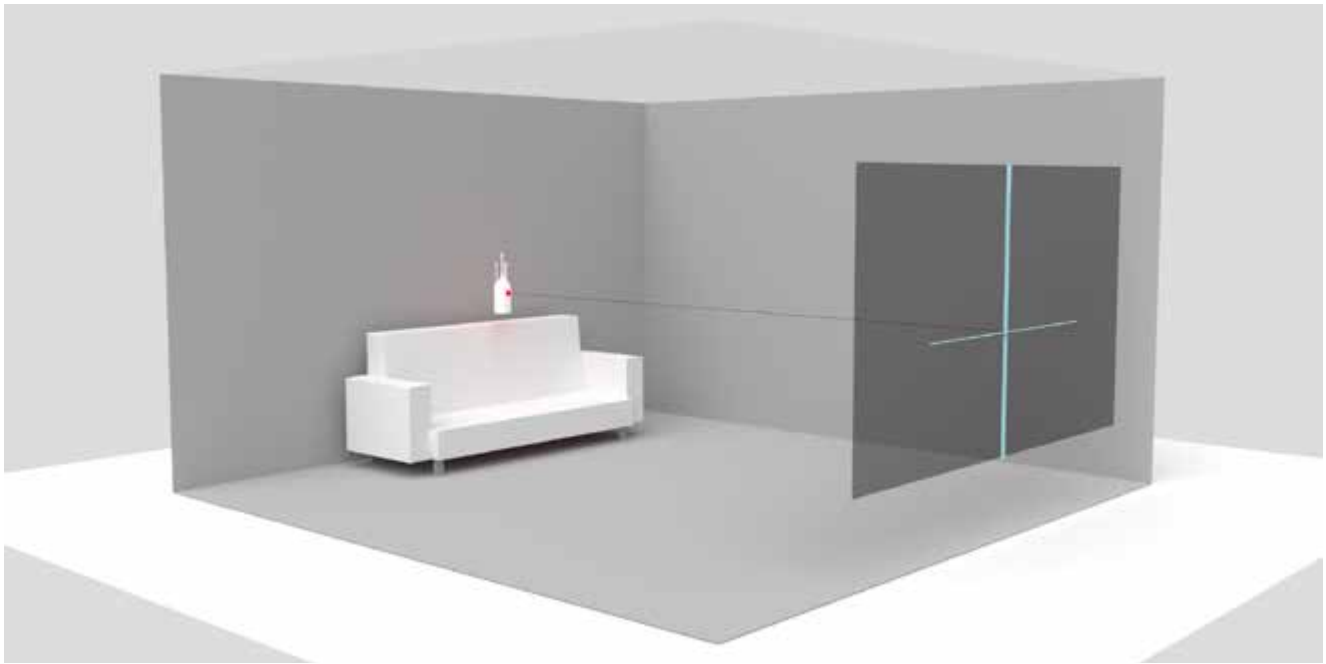

Figure 65: Remove the microphone protection and turn on the microphone.

NOTE: At this step of the Wizard the volume has been automatically muted to protect your speakers of any feedback loop.

## 6.6\_SETTING THE VOLUME FOR THE CALIBRATION

This step will help you set up the right volume for a maximized calibration. The volume has been set by default to -40dB to protect your ears and your speakers.

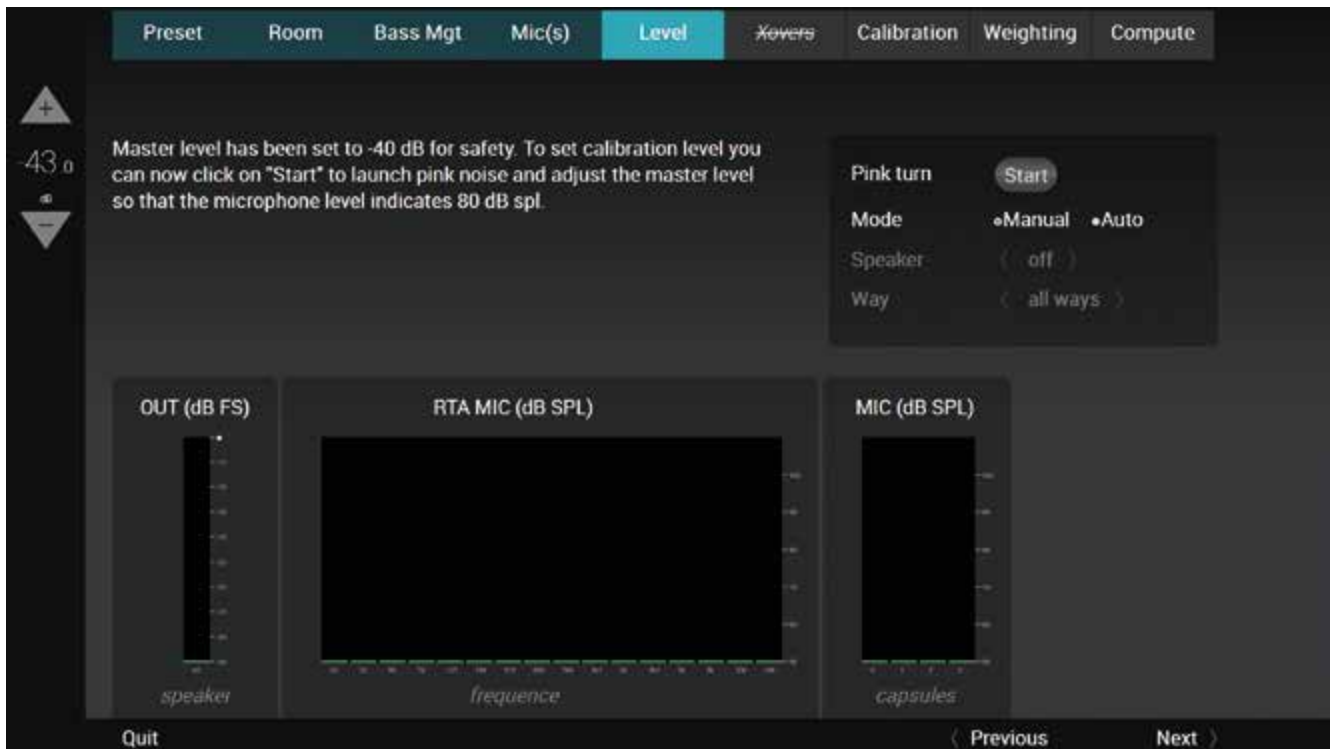

Figure 66: Level configuration window

OUT (dB FS) shows the strength of the output signal.

RTA MIC (dB SPL) shows the strength of the signal regarding the frequency on the capsule 0 of the microphone (the top one of the microphone).

MIC (dB SPL) shows the strength of the signal received by each capsule of the microphone.

MIC LEVEL is the summary of the previous one. It shows the median value of the 4 capsules.

- **Blue:** The signal is too low.
- **Green:** The signal is in range (78-82).
- **Red:** The signal is too loud.

By clicking on Start, you begin playing a pink noise at the current volume.

You can choose to set the mode on Auto (all channels will be heard one after the other) or on Manual (you will have to change the speaker manually).

If you configured a multi-way channel, you can hear the low / medium / high speaker depending of your configuration.

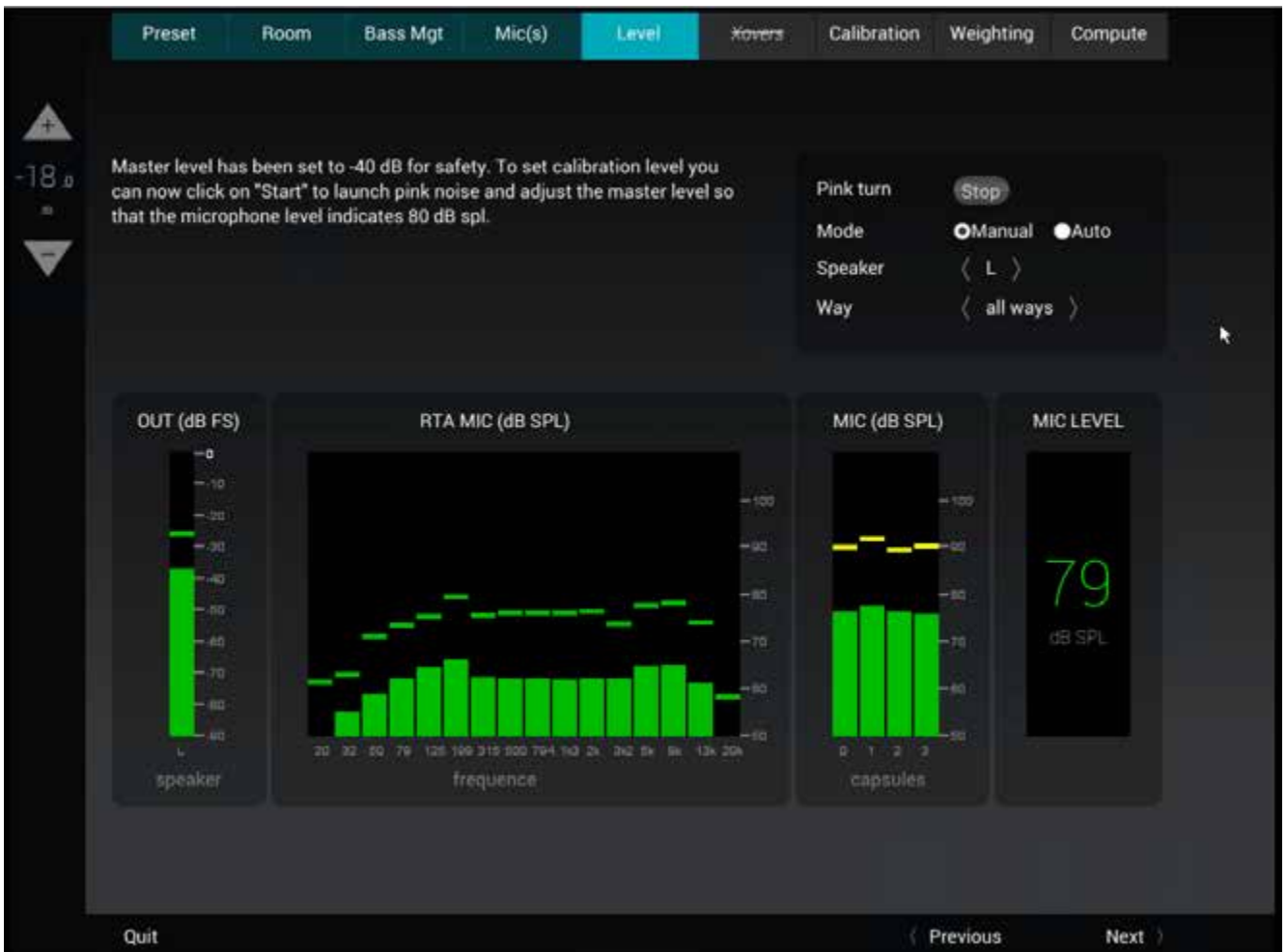

Figure 67: Metering the mic level

To set correctly the volume, you will have to increase the volume until the MIC LEVEL reach 80 dB SPL.

**!** NOTE: This value is a reference that works most of the time but it's not an obligation. You have to set the volume as close as you would hear music or a movie in a normal situation. The idea is to ensure that the signal-to-noise ratio ("crest factor") of the measurement is excellent.

## 6.7 \_SETTING THE CROSSOVERS (OPTIONAL)

This chapter explains how to calibrate the active crossovers included in the Altitude<sup>32</sup>. It assumes that you are familiar with active crossovers and multi-amplified speakers and is not intended as a course. If you are not using the active crossover functionality of the Altitude<sup>32</sup>, please skip to the next chapter.

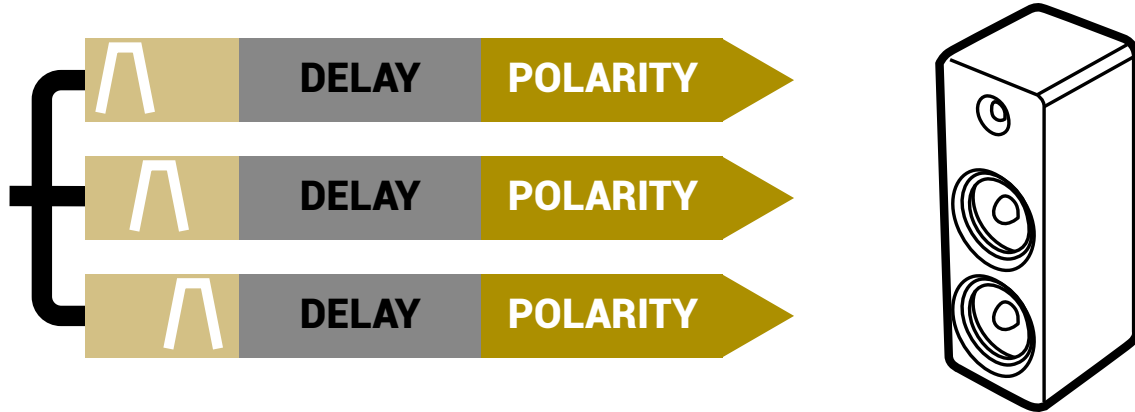

Figure 68: Overview of the active crossovers signal flow

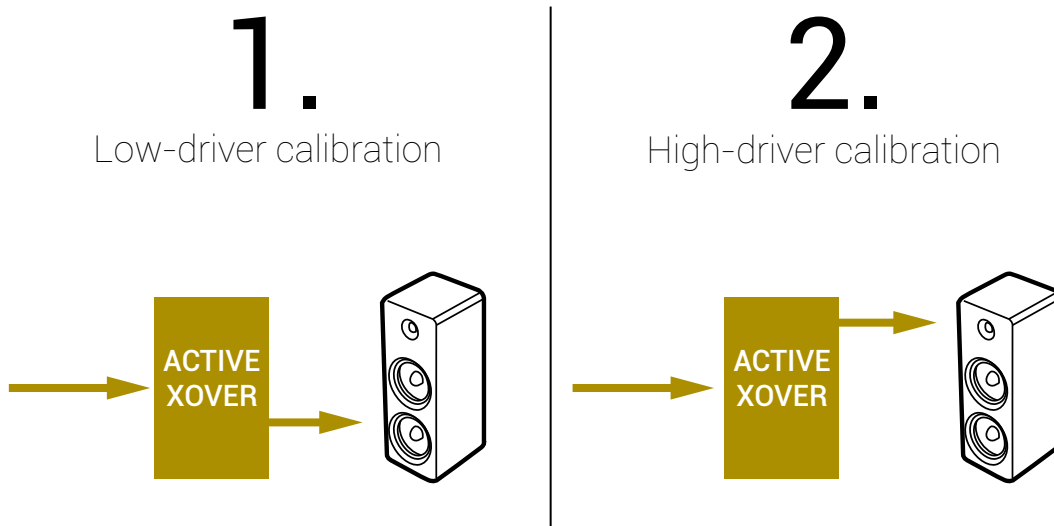

Figure 69: the steps of the calibration process



## \_6.7.1 \_OVERVIEW OF THE CROSSOVER SETUP PROCEDURE

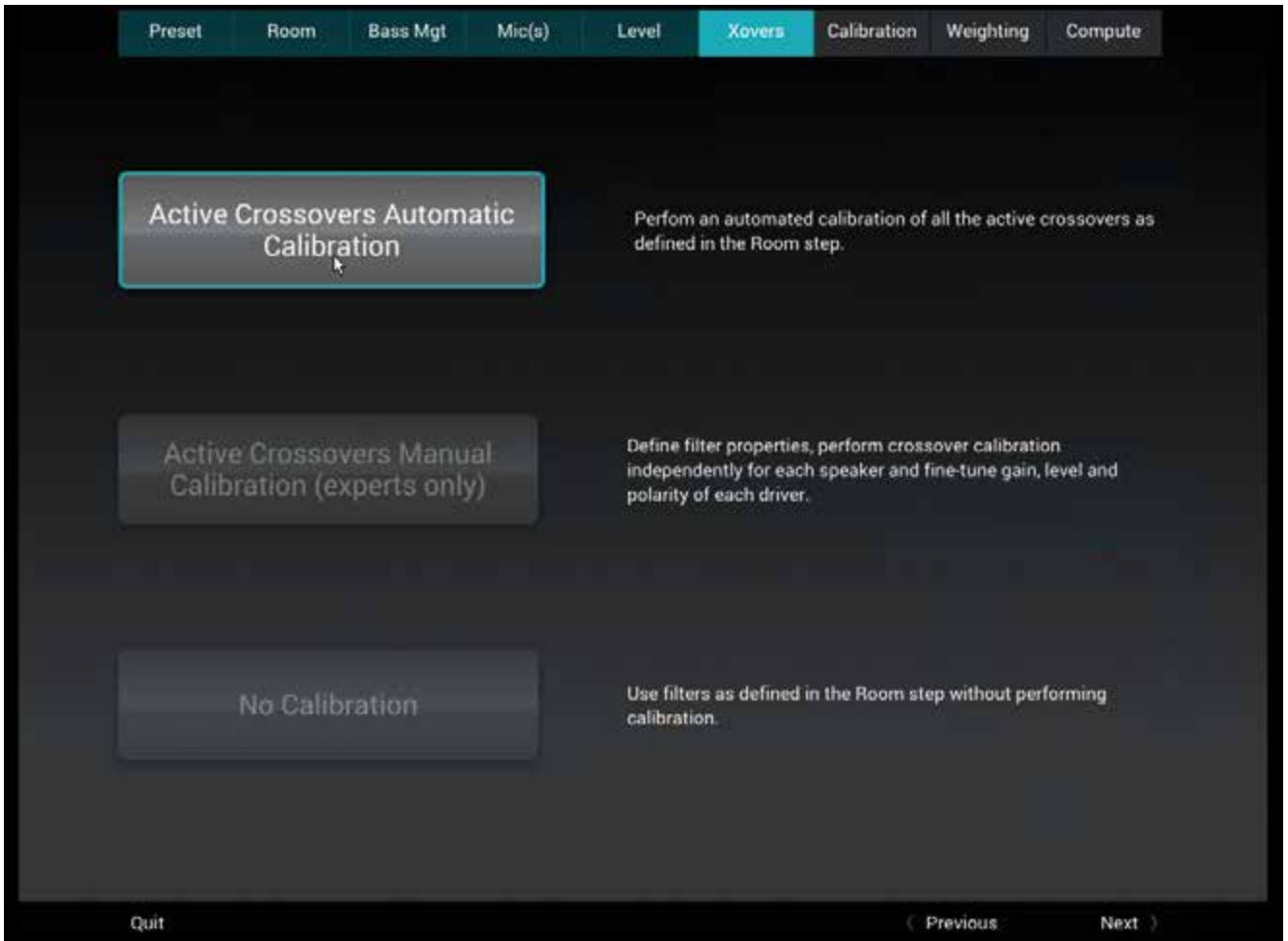

Figure 70: Set the type of calibration for the crossover

**When performing the Wizard Setup, you will have three ways to calibrate the crossovers:**

**Active filters auto calibration:** the crossovers will be automatically calibrated. This will automatically determine the level, delay and polarity of each driver. The filters applied in the 3D view of the Wizard will be taken into account.

**Active filters manual calibration:** only for experts, allow the possibility to change what the Optimizer has determined after the calibration, by manually adjust levels, delays and polarities of each driver. The filters applied in the 3D view of the Wizard will be taken into account but you can manually change them.

**No calibration:** jump directly to the next step without modifying the delay or the level of the crossovers (set at 0). The filters applied in the 3D view of the Wizard will be take in account.

When you calibrate a crossover, you will probably have to increase the volume. Effectively, as the MLS signal is split to 2, 3 or 4 ways, it will lose in strength. The goal is to raise the level of the test signal far enough above the background noise in the room that we can be certain of a high quality measurement.

Once the procedure is chosen, click on Next.

## 6.7.2 \_ACTIVE FILTERS AUTO CALIBRATION

The list of your multi-way speaker(s) is shown on the picture above.

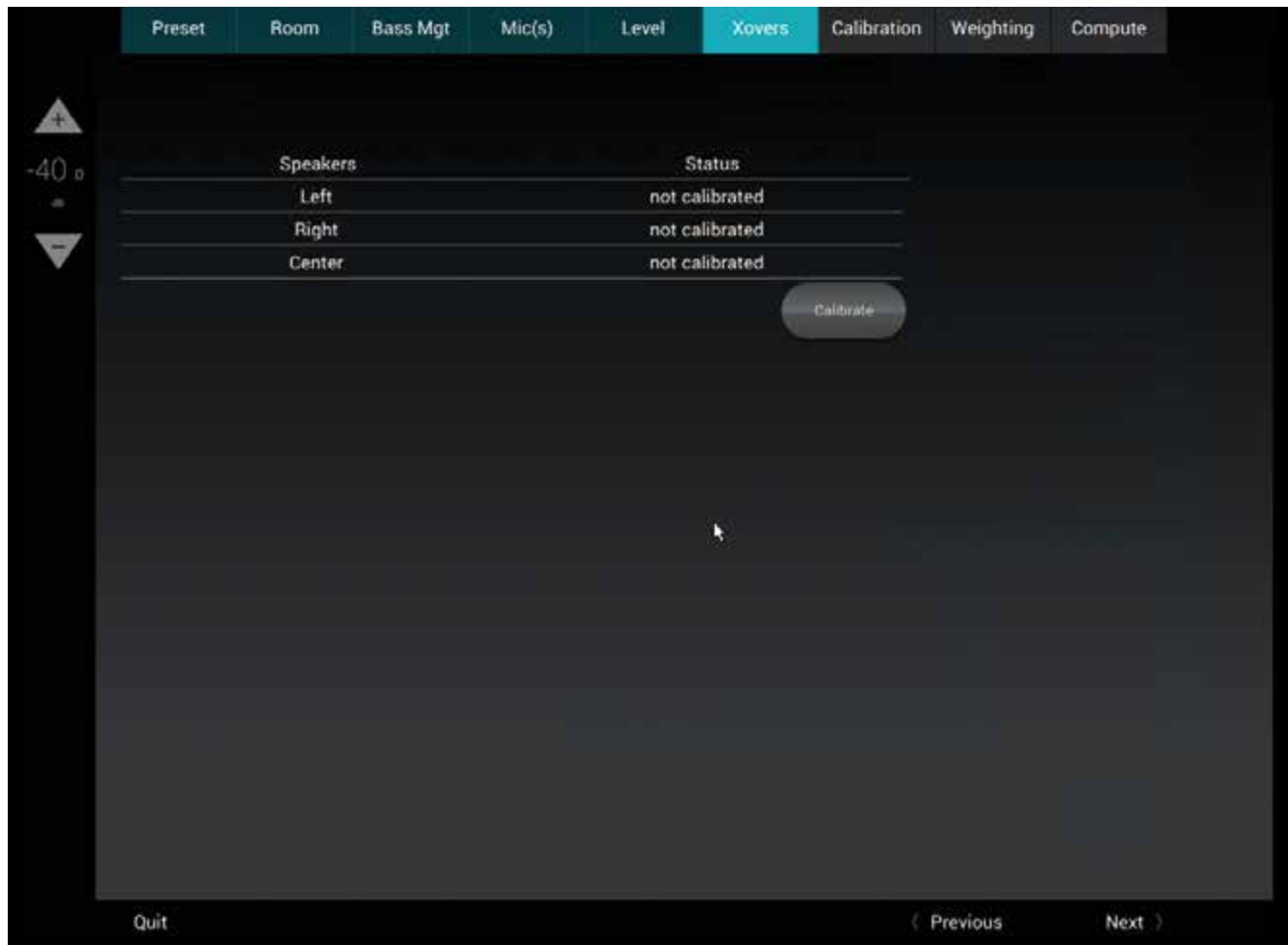

*Figure 71: Calibrate the multi-way speaker*

The status indicate if the calibration has been done. Click on Calibrate to launch the calibration. All speakers will be calibrate following the order of the list.



NOTE: This value is a reference that works most of the time but it's not an obligation. You have to set the volume as close as you would hear music or a movie in a normal situation.

## 6.7.3 \_ACTIVE FILTERS MANUAL CALIBRATION (EXPERTS ONLY)

### \_6.7.3.1 \_SETTING THE CROSSOVERS

The following screenshots have been taken with a 5.1 speaker Layout (L, C, R are two-way speakers).



Figure 72: Calibrate manually a crossover

The top of the screen shows all the multi-way speakers. The selected current speaker is highlighted in blue while the others are highlighted in grey. The same type (number of ways) of multi-way speaker can be linked. When different speakers are linked, all changes done on one of them will be automatically applied on the others.

**!** NOTE: If one of your multi-way speaker is not listed or if you don't hear the right number of MLS burst, please go back to the Room step of the Wizard to configure the correct number of ways

The following settings are available for each loudspeaker:

- The **type** of high-pass or/and low-pass filters is chosen;
- The **cut-off frequency** of each filter is set by using the – or + or by manually entering the frequency;
- **Level** and **delay** can be adjusted on each way (driver);
- **Mute** and **Invert Polarity** buttons are also available;
- Two additional IIR filters are available under the name of **“Constant-directivity horn” EQ** and **Half “Constant-directivity horn” EQ**. The purpose of such filters is to boost the high frequencies for speakers that use constant-directivity horns. These speakers tend to have too little energy at the highest frequencies in sweet spots. Depending on the horn you are using, you may want to boost the high frequencies by 3 or 6 dB/oct, from about 3kHz.

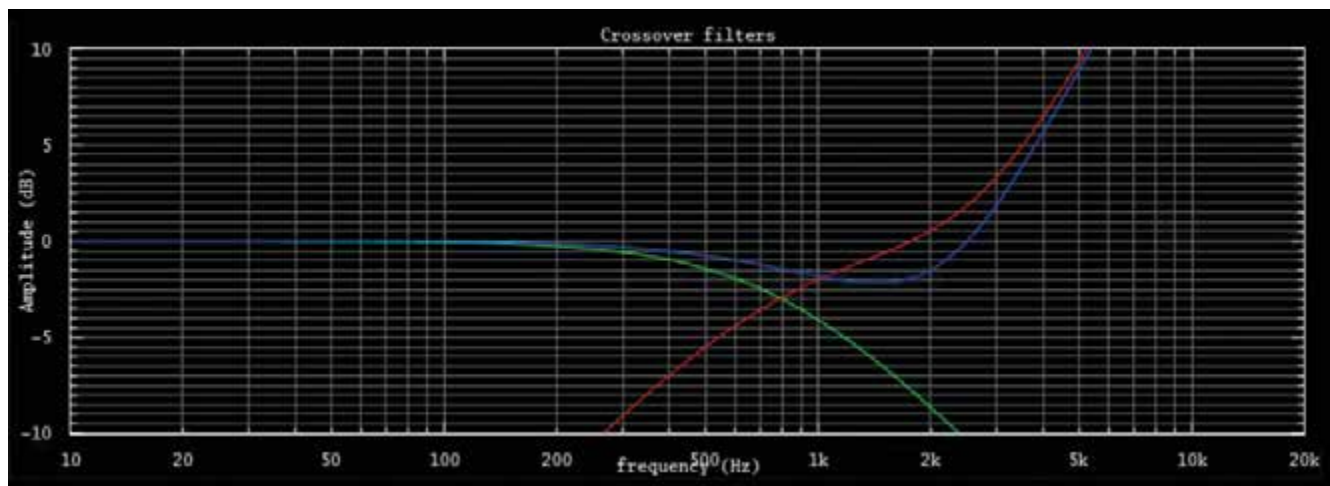

Figure 73: Constant-directivity horn EQs

The Altitude<sup>32</sup> can use different types of filters and a different order for those filters:

- Bessel order 2, 3 and 4;
- Linkwitz-Riley order 2, 4, 6 and 8;
- Butterworth order 1, 2, 3, 4, 6 and 8.

The Apply button is highlighted as soon as a parameter is modified. If you don't click on it, the changes will not be taken in to account in the calibration of the crossover.

If the changes are unwanted, press the Cancel Changes button to cancel your modifications.

The theoretical model of the specified filters is represented as follows:

- The green curve represents the theoretical low-pass filter response
- The red curve represents the theoretical high-pass filter response
- The blue curve represents the theoretical hi-pass and low pass filter for the Mid speaker in a tri-amplification. It will represent the theoretical hi-pass and low pass filter for the LMid speaker in a quadri-amplification
- The purple curve represents the theoretical hi-pass and low pass filter for the HMid speaker in a quadri-amplification
- The yellow line represents the theoretical resulting in the blue, red and green curves.

You can zoom on the curve by using the wheel of your mouse. You can also click on the graph and move the mouse to see other parts of the graph.

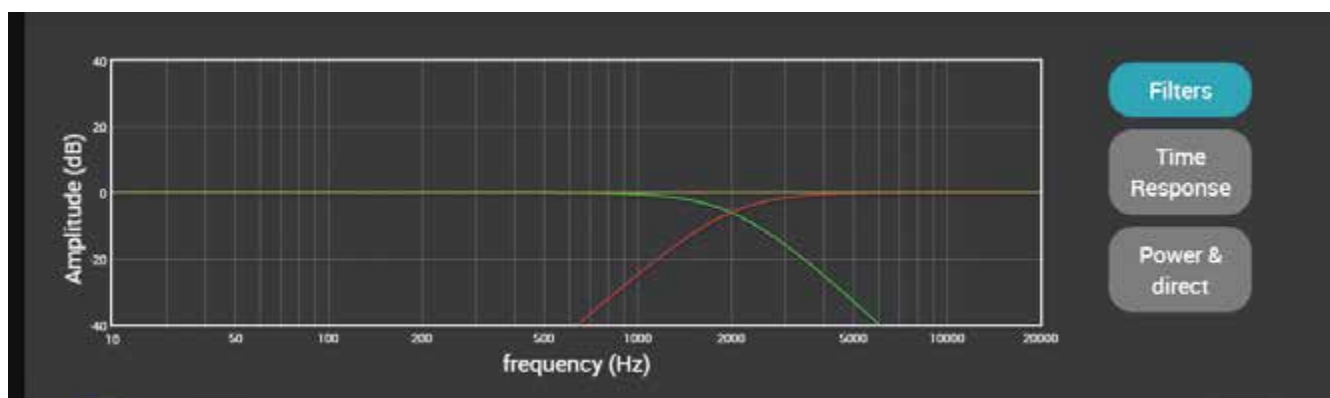

Figure 74: Bi-amplification

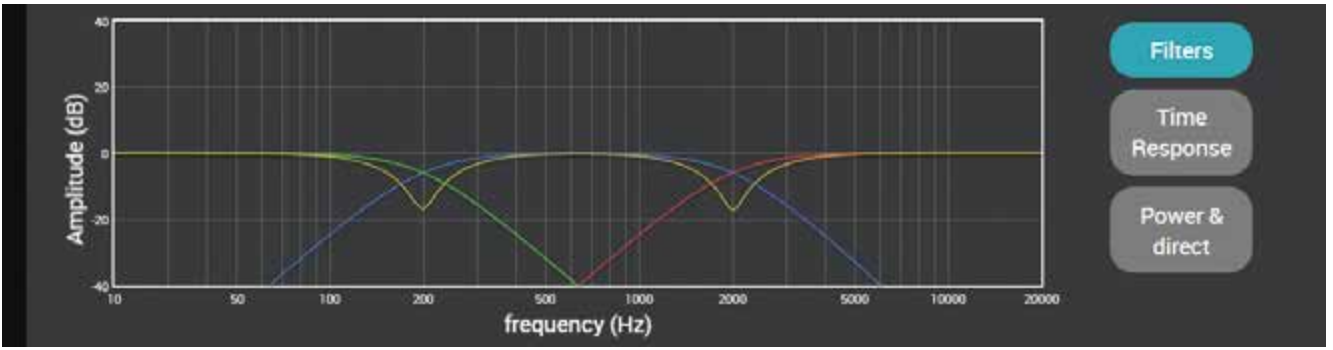

Figure 75: Tri-amplification

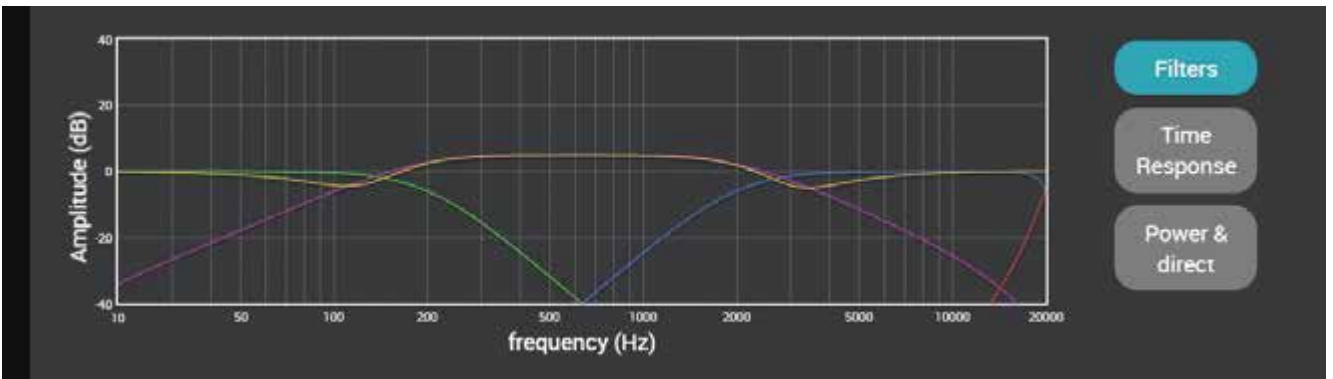

Figure 76: Quadri-amplification

\_6.7.3.2 \_CALIBRATING THE CROSSOVERS

When your system is not yet calibrated, the time response and power & direct are not available. The system will indicate "Need to calibrate".

Once you have set the frequency cut and the type of the filter you want to use, click on Calibrate.

The system will calibrate the speaker you have selected or some speakers if they are linked.

**!** NOTE: If the system can't calibrate and show a pop-up message: "crest factor to low" or "unstable position", you can increase the volume on the left top of the screen.

The following screenshots has been taken with a 5.1 speaker Layout (L, C, R are two-way speakers).

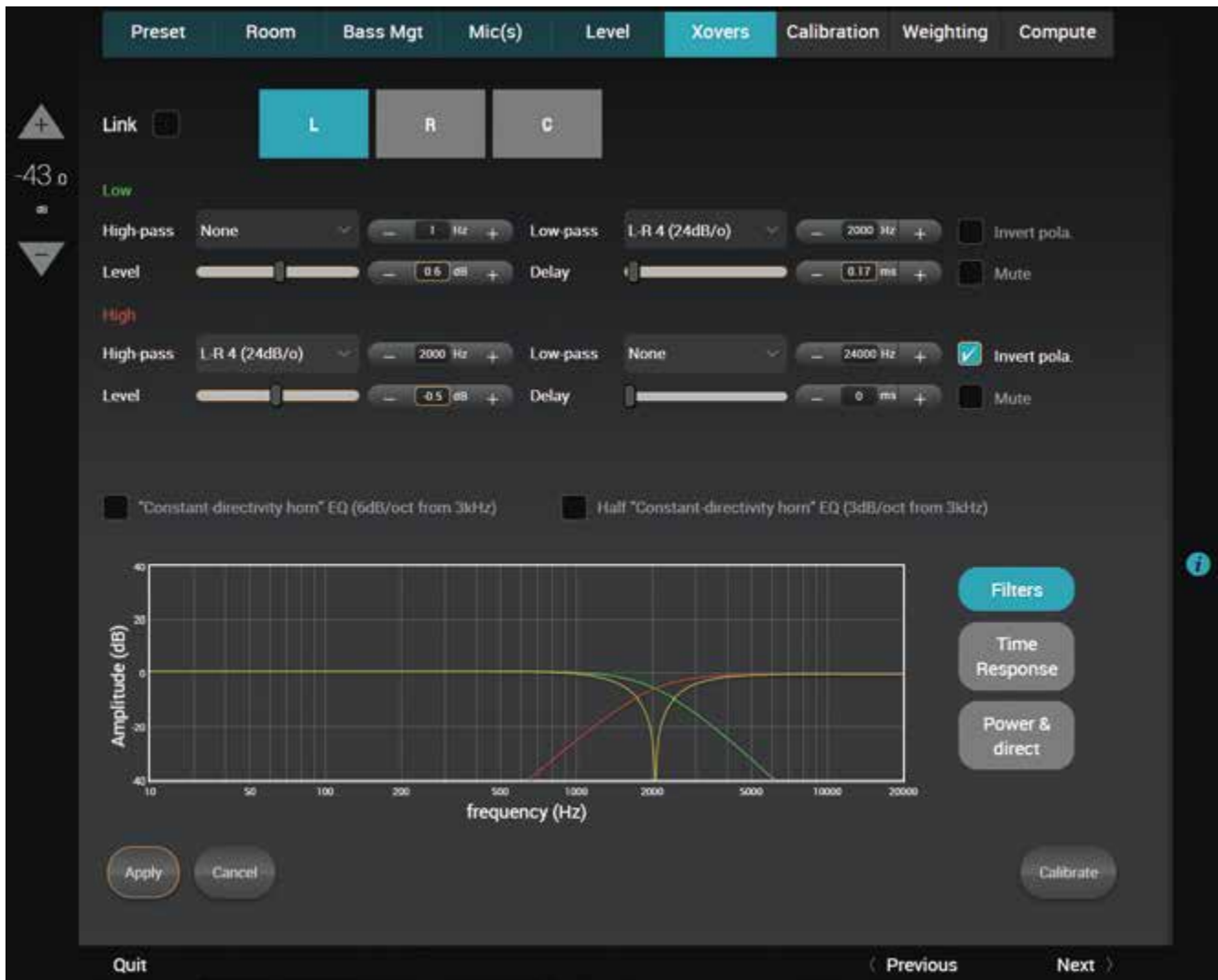

Figure 77: Crossover after calibration

• Low-speaker	• High-speaker
• Level: +0.6 dB	• Level: -0.5 dB
• Delay +0.17 ms	• Delay: +0 ms

As we can see the Optimizer has modified the curve with the applied results.

NOTE: As you can see the Optimizer has inverted the polarity of the High speaker.



Figure 78: Measured time response of both drivers

We can also see the measured time response of each way: you can see whether the drivers are correctly synchronized.



Figure 79: frequency response (power and direct)

The recombined amplitude response of the speaker: You can see whether the combination of the drivers is constructive and you can observe the effects of level/delay/polarity modification on the combined amplitude of the speaker. Two curves are displayed : one showing the total acoustic output of the speaker (including the room), the other showing the amplitude of the direct front and early reflections. Comparing both curves will indicate whether the crossover preserves the directivity of the speaker: The two curves will look more alike when the acoustic summation is optimized for the primary listening position.



**NOTE:**

- The levels, delays and polarities set previously are ignored during the calibration. In other words, adjusting these parameters before launching the calibration will have no effect on the result.
- Under some circumstances, the automatic crossover algorithm may suggest inverted polarities for a driver from one speaker to another. This can be explained by various factors:
  - The physical polarity of one speaker is, indeed, inverted (from a cabling issue, as an example). In this case, the correction suggested by the Optimizer should be applied to improve audio quality
  - Two adjacent drivers (for instance Mid and High) are phase-shifted by an amount of about 90°. In this case, the Optimizer provides more uncertain results as it gets harder to see whether the drivers are in or out of phase. If you are not comfortable with the results provided by the Optimizer, you can correct them manually afterwards (via the button "Invert polarity").

Click on Next. The Wizard will show you the multi-way speaker and their status. You can select the speakers that are not calibrated and click on Calibrate to calibrate them.

## 6.7.4 \_NO CALIBRATION

- | You can also choose to pass the crossover calibration by clicking on No Calibration.

## 6.8 \_CALIBRATION

- | At this step of the Wizard your system is ready to be calibrated.

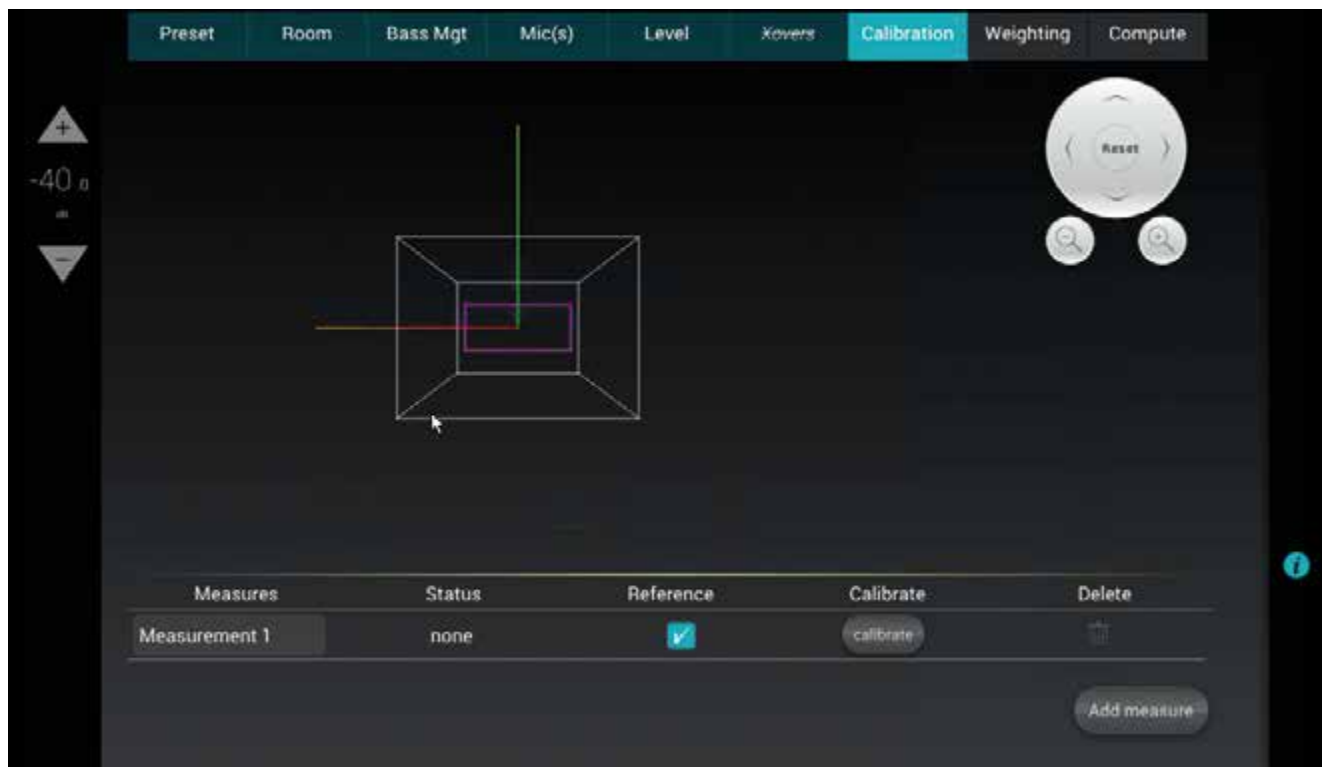

Figure 80: Calibration step in the Wizard



## 6.8.1 \_SINGLE-POINT CALIBRATION

If you are only interested by the calibration of one point of measurement (normally the reference hearing point of your system) you may already click on Calibrate. The system will automatically start by sending MLS Burst to your speakers.



### NOTES:

- The calibration tool plays three MLS bursts for every speakers and subwoofers. If the calibration goes wrong, please see the section 6.10.3 of this manual. The calibration will add the speaker position related to the reference point during the calibration.

The calibration status has 3 possible values:

- **Complete:** If no problem occurred during the measurement. After calibration, the system is calibrated but not ready to be used, which means no sound can go through the processor until the optimization filters are computed.
- **Partial:** If the calibration was stopped in the middle of the measurement process.
- **None:** When no measurement has been performed.

Once the status of the calibration indicates complete, you can click on Next. Since there is only one measurement point, you can skip the weighting step.

## 6.8.2 \_MULTI-POINT CALIBRATION

One of the most advanced features of the Altitude<sup>32</sup> is its unique multi-point measurement technology. Instead of using an averaged response out of multiple measurement points, the Trinnov Multi-point Algorithm can take every single measurement point into account.

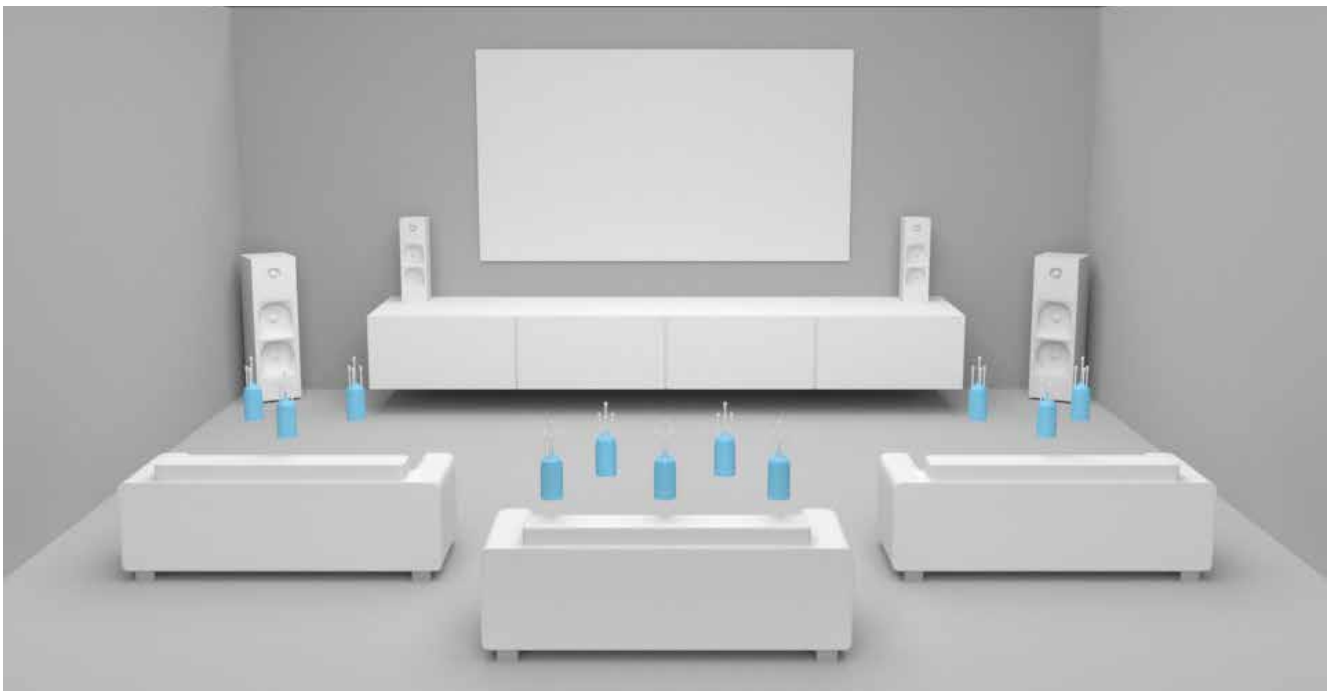

The purpose of multi-point measurement is not only to optimize a wider listening area but also to get more information from measurements and increase reliability by taking into account important variations in the listening area.



NOTE: The multi-point approach ensures a more reliable calibration but choosing relevant microphone positions is highly critical.

There are no fixed rules about choosing multi-point measurement positions. However, measuring outside of the area covered by the speakers can be considered as irrelevant.

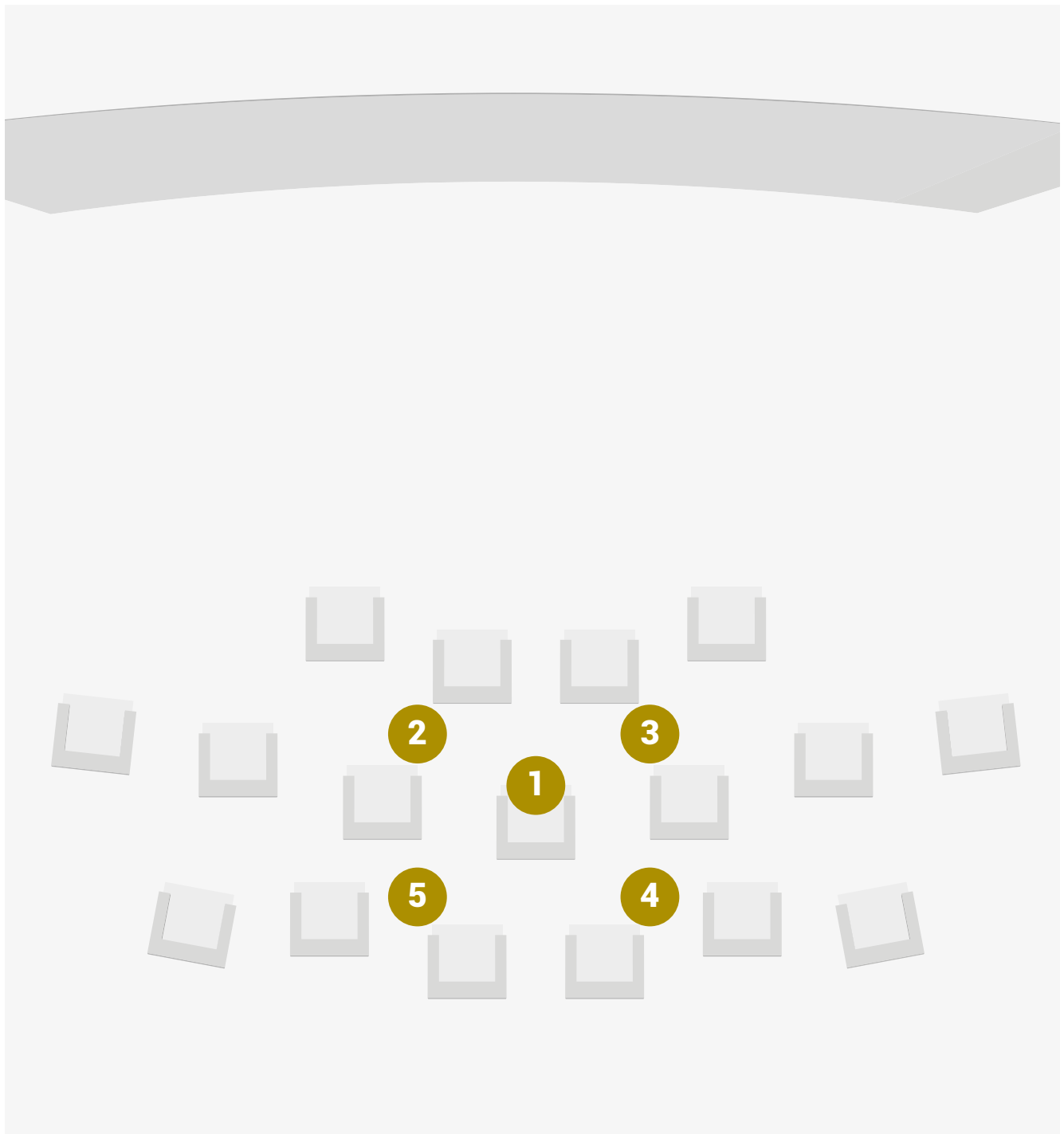

*Figure 81: Relevant multi-point measurement positions*

As an example, multi-point measurements can be performed for a single listening position:



NOTE: The number of measurement points are limited by the hardware of the unit. Indeed, the memory charge will increase by adding a point. For the Altitude<sup>32</sup>, we suggest that you don't have more than 10 measurement points.

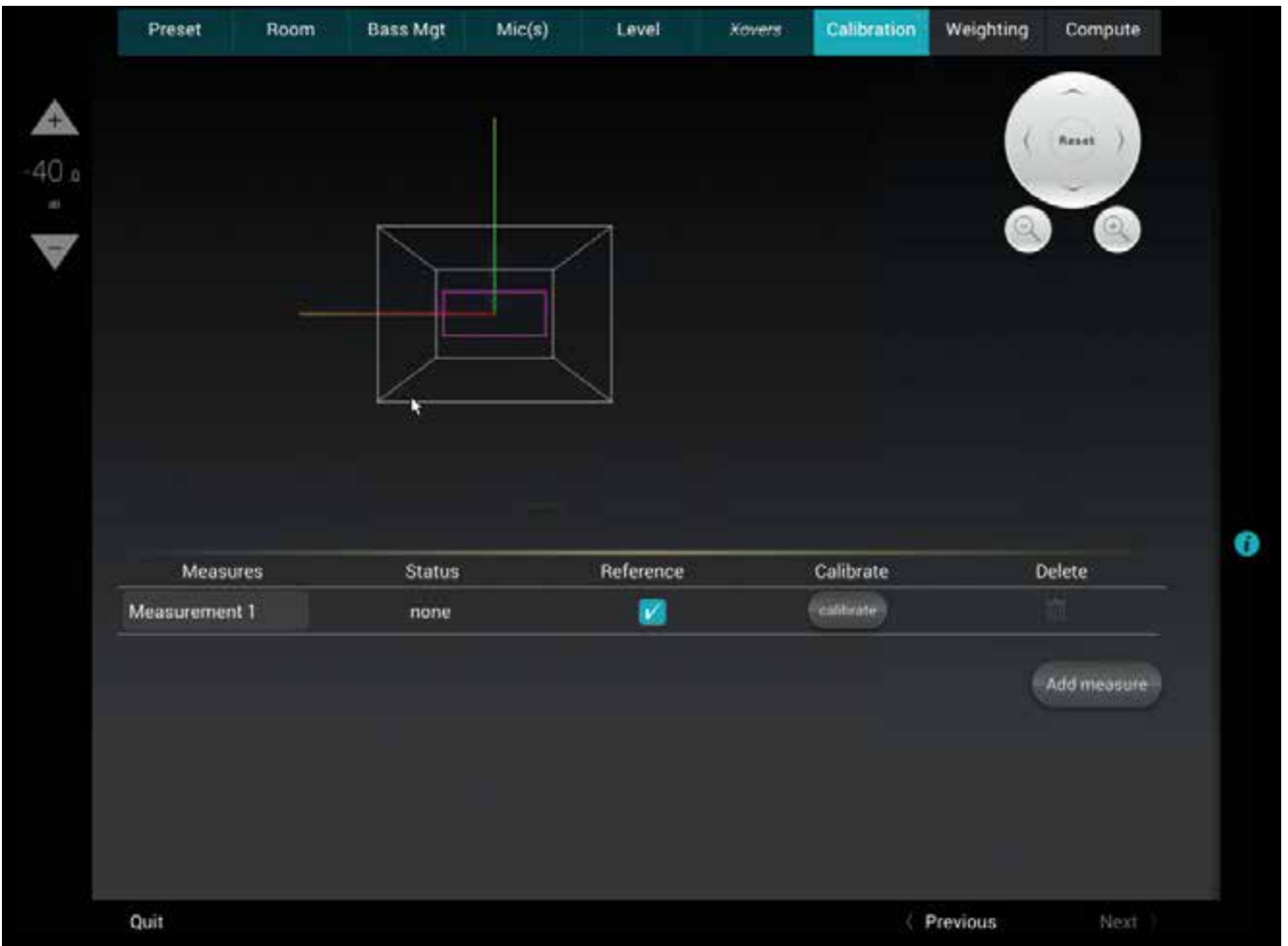

Figure 82: Multi-point measurement before calibration

Click on Add measure to add a new measurement point. By default, all the measurements are called Measurement X, but you can rename them if you want to remember specific points.

All the multi-points measurement are organized around a reference point. This point is specific and has to exist to calibrate. It shows the point of measurement that represents the most important point in your Room. Generally, it will be used for the armchair of the main user or a central area in front of the screen.

**!** NOTE: The reference point does not mean that it is the most used point in the calibration. The importance of each points will relatively be set in the Weighting Step. The reference point is the point use in the 3D view to place the screen and all speakers found during the calibration as well as to set the precise level and delay values for all of the speakers relative to each other.

For each point you will have to calibrate the system. The system will automatically start sending MLS Bursts to your speakers.

**!** NOTES: The calibration tool plays three MLS bursts for every speakers and subwoofers. If the calibration goes wrong, please see the section 6.10.3 of this manual. The calibration will add the speaker position related to the reference point as and when the calibration.

The calibration status has 3 possible values:

- **Complete:** If no problem occurred during the measurement. After calibration, the system is calibrated but not ready to use, which means no sound can go through the processor until the optimization filters are computed.
- **Partial:** If the calibration was stopped in the middle of the measurement process.
- **None:** When no measurement has been performed.

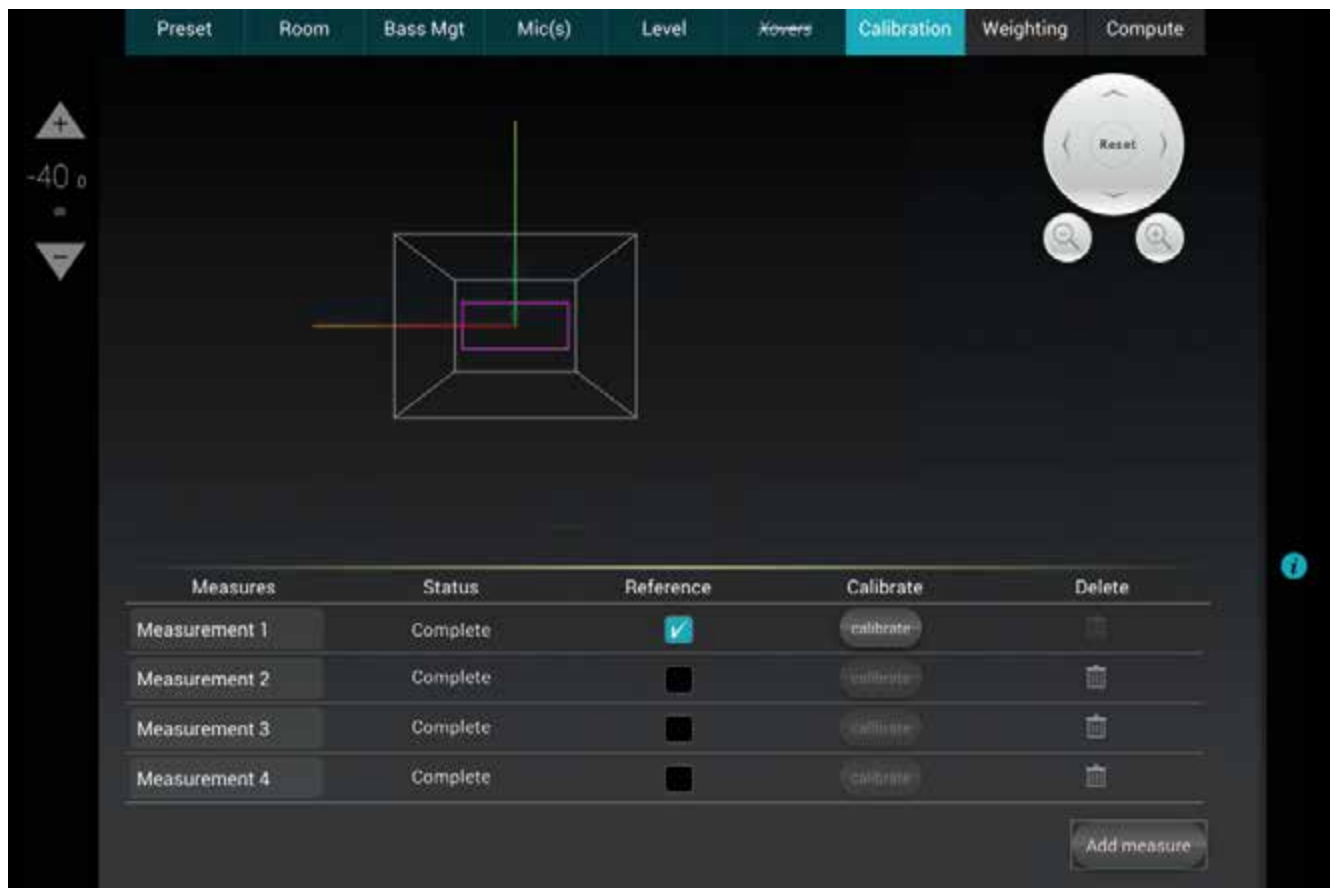

Figure 83: Multi-point measurement after calibration

Once the status of all calibration indicates complete, you can click on Next.

### 6.8.3 \_COMMON PROBLEMS DURING CALIBRATION

If the calibration tool plays more than 3 MLS bursts for a speaker, it means that it's finding it difficult to perform a reliable measurement of that speaker.

The most common warning messages are explained below:

#### “Crest factor too low for capsules”:

- Check the Input Meters in the Processor/Meters page.
- If the Input level is null on at least one of the 4 channels, go back to the Optimizer Settings/Calibration page and stop the calibration.
- Check that the selected analog physical input is selected in the Home/Select page.
- Make sure the microphone routing is correct.
- The microphone battery may be low. The red led at the front of the microphone indicates the battery level.
- The microphone or cable could also be damaged.

#### “Unstable position for speaker”:

- Someone may have moved during the calibration.
- Too many strong reflections around the microphone environment disturb the impulse response measurement.
- An obstacle between the microphone and any of the speakers can disturb the measurement.
- The bandwidth of one of the speakers may be too narrow.
- “Unable to localize speaker”:
- Dipole/bipole speakers provide more than one wave at the same time, which can cause issues.
- Several speakers chained providing more than one wave at the same time.

## 6.8.4 \_WEIGHTING

The weighting step will allow you to make a balance between all of your measurement points.

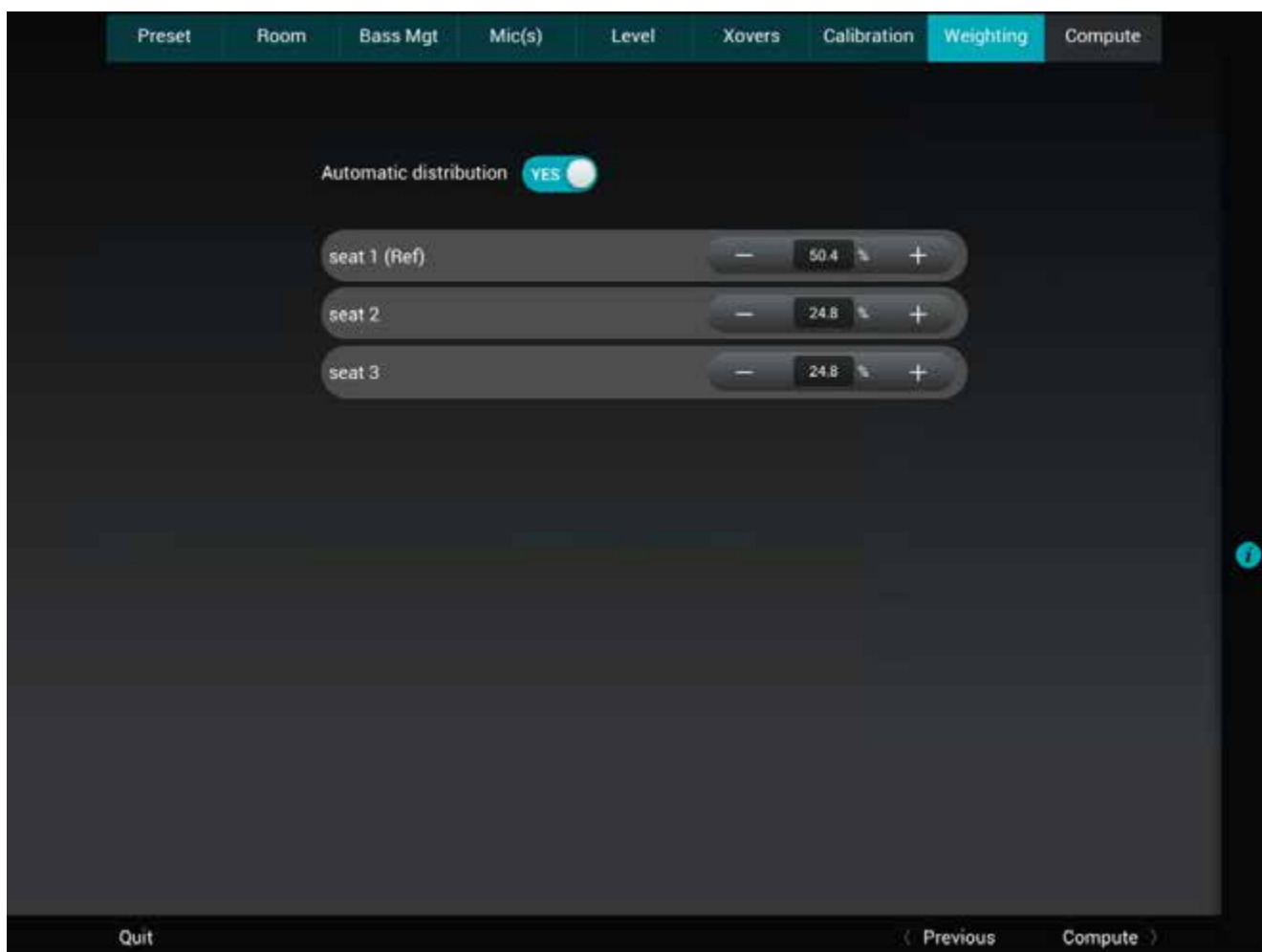

Figure 84: Weighting step of the Wizard

By letting the Automatic distribution on Yes, the system will automatically compensate all the changes that you made and will bring the calculation to 100%.

You can add more weight about one measurement or retrieve another one.

This step will depend on the utilization that you planned.

If the Automatic distribution is on NO, you can exceed 100%. Remember that the weighting compares the relative difference between the different points, not the number itself.

## 6.9 \_COMPUTE

Once the calibration is done, the system has already set in its memory all the data of your Room. But, to be able to use them, you will have to calculate the filters that have to be applied to your current Room. This is the Compute step.



Figure 85: Computing step

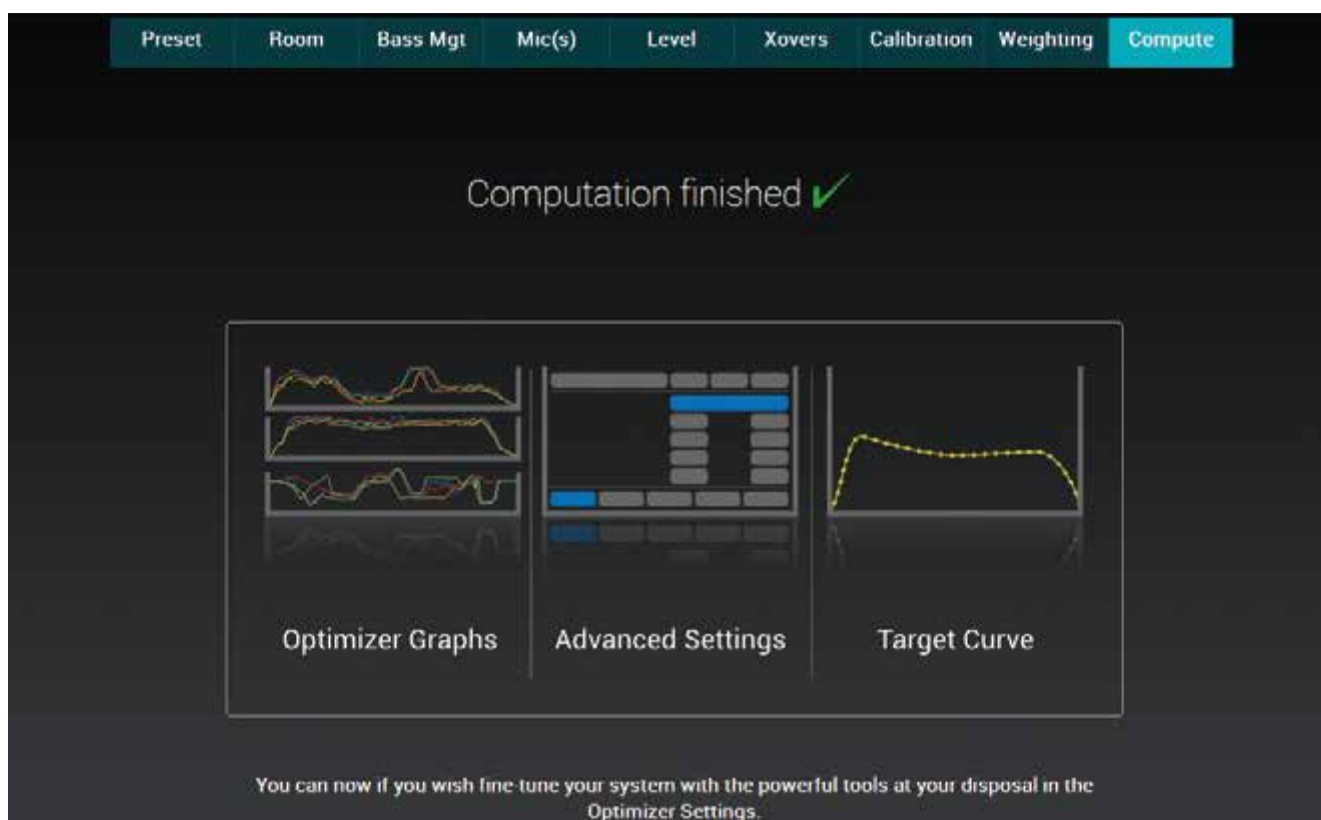

Figure 86: End of the computing step

The Wizard is now finished. Your entire configuration has been saved in the current preset that you chose at the beginning of the Wizard. You can now click on Finish to close the window.



Your system is now ready to be used. Please, don't forget to turn off the microphone. The system has been automatically muted and set to -40dB for safety.

## 6.10 \_ANALYZING THE RESULTS

The Altitude<sup>32</sup> is a complete and flexible tool for displaying the correction filters as well as the responses of the speakers *before and after* the Trinnov optimization.

The acoustical graphs are available in the **Optimizer Graphs** page of the Advanced user interface. It is possible to display the acoustic responses of multiple speakers and analyze the information from various points of view: amplitude, phase, group delay, impulse response...

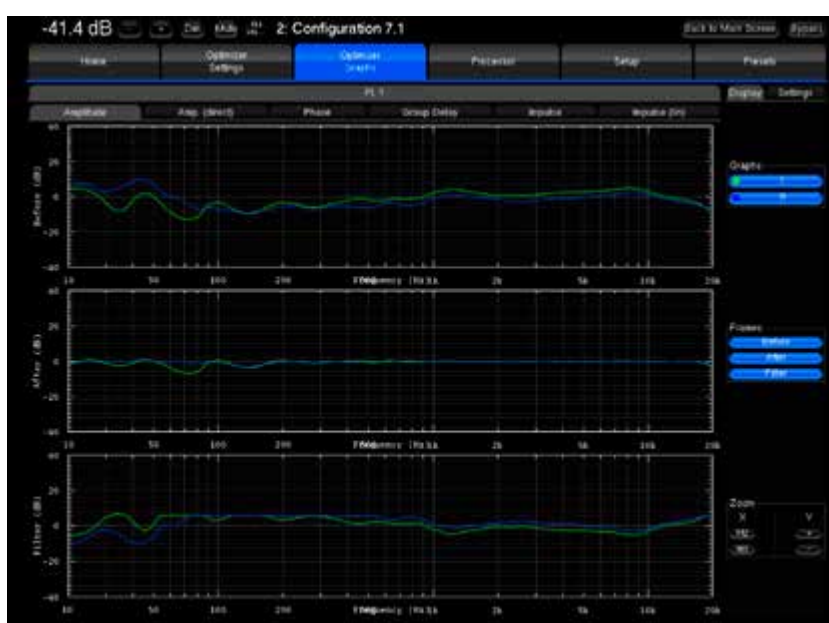

Figure 87: optimizer graphs page

## 6.10.1 \_IMPORTANT NOTES

It is important to understand the information available on these graphs:

- The “after” graphs show the effects of the optimization parameters. These graphs are therefore based on calculations only, not on measurements. However, measurements with external test systems have always proved the accuracy of these calculations.
- These graphs only take into account the automatic filters computed according to the Optimizer Settings page, not the manual adjustments made in the Processor page.
- The display settings will be saved in preset.

## 6.10.2 \_GRAPHS DISPLAY OPTIONS

The Optimizer Graphs page consists of a display area on the left and a Config area on the right.

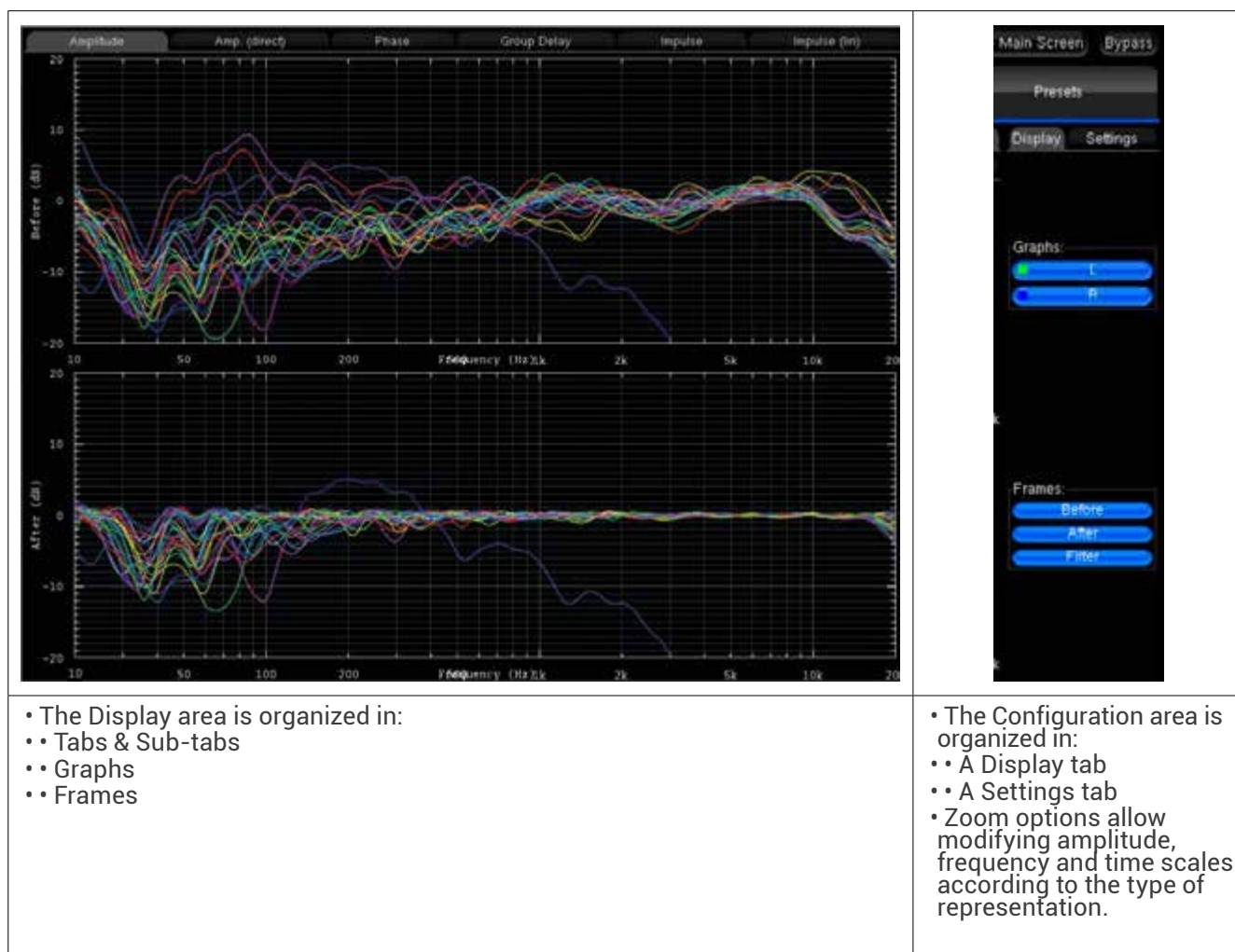

- The Display area is organized in:
  - Tabs & Sub-tabs
  - Graphs
  - Frames

- The Configuration area is organized in:
  - A Display tab
  - A Settings tab
  - Zoom options allow modifying amplitude, frequency and time scales according to the type of representation.



### 6.10.3 \_CHOOSE DISPLAY OPTIONS ACCORDING TO YOUR REQUIREMENTS

The flexibility of this feature allows you to visualize on the same screen various types of data, which you can organize as you wish by a few parameters:

- The **Graphs Overlay**: type of data you want to overlay on the same graph (or **Frame**)
- The **Frames**: type of data displayed vertically on the same tab
- The type of data you want to visualize on each **tab** and **sub-tab**.

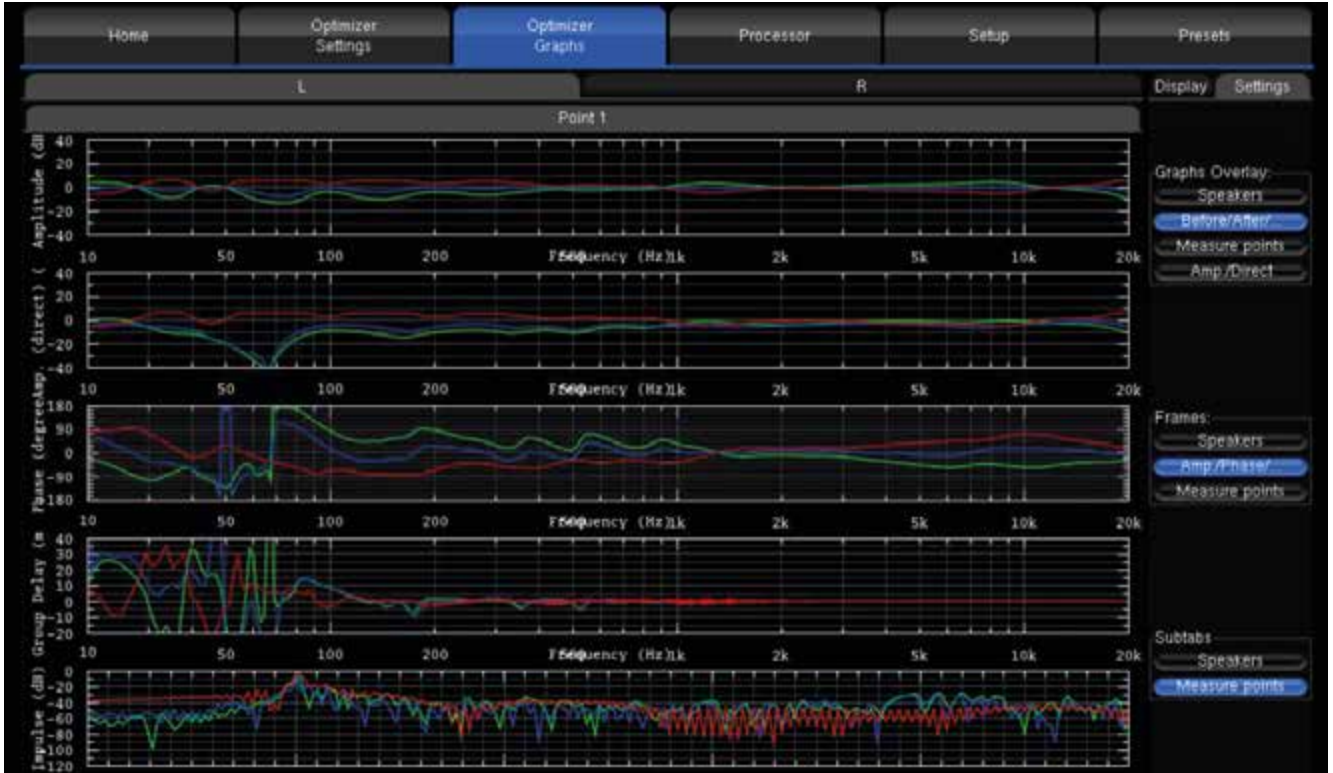

Figure 88: Comprehensive acoustical graphs

For each level, you can order the data through various criteria:

- The **speaker** (L, R, C, Sub, ...)
- The **point of measurement**: in the case of a multipoint configuration, you can visualize the response measured on each position, and the effect the optimization has on it
- The **type of response**: speaker response before optimization, speaker response after optimization or filter response
- The **type of visualization**: amplitude, the amplitude of the direct front and early reflections only, phase, group delay, or impulse response.

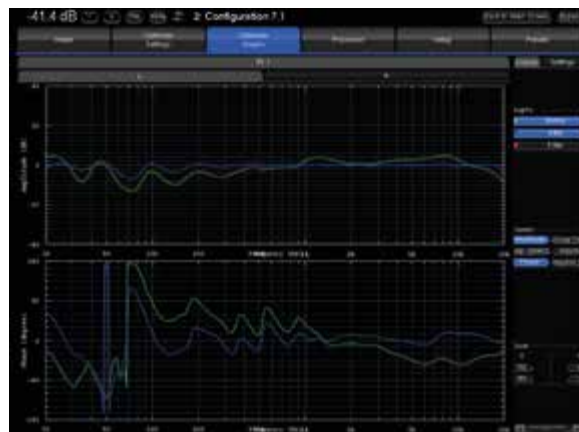

Figure 89: Focusing on specific graphs

## 6.11 \_CHECKING THE SPEAKER POSITIONS AFTER CALIBRATION

The **Optimizer Settings/Positions** page displays the measured speaker locations in real-time during calibration.

Three views are provided:

- Top view: The speakers are seen from above;
- Elevation view: The speakers are seen from the listening point. Relative degrees of elevation and azimuth are displayed;
- Details view: A table listing the measured distance, elevation, azimuth, level, delay etc...

By default, the Optimizer page always displays the reference speaker positions in green color. These positions are specified in the template of the initial speaker layout (2.0, 5.1, 7.1 or one of the Atmos, Auro-3D, DTS or Trinnov layouts).

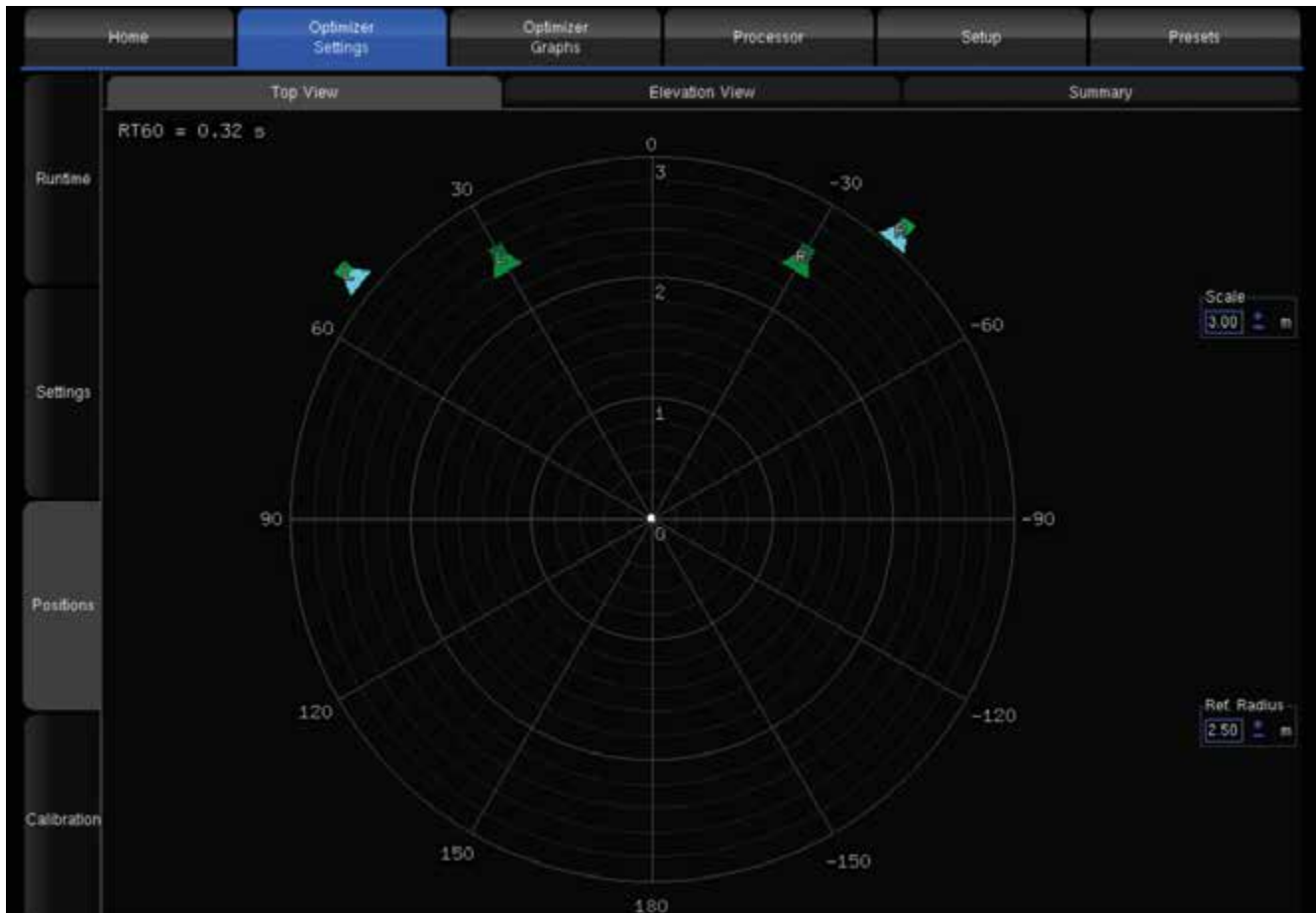

Figure 90: Top view of a layout after calibration

As the calibration is performed, the real position of each speaker is displayed after the 3rd MLS burst.

The **Top View** helps to identify the wrong speaker placements. It might be necessary to reposition if the microphone is not perfectly pointed towards the center of the front stage, but that would only impact the visual representation.



Figure 91: RT60 display

This view also provides the RT60 on the top left corner of the page.

- Overlay both representations with the Scale and Ref. Radius options to verify the compliance with the recommended placements.
- The channel name displayed on each speaker is related to the channel order defined in the Speakers/Room setup tool.
- The color of the loudspeakers depends on remapping settings.
- The Elevation View uses the same color codes to display the real speaker positions. It indicates whether the microphone was or was not correctly leveled during the calibration:

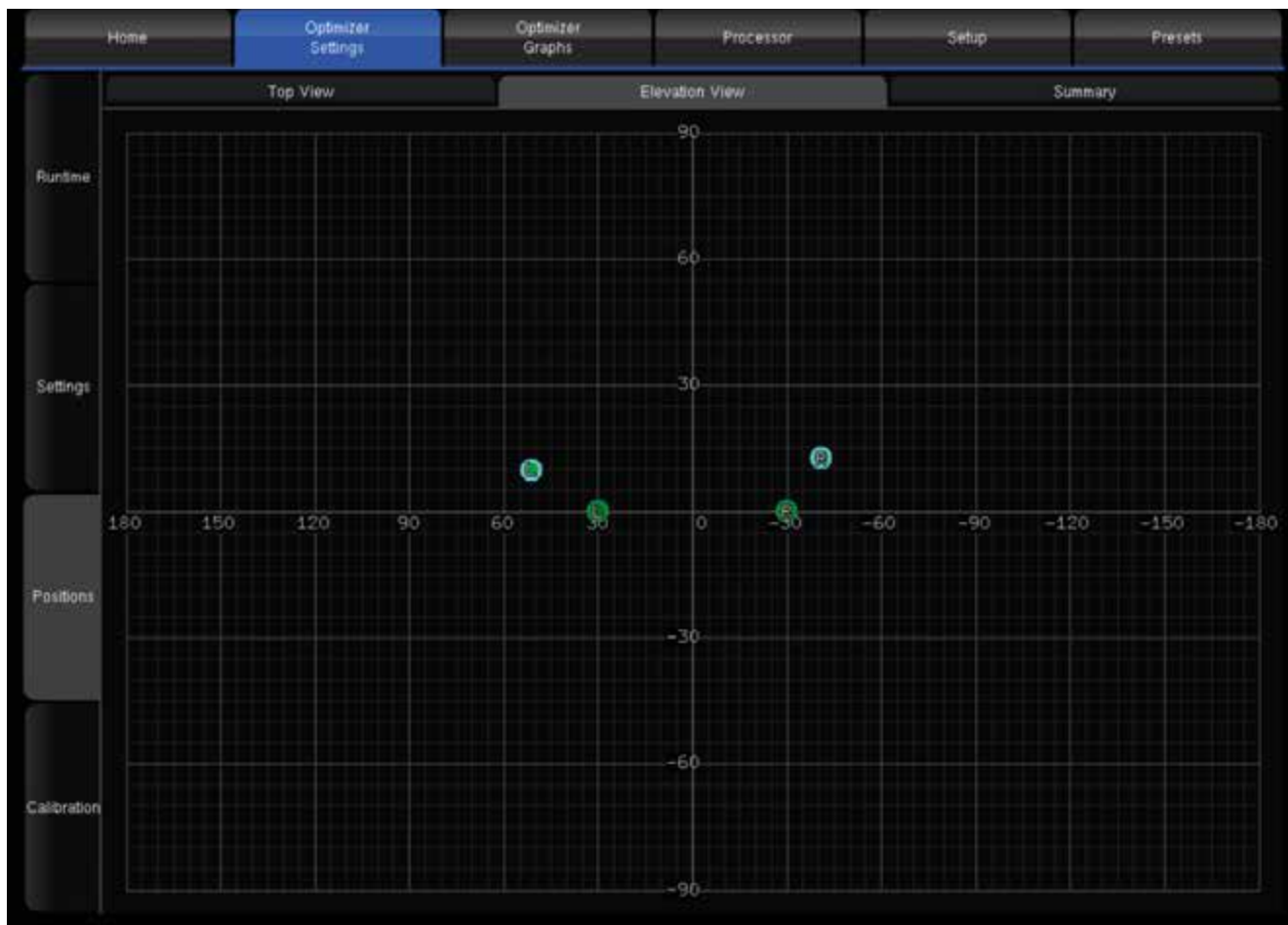

Figure 92: Elevation view of a system after calibration



NOTE:

- If one speaker cannot be located during calibration, it will be displayed in the center of the circle.
- A non located speaker cannot be used for loudspeaker remapping.

The **Summary** page provides additional measurements for each speaker:

		Top View	Elevation View		Summary
Runtime	Speaker	L	R		
	Distance (m)	3.27	3.23		
	Elevation (°)	9.8	12.5		
Settings	Azimuth (°)	51.1	-41.0		
	Level A (dBFS)	-50.8	-49.5		
	Level C (dBSPL)	77.2	79.0		
Positions	Level A compensated (dBSPL)	76.0	75.5		
	Level C compensated (dBSPL)	77.3	76.9		
	Delay (ms)	9.54	9.42		
Calibration	BM Delay (ms)	0.00	0.00		
	Delay compensation (ms)	0.00	0.12		
	Crest factor (dB)	32.9	32.0		
	Bandwidth (Hz)	20.5 - 18.6k	20.5 - 18.6k		

Figure 93: Speaker measurements summary

Measurement details:

- **Distance** is the distance of the speaker (in meters) to the measurement point;
- **Elevation** is the elevation of the speaker (in degrees) to the measurement point;
- **Azimuth** is the azimuth of the speaker (in degrees) to the measurement point;
- **Level A** corresponds to the A-weighted level of the speaker;
- **Level C** corresponds to the C-weighted level of the speaker;
- **Delay** corresponds to the distance of the speaker;
- **Bandwidth** corresponds to the measured bandwidth of the speaker;

Correction details:

- **Level A Compensated** corresponds to the A-weighted compensated level of the speaker;
- **Level C Compensated** corresponds to the C-weighted compensated level of the speaker;
- **Delay Compensation** is the delay that is added to every speaker to time align the system;
- **BM Delay** may be added to the subwoofer to improve the crossover with the satellites. More rarely, if the subwoofer is further away, all the satellites are delayed;
- **Polarity** specifies whether the Optimization will invert the polarity of the speaker. Please note this is not the “measured polarity” of the speaker;
- **Crest Factor** helps to evaluate the quality of the measurement. It should be higher than 30dB. Low values could indicate background noise problems. It is lower for subwoofers;

# 7 \_GOING FURTHER

## 7.1 \_ESSENTIAL TOOLS AND SETTINGS

This chapter provides important information you need to know before you proceed with the manual setup procedure and the manual calibration process. It will also provide more information and settings about the Optimizer.

### 7.1.1 \_METERING THE INPUTS AND OUTPUTS

The Altitude<sup>32</sup> includes an extensive set of audio utilities to perform various tests and manual operations during the setup process.

To access the audio utilities:

- Click on the Gears button to the top menu to open the Advanced Settings interface.
- Go to the Processor tab of the graphical user interface.

The main page of the Processor tab displays the input and output meters and a set of lateral tabs: Input and Output levels can be monitored through the Processor/Meters page. Both the peak levels and the RMS levels are displayed:

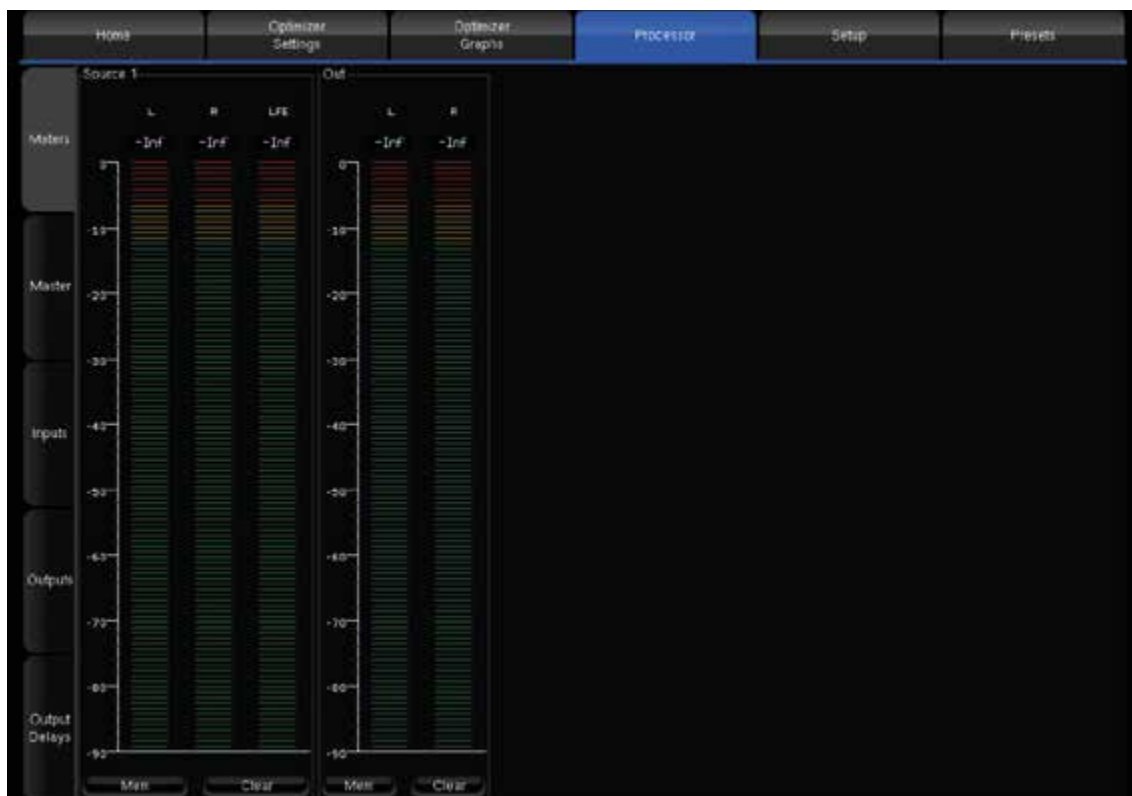

Figure 94: metering inputs and outputs

You can visualize the peak level of each channel. The highest level registered on each channel can be displayed by pressing the Mem button. When the level gets close enough to the saturation level, the name of the channel appears highlighted in red. The Clear button resets the memory and the saturation indicators for every channel of the group.



**IMPORTANT NOTE:** A digital signal cannot technically exceed 0 dBFS. Therefore, the red tag on top of each digital input channel only indicates when the maximum level of 0dBFS is reached and does not necessarily indicate distortion or clipping.

## 7.1.2\_PLAYING PINK NOISE ON THE SPEAKERS

**!** NOTE: To be able to produce pink noise, the Altitude<sup>32</sup> needs to have Word Clock synchronization. Be careful to use an analog source to be in master clock or that your digital device connected to the Altitude<sup>32</sup> and selected is providing a clock signal.

**Pink noise can be played:**

- From the Speakers/Room setup tool
- In the Advanced Settings interface, from the Processor/Inputs page

To play pink noise from the Speakers/Room setup tool, click on the Pink Noise button of the corresponding output channel:



Figure 95: playing Pink Noise from the Speakers/Room setup tool

The **Processor/Inputs** tab provides a complete set of processing options for each input channel. It allows you to send a 1000Hz sine wave or pink noise for every channel.

- To send a 1000Hz sine wave, click on the Sine button.
- To send pink noise, click on the Pink Noise button.

For instance, you can use Pink Noise for setting up your equalization as follows:

- In the Processor/Inputs page, press on the Pink Noise button for the channel you want to equalize,
- Switch to the Processor/Outputs page and open the Preset EQ or User EQ for that same channel,
- Make your EQ adjustments



Figure 96: Sine and Pink Noise buttons in the Inputs page of the Processor menu

### 7.1.3 \_SOLO/MUTE AN INPUT OR AN OUTPUT

The Inputs page and the Outputs page include Mute and Solo buttons that allow you to mute or solo any input or output channels at any time.

To Mute/Solo an input channel, go to the Inputs tab and click on the Mute/Solo button of the corresponding input channel:



Figure 97: Mute and Solo buttons in the Inputs page of the Processor menu

## 7.1.4 \_INPUT AND OUTPUT VOLUME

### \_7.1.4.1 \_INPUT VOLUME

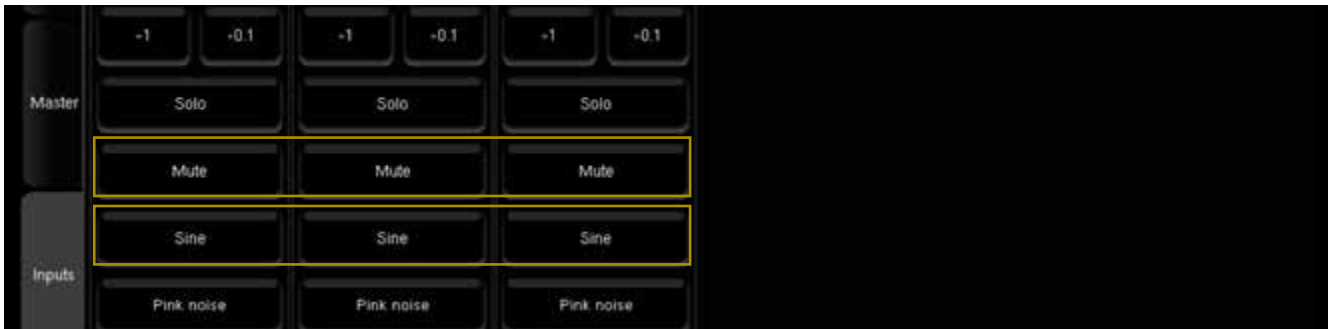

Figure 98: Mute and Solo buttons in the Inputs page of the Processor menu

In the menu Processor/Inputs, you can increase or decrease the Input volume of each channel by steps of 1dB or 0.1dB. Those settings are offsets the current calibration of the Optimizer. This might affect your system by making it unstable. We recommend leaving the Input Volume at 0.0.

### \_7.1.4.2 \_OUTPUT VOLUME

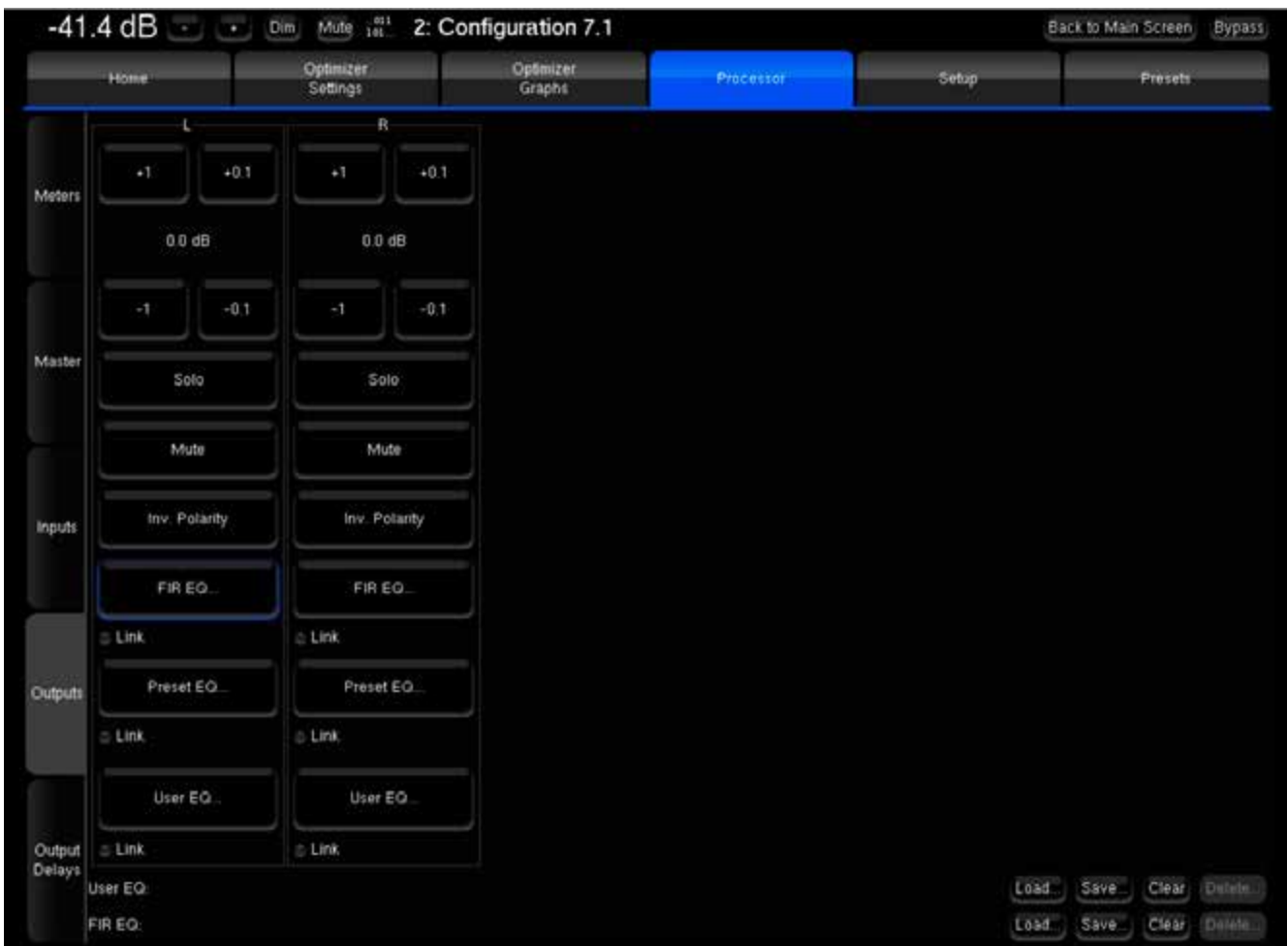

Figure 99: Outputs settings in the Outputs page of the Processor menu

In the menu Processor/Output, you can increase or decrease the output volume of each speaker by steps of 1dB or 0.1dB. Those settings are offsets from the current calibration of the Optimizer. This might affect your system by making it unstable. We recommend leaving the Output



The Outputs section also allows you to invert the polarity of each speaker.

### 7.1.5 \_EQUALIZATION

The Altitude<sup>32</sup> allows you to set some equalization on any speaker of your configuration. Please, remember that this option is for experts only. Changing the equalization of the speaker(s) can deteriorate the calibration done by the Optimizer. You can choose to add FIR EQ or Preset EQ. Both equalizations can't be used at the same time.

#### \_7.1.5.1 \_FIR EQ

The Altitude<sup>32</sup> allows you to add a FIR equalization on any speaker of your configuration.

With FIR equalization you can editing relatively to the frequency:

- The amplitude (dB).
- The group delay (ms).
- The phase (°).



Figure 100: FIR EQ settings in the Outputs page of the Processor menu

The FIR EQ's are available in the menu Processor/Outputs.

You can link several speakers. Every FIR EQ set to one speaker will automatically be applied to the other speaker linked.

For every speaker in the room, a FIR EQ can be defined in terms of:

- Amplitude only (dB)

- Amplitude and Group Delay (ms)
- Amplitude and Phase (°)

One or more channels can be linked in order to apply the same FIR EQ to several speakers.

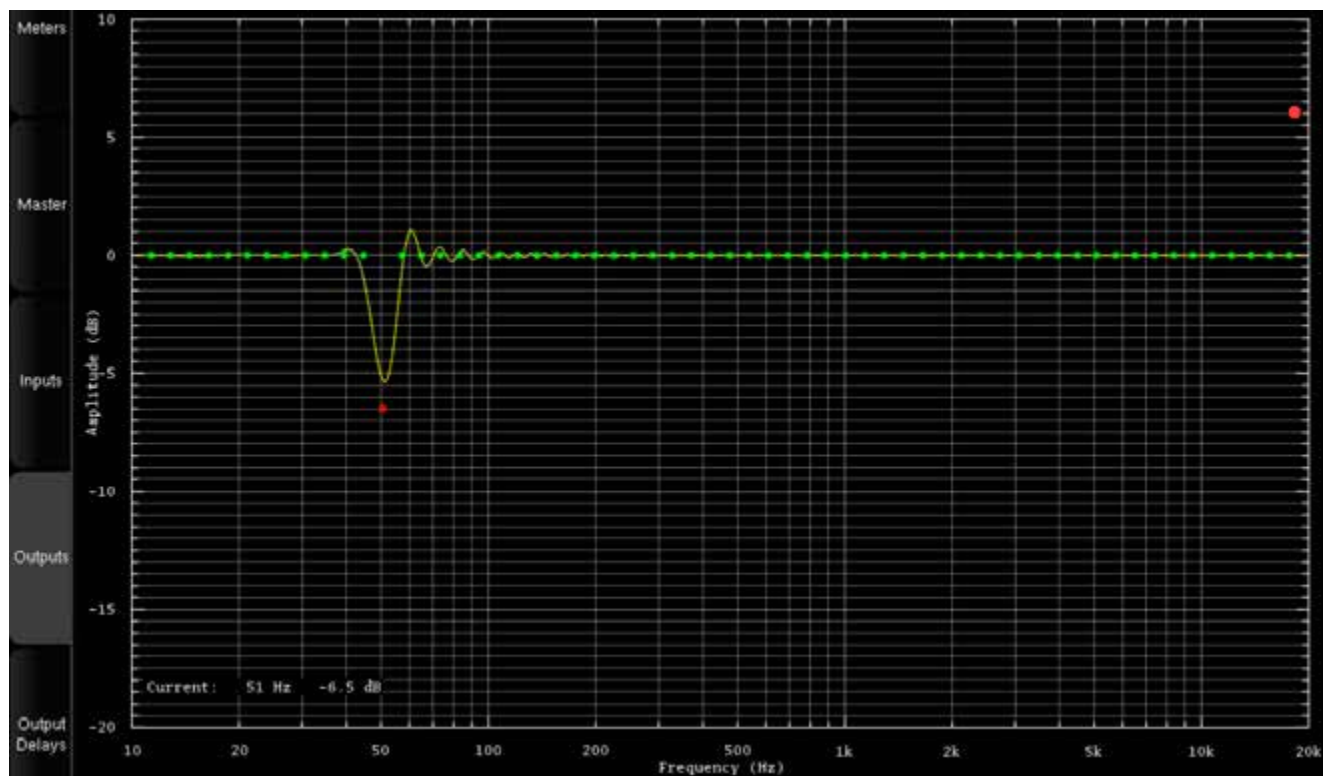

Figure 101: FIR EQ amplitude

The required curve can easily be edited via the touch screen or with the arrows of the keyboard:

- The green dots correspond to the required values for each frequency,
- The yellow line displays the expected result, taking into account the behavior of the filter.

The FIR EQ will be saved and reloaded with the whole Preset, through the usual Presets page. Press the Close button to apply the changes and get back to the Processor/Outputs tab.



NOTE: by default, since the length of the FIR filter is 100ms (as defined in the Advanced Settings), the FIR Equalizer has a constant resolution of 50Hz. This implies that it has very low resolution at low frequencies; it should therefore not be used to work on specific frequencies in the low range. Instead, it should be used to change the tonal balance as a whole.



IMPORTANT NOTE: Please keep in mind that the changes will not be applied until you press the OK button.

### \_7.1.5.2\_ 31 BAND GRAPHIC EQS

In addition to manually setting levels, the Processor/Inputs and the Processor/Outputs pages include 31-band, 1/3 octave Graphic Equalizers that allows manual equalization of each input or output channel:

- Input EQ is available on the input channels,
- Preset EQ and User EQ are available on the output channels

The Input EQ behaves exactly in the same way as the Preset EQ described below. The only difference is that it is applied to the inputs instead of the outputs.

The “Preset EQ” and “User EQ” buttons in the Processor/Output page give access to two independent Graphic EQs. Both EQs have the same interface (only the current EQ name at the bottom left of the window is added for the User EQ) but are saved in 2 different places.



Figure 102: Preset EQ

The Preset EQ will be saved and reloaded with the whole Preset, through the usual Presets page:

- Press Preset EQ, this shows the Graphic EQ for the selected channel,
- Move the faders to setup your equalization,
- Use the Previous/Next buttons to move to other channels,
- Press OK to come back to the Processor/Output page
- Go to Presets page to save these changes in a preset.

The modifications on these filters are applied in real time so you can hear them, but they are not visible on the frequency response curves in the Optimizer Graph page.

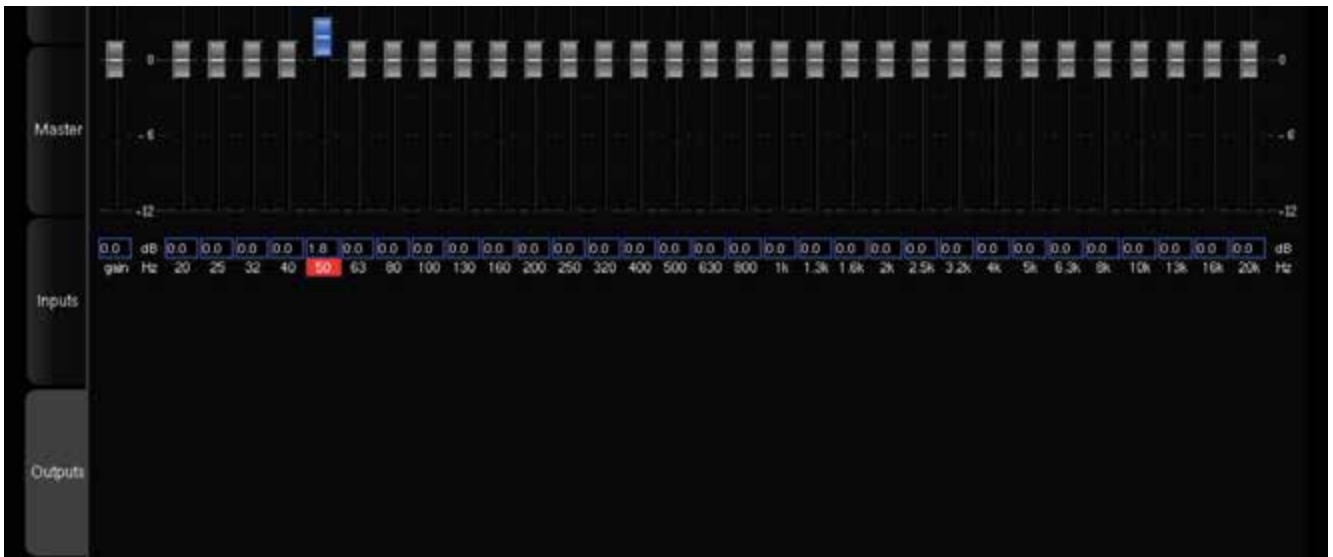

Figure 103: User EQ

Multiple User EQs can be saved and reloaded independently from the current preset:

- Press **User EQ**, this shows the EQ for the selected channel,
- Move the faders to setup your equalization,
- Use the **Previous/Next** buttons to move to other channels,

- Press **OK** to come back to the **Processor/Output** page,
- Press the **Save** button at the bottom-right to save this User EQ and give it a name using the virtual keyboard or a connected keyboard,
- You can now see the name of your new current User EQ at the bottom of the **Processor/Output** page.

This gives you the flexibility of having one “reference” EQ (User EQ) that can be used on top of Optimizer presets. As an example, User EQ could be recalled for a specific room. This also could be used as “User EQ” according to the user’s preference.

Notes - You can use Pink Noise for setting up your equalization, as follows:

- In the Processor/Inputs page, press on the Pink Noise button for the channel you want to equalize,
- Switch to the Processor/Outputs page and open the Preset EQ or User EQ for that same channel,
- Make your EQ adjustments,
- Use the Previous/Next buttons: the pink noise will follow to the same channel.

The pink noise will only follow if you start the EQ from the same channel where the pink noise has been activated. A typical use of this graphic EQ is ISO X curve compliance verification by a consultant or voluntary small change of the tonal balance.

## 7.1.6 \_OUTPUT DELAY

The Altitude<sup>32</sup> allows you to manually set the delay on each speaker. The delay can’t be negative.

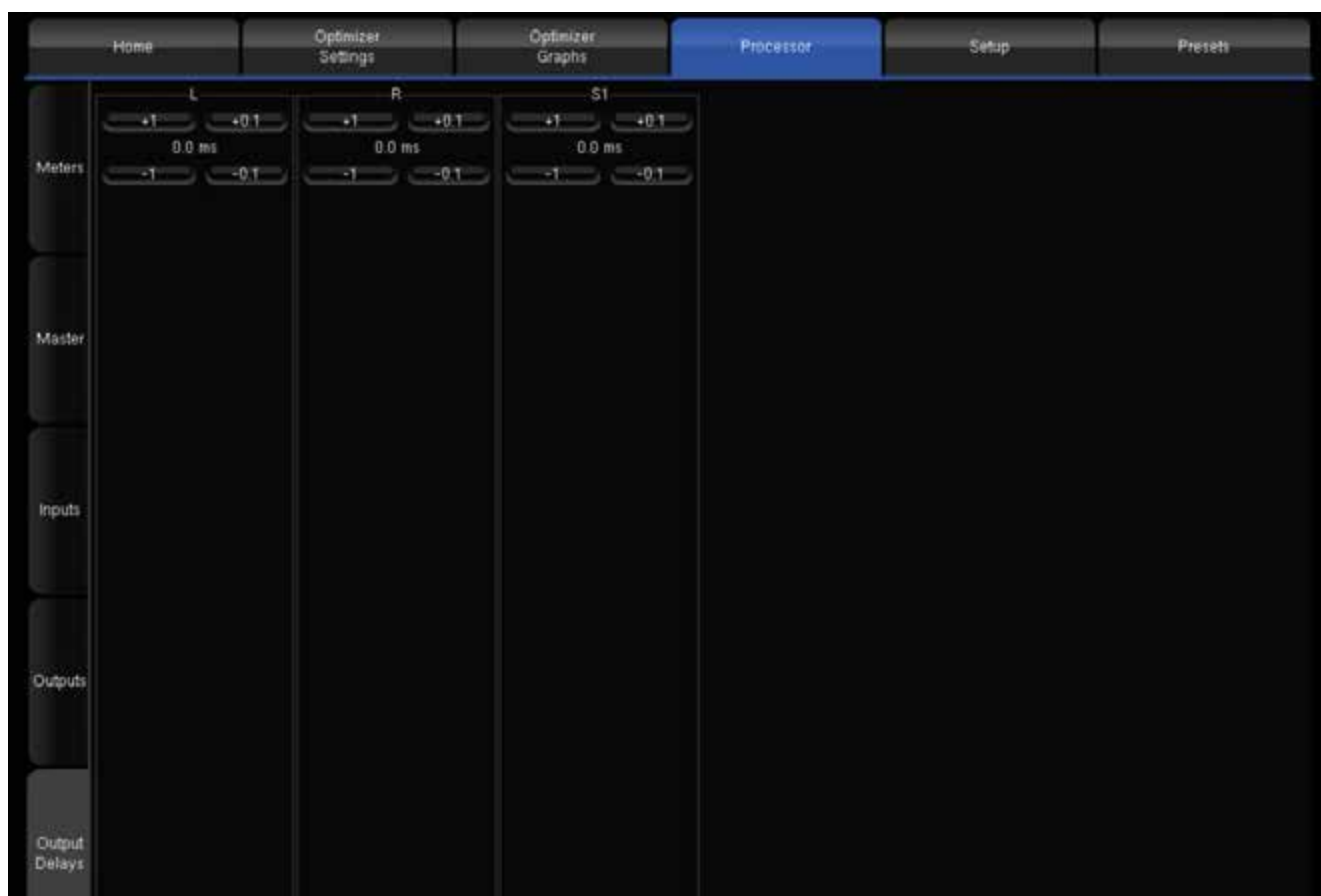

Figure 104: Output Delays settings in the Output Delays page of the Processor menu

In the menu Processor/Output Delays, you can increase or decrease the Output Delay of each speaker by steps of 1dB or 0.1dB.

Those settings will be added to the current calibration of the Optimizer. This might affect your system by making it unstable. We strongly recommend letting the Output Delay to 0.

## 7.1.7 \_SWITCHING OPTIMIZATION ON/OFF

The Altitude<sup>32</sup> offers two different ways to compare the sound of your system with or without optimization or selectively Acoustics Correction, Level Alignment, and Delay Alignment:

- The Bypass button, which is always visible at the top right corner of the Advanced Settings user interface.
- The Optimization On / Optimization Off buttons in the Optimizer Settings/Runtime page.

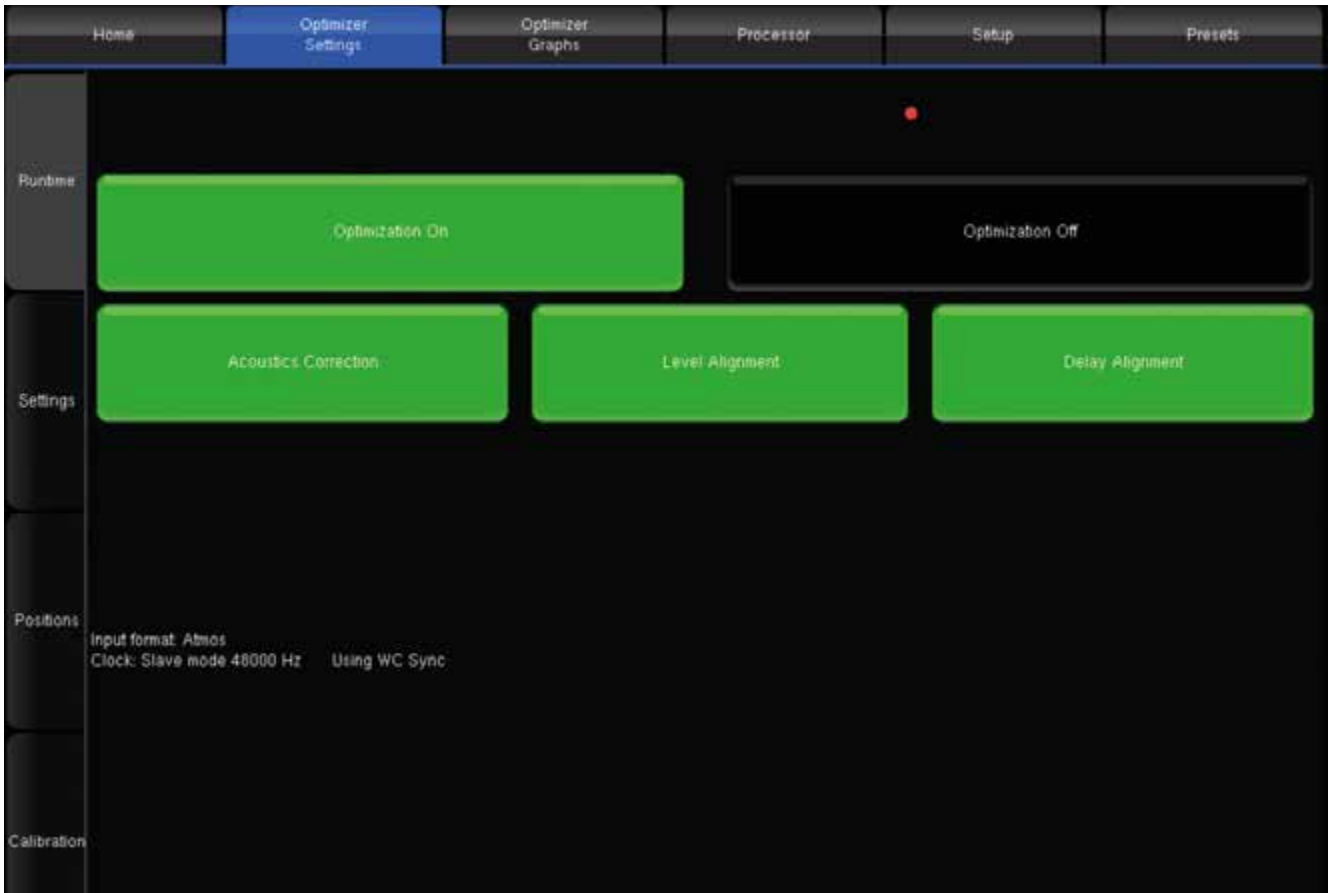

Figure 105: switching optimization on/off in the Advanced user interface

**Optimization On/Off buttons:** the buttons in the **Optimizer Settings/Runtime** page allow the user to selectively enable/disable the different corrections applied by the Optimizer.

These options are also available in the Main user interface in the Optimizer & Remapping page.

**Bypass button:** the bypass button located at the top right corner of the graphical user interface is equivalent to the **Optimization Off** button.



**IMPORTANT NOTE:** the Optimization On/Off and Bypass buttons disable the automatic compensation but manual corrections are still applied:

- FIR and Graphic EQs
- Input and output gains
- Outputs delays
- Bass Management
- Active Xovers

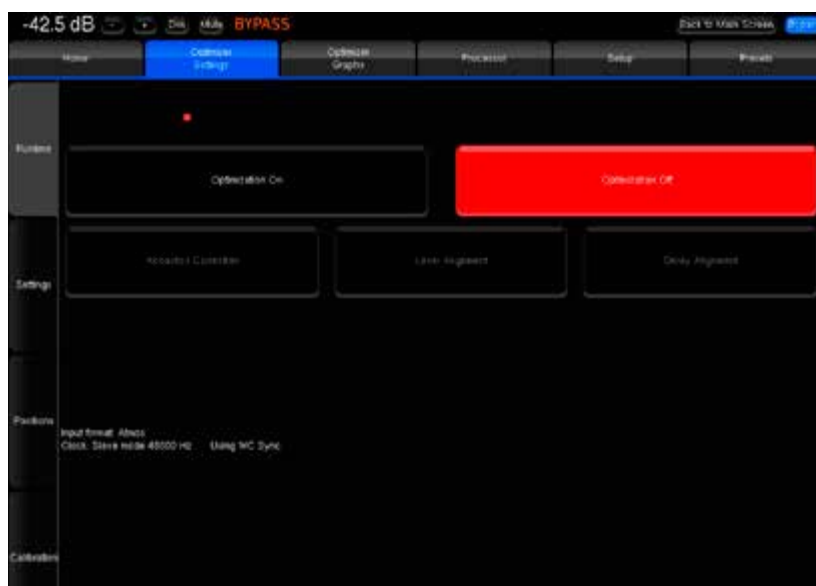

Figure 106: switching the optimization on/off in the Main user interface

## 7.1.8 \_MASTER CONFIGURATION

In the Processor/Master menu, you can set some parameters relative to the master of the unit.



Figure 107: Master levels and delays

The following options are offered in order to adjust levels and delays for all channels at the same time:

- **Master Level** is the reference level used by the processor for all presets. It affects both displayed and effective Level but it is not stored with presets.
- **Relative Level** may be used to match different presets subjective levels since it can be saved. Therefore you could for instance carry out proper A/B comparisons between different settings such as Optimization On/Off. It does not affect the displayed level (on the top left corner of the screen).
- **Level display offset:** its main use is to display the level in dB SPL you would measure in the room with a -20 dBFS pink noise feeding the outputs of the Optimizer with a 0dB master level (102,6 dB in our example). To do so, the system must have been calibrated and the dBC button selected. The Legacy option displays the level according to another cinema standard scale with values from 0 to 10. Level display offset affects displayed level only and has no impact on the level itself. It cannot be stored in presets. Without the dBC button pressed, it has the same features as Output SPL adjust except it cannot be saved. Once the dBC option activated, level adjustment is disabled.
- **Output SPL adjust** affects both displayed and effective Level. Used along with Level display offset, it allows you for instance

- to set a reference level corresponding to a measured 85 dB SPL and to store it into a preset. It is a typical cinema use.
- **Level offset when correction is On:** this level offset will be applied when the Acoustic Correction is activated.
- **Level offset when remapping is On:** this level offset will be applied when 2D or 3D Remapping is activated.
- **Master Delay** can be used to apply an additional delay to all channels and all presets. It is not stored in the preset.
- **Relative Delay** can be used to modify the delay of a preset.

The following latency information is available:

- **Processing Latency** corresponds to the latency of the processor algorithms. It can be modified by changing the Optimize setting (Amplitude + Phase has higher latency than Amplitude only) or the Audio Buffer Size (in Setup/Clock Settings).
- **Master + Relative Delay** is the sum of the master and relative delays of the Processor/Master page.
- **In-out Delay** is the sum of the Processing Latency, the User-defined delays and DRC latency. For the furthest speaker, it corresponds to the system's delay from input to output.
- **Acoustic Delay** corresponds to the distance of the furthest speaker to the measurement point. When Time Alignment is activated, all the other speakers will be time-aligned to the furthest speaker.
- **Total delay at the measurement point** is the delay from one input until the sound reaches the measurement point.

**NOTE:** The Master Delay and Relative Delay can be a first approach of a sync lips. Indeed, you can set all the speakers to a value of delay so that the sound will be delayed compared to the video

### 7.1.9 \_AUDIO CLOCK SETTINGS

At various times during the setup procedure, you may need to check the status of the audio clock or to manually change its settings.

By default, the audio clock automatically switches to Slave mode when you select a digital source or Master mode when you select an analog source. However, during the calibration procedure, you will select the microphone inputs and will later switch to an HDMI source to verify the sound of the system.

At some point, the Altitude<sup>32</sup> may be set to slave mode but may not be receiving any clock information if the digital source is not connected. In this situation, the system is not able to produce sound, like pink noise or sine waves. If this happens to you, please set the clock to Master mode or simply switch to an analog input.

#### \_7.1.9.1 \_AUDIO CLOCK STATUS INFORMATION

The Word Clock page in the main window provides information about the status of the audio clock:

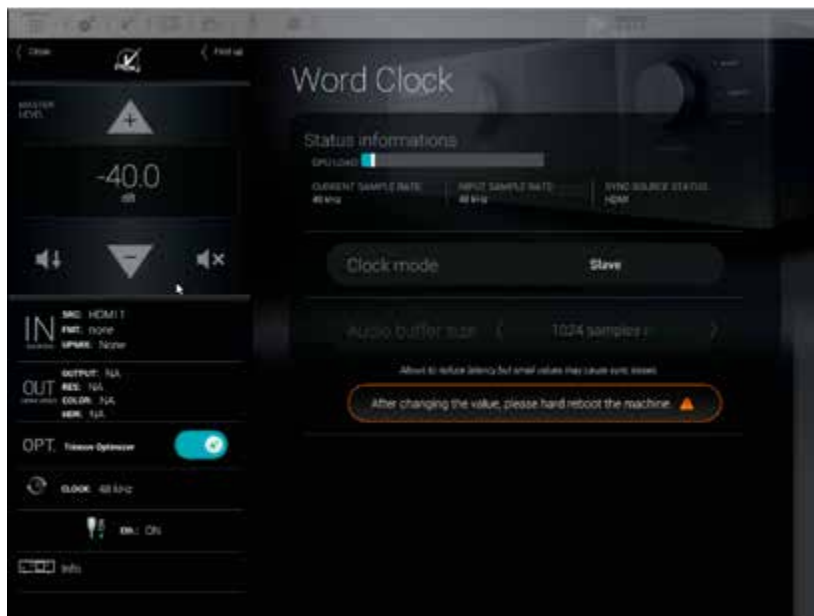

Figure 108: Audio clock status information

The information about the status of the audio clock includes:

- the clock mode: slave or master. This setting can be changed in the Setup/Clock page of the Advanced Settings interface (see below).
- the current sample rate: the sample rate currently used by the Altitude<sup>32</sup>. If the clock is in slave mode it corresponds to the input sample rate. If the clock is in master mode, it corresponds to the sample rate selected in the Setup/Clock page of the Advanced Settings interface.
- the input sample rate: the detected sample rate of the currently selected input.
- the current sync source: may be internal if the clock mode is set to master or related to the currently selected source.

### \_7.1.9.2 \_AUDIO CLOCK SETUP

Audio clock setup is available through the Advanced Settings interface of the Altitude<sup>32</sup>.

To access the clock settings page:

- Click on the Gears button to the top menu to open the Advanced Settings user interface.
- Go to the **Setup/Clock** tab of the graphical user interface.

The **Clock** page of the **Setup** tab includes all the clock settings:

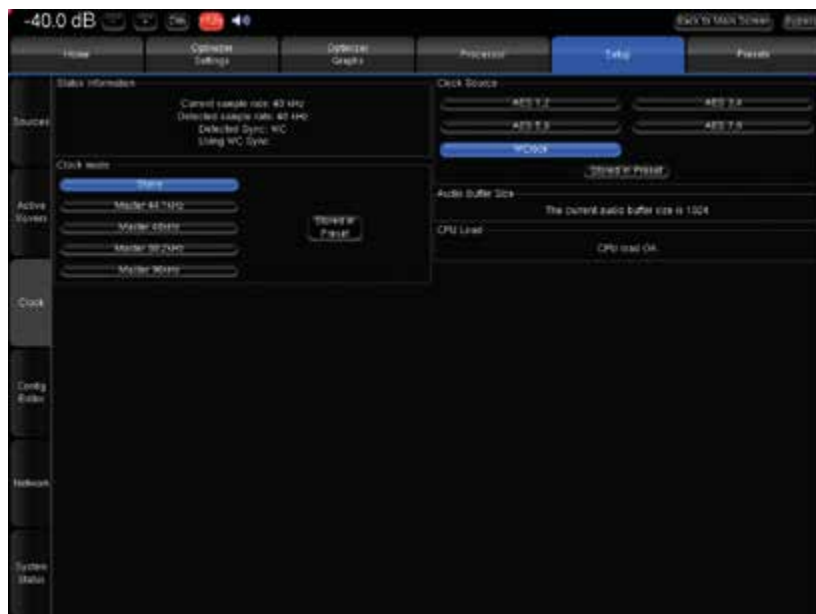

Figure 109: Clock settings page in the Advanced Settings

The **Setup/Clock** page includes:

**Status Information:** the same information provided in the Clock page of the main user interface.

**Clock Mode:** slave or master modes.

**Clock Source:** one of the digital inputs or the internal Word Clock of the Altitude<sup>32</sup>.

**Audio Buffer Size:** different buffer sizes used to reduce latency. Only recommended for advanced users.

## 7.2 \_MAIN OPTIMIZATION SETTINGS

The Optimizer Main Settings are located in the Optimizer Settings/Settings/Main Settings page.



NOTE: Changes made in the Optimizer Settings do not require new acoustic measurements. The new compensation filters are recomputed on the fly using the Apply changes button.



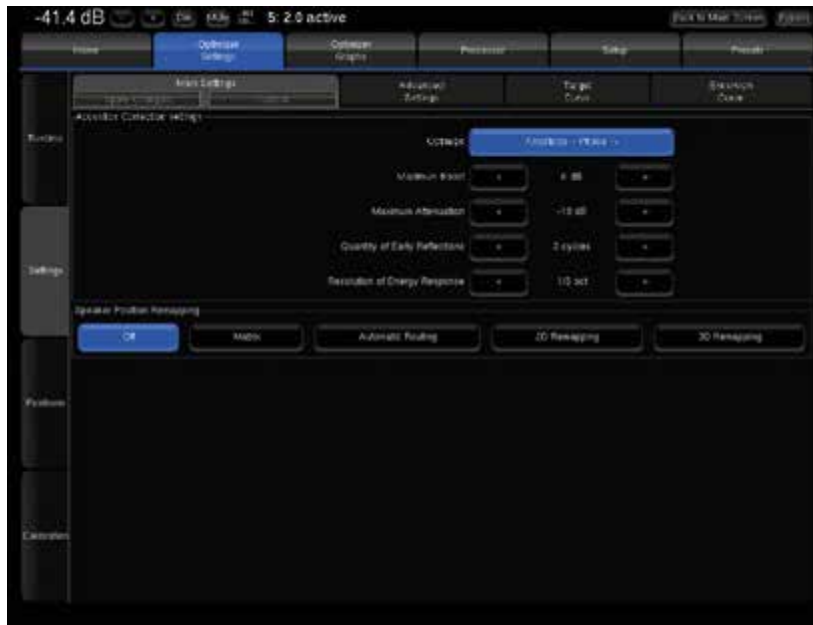

Figure 110: Main optimization settings

**Optimize (Optimization Modes):** The Altitude<sup>32</sup> offers four different optimization modes with very specific behavior:

- **Amplitude + Phase (default):** With this setting, the Optimizer will improve both the loudspeaker amplitude and the phase response of the loudspeaker. This greatly reduces the group delay of the speakers starting from about 150Hz.
- **Amplitude only:** This mode tells the Optimizer to work only on the amplitude of the loudspeaker's response. The phase behavior is not modified;
- **Low range only:** With this setting the automatic equalization will only use IIR filters up to the frequency defined in the advanced settings (Default: 150Hz). The automatic FIR filter is disabled but manual FIR EQ can still be applied;
- **According to L&R speakers:** This is a special mode that will optimize the other speakers in order to achieve the same response as the averaged Left+Right speakers. The different options available for this mode are explained in the Advanced Optimization Settings subchapter.

**Maximum Boost/Attenuation:**

- **Maximum boost:** defines, in dB, the maximum amount of boost that will be performed by the algorithms. This parameter is used to avoid distortion. Its default value is 6dB. This parameter has an important impact on the behavior of the automatic equalization, and is applied to both the time-based and the amplitude-based approach.

See also the Limiter Curve functionality described below.

• Acoustic parameters “Quantity of Early Reflections” and “Resolution of Energy Response”:  
The Altitude<sup>32</sup> uses two different approaches for the Optimization of Loudspeaker/Room Acoustics:

1. A time-based approach for the correction of Early Reflections (ER). The main parameter that defines the behavior of this algorithm is the width of the time-frequency window “**Quantity of Early Reflections**”.

**Quantity of Early Reflections** (default is 3 cycles): A simple parameter that characterizes the quantity of early reflections that the Optimizer tries to compensate is the width of the time-frequency window. The size of this window is defined by a number of cycles, hence the naming “ $\alpha/f$ ”, where  $\alpha$  (alpha) is the number of cycles and  $f$  the frequency (1/ $f$  being one cycle). The meaning of the time-frequency window is as follows: for each frequency a different duration (or width of the time window) is taken into account. At low frequencies, the window typically starts at 150ms for 20Hz, and constantly decreases to be as low as 0.3ms at 10 kHz.

2. An amplitude-based approach for the correction of Late Reverberation (LR), whose main parameter, **Resolution of Energy Response** is the smoothing applied to the energy response.

**Resolution of Energy Response** (default is 1/3 octave): It defines, in number of octaves, how the room energy response is smoothed, and modifies the behavior of the equalization performed by the Optimizer on the Late Reverberation. Its default value is 1/3 octave.

The behavior of the energy optimization algorithm varies according to the smoothing applied to the room's response. If the response is less smoothed, sharp peaks in the response will be more taken into account for the correction while, with more smoothing only, the overall tonal balance of the room will be corrected.

## 7.3 \_TARGET CURVE

The Altitude<sup>32</sup> implements Target Curves as a powerful tool for achieving the required frequency response from your system. For every speaker in the room, a target curve can be defined in terms of:

**Amplitude only / Amplitude and Phase / Amplitude and Group Delay**

One or more channels can be linked to share the same target curve for several speakers.

### 7.3.1 \_OVERVIEW OF THIS PROCEDURE

In the Altitude<sup>32</sup>, setting target curves is a very straightforward procedure:

- Decide if you want to apply the same target curve to all the speakers (except subwoofers) or if you want to apply a different target curve depending on the type of speaker.
- Link/unlink the speakers that will share the same target curve.
- Setup the target curve for each group of speakers.
- Press the Apply Change button.

### 7.3.2 \_SETTING UP ONE OR MORE TARGET CURVES

To edit the target curve for one or more speakers, go to the Optimizer Settings/Target Curve page in the Advanced Settings user interface:

The most usual case is to link all the speakers except the subwoofer(s). Therefore, by default, the Link button is activated for all the speakers except for the subwoofer(s). If this is not the case, you can press the Link all but Sub button. Use the arrow keys of your keyboard or your mouse to edit the target curve:

- The green dots correspond to the required values for each frequency,
- The yellow line displays the expected result, taking into account the behavior of the filter.

Press the Apply Changes button. This button becomes orange as soon as you change some setting that requires a new computation of the optimization filters.

Save a new preset. This will allow you to compare the sound with and without the target curve. You can save target curves and load their onto different presets.



Figure 111: Example of a Target Curve in the Advanced Settings user interface



## NOTE:

- By default, the Optimizer will use both IIR and FIR filters to achieve the target curve.
- In addition to target curves, several other parameters define the behavior of the automatic

### 7.3.3 \_SAVE / LOAD TARGET CURVE

Altitude<sup>32</sup> users are now able to save their Target Curves and load them onto different presets.

Every system is different and the subsequent Target Curve that enables calibrators to achieve optimal results, therefore, cannot always be the same. This is why the default Target Curve in the Optimizer is set to flat, as an arbitrary starting point rather than a recommendation. However, a different starting point can save some time since a Target Curve will almost always consist of the following:

- A certain amount of boost in the low frequency
- Some roll-off in the high-frequency
- Possibly a slight dip in the high-mids



This effectively replaces the manual edit and behaves the same way. In other words, the Target Curve is independent of speaker layouts and will be loaded/applied to whatever speakers are linked in the Target Curve menu when loading the Target Curve file.

## 7.4 \_LIMITER CURVE

Unlike the **Maximum Boost/Attenuation** parameters, the limiter curve allows to setup frequency-dependent maximum boosts and attenuations. This curve is not engaged by default.

To define a specific limiter curve, go to **Optimizer Settings/Settings/Excursion Curve**:

- Use the Add point mode and your mouse to create editing points around the required frequency range.
- Use the Move point mode and your mouse to edit the limiter curve for the required frequency range.

Use the Delete point mode to delete editing points with your mouse.



IMPORTANT NOTE: Smooth transitions sounds preferred.



NOTE: Editing the maximum boost and maximum attenuation limiter curve disables the global Maximum Boost/Attenuation settings in the Optimizer Main Settings page.



Figure 112: example of a limiter curve for maximum boost/attenuation

## 7.5 \_ADVANCED OPTIMIZATION SETTINGS

**!** IMPORTANT NOTE: Change these parameters from the recommended settings only if you know what you're doing. Random changes can lead to unexpected results.

The Altitude<sup>32</sup> provides a large set of advanced settings in the Optimizer Settings/Settings/Advanced Settings page:

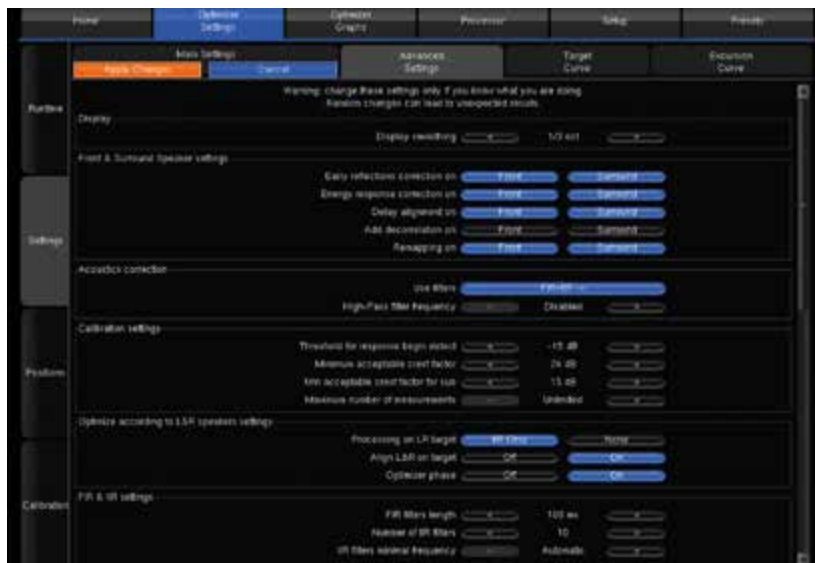

Figure 113: Advanced optimization settings

### 7.5.1 \_DISPLAY

The Display smoothing defines the smoothing value used to display the before and after Amplitude Response in the Optimizer Graphs as well as in the pdf document generated while saving a preset. Its default value is (1/3 octave). A smaller value, such as 1/12 octave, can be used to display more details in the frequency response.

### 7.5.2 \_FRONT & SURROUND SPEAKER SETTINGS

The following features can be separately enabled/disabled for the front speakers and for the surround speakers:

Early reflections correction;

- **Energy response correction;**
- **Delay alignment,** e.g. surround delay alignment may or may not be required depending on the application and recommendations;
- **Add decorrelation:** the Optimizer can apply a decorrelation algorithm to the surround channels to replicate the diffuse field created by a belt of surround speakers;
- **Remapping:** To create an array of speaker with the same channels and amplifiers, the remapping won't be the best solution.



NOTE: Front speakers are defined as those whose azimuth is below 90 degrees. Conversely, Surround speakers are defined as those whose azimuth is above 90 degrees.

### 7.5.3 \_ACOUSTICS CORRECTION

The user can determine the type of filters for the automatic correction:

- **FIR + IIR:** This is the default setting used by the Optimizer: Both IIR and FIR filters are used to work on the speaker responses full range;
- **FIR only:** No IIR filters are used, which means that the Optimizer will only work on the mid and high range of the speaker responses. The low range will not be optimized;
- **IIR only:** With this setting, both the automatic FIR and the FIR EQ are disabled. The Optimizer will only use IIR filters to work on the low range. This setting could be used in specific cases where the user wants to be sure that no FIR filters at all are applied.
- **High-pass filter frequency:** Defines the cutoff frequency for the high-pass filter applied to all channels. Can be disabled.

### 7.5.4 \_CALIBRATION SETTINGS

- **Threshold for response begins detect:** The threshold below the peak level of the impulse that is taken into consideration to determine the onset of the response. -15 dB is the default value and works in most cases. However, a lower threshold is recommended in a room with a unusually large amount of early reflections where the peak might not be detected correctly.
- **Minimum acceptable crest factor**
- **Minimum acceptable crest for sub**
- **Maximum number of measurements**

### 7.5.5 \_OPTIMIZE ACCORDING TO L&R SPEAKERS SETTINGS

The Optimize mode "According to L&R speakers" can be configured with specific settings:

- **Processing on L&R target (Default is IIR only):** If the optimize mode is set to "Optimize according to L&R speakers" in the main settings tab, the Optimizer only uses IIR filters on the L&R speakers. This can be switched to "None" to make sure the L&R speakers are not optimized at all.
- **Align L&R on target (Default is On):** If this setting is on, the Optimizer applies filters on the Left & Right speakers using their average response as target. If this setting is off, only the center and surround channels are optimized.
- **Optimizer Phase (Default is On):** Determines whether the Optimizer should optimize the phase response of the speakers or not when the According to L&R speakers mode is on.

## 7.5.6 \_FIR AND IIR SETTINGS

FIR stands for Finite Impulse Response. FIR filters are used to optimize amplitude and/or phase. IIR stands for Infinite Impulse Response. IIR filters are minimum phase filters used by the automatic compensation in addition to FIR for the low frequencies.

- **FIR filter length** (default is 100ms): Defines the length or number of taps of the FIR filter. The longer the FIR filter, the higher the resolution the correction.
- **Number of IIR filters** (default is 10): The number of IIR filters that will be used on every channel.
- **IIR filters minimal/maximal frequency** (default is Automatic/150Hz): IIR filters will be positioned from the min frequency up to the max frequency. The Automatic parameter uses the minimum frequency of the speaker bandwidth and the Low-freq auto transition bandwidth parameter to calculate the IIR filter minimal frequency.
- **Resolution of energy response for IIR:** you can select a different resolution for IIR and FIR. The Optimizer uses a combination of FIR and IIR filters to achieve the best possible result in terms of time and frequency corrections. This parameter affected both the resolution of FIR and IIR filters across the bandwidth (default 1/3rd octave). Calibrators benefit from a dedicated parameter to define the resolution of the energy response for the IIR filter, independently from the FIR filter. As a result, IIR optimization (below 150Hz by default) can further improve bass response without affecting the FIR behavior.
- **Low-freq auto transition bandwidth** (default is 1 octave): Determines the bandwidth of the auto transition. The auto transition is the frequency range that separates the Optimized frequency range from the unfiltered frequency range in the low end. The upper boundary of this auto transition bandwidth is the minimal frequency of the bandwidth of the speaker.
- **Room smoothing method** (default is Modulus): For advanced users only.
- **Norm used for level\_hp (!= align)** (default is Room): For advanced users only.

## 7.5.7 \_LEVEL ALIGNMENT SETTINGS

- **Weighting used for levels** (default is dBA): Sets the type of weighting used by the optimizer for level alignment.
- **Width of level window** (default is 16/f): This time-frequency window is used to compute the perceptual level of every speaker. Its width can be modified to improve the automatic level alignment.
- **Maximum/minimum gain on speakers** (default is 10dB/-20dB): defines the maximum/minimum gain that will be applied for the automatic level alignment.
- **Minimal/maximal bandwidth frequency** (default is 10Hz/Unlimited): defines the high end/ low end of the bandwidth that is used as the starting point for level computations.
- **Bandwidth determination mode** (default is Normal): Defines the speakers automatic bandwidth determination mode from measurements.

## 7.5.8 \_SUBWOOFER LOW-PASS FILTER SETTINGS

The Optimizer includes a subwoofer low-pass filter with the following options:

- **Cutoff frequency** (Default is “disabled”): Defines the cutoff frequency for the low-pass filter that can be applied to the subwoofer.
- **Filter type** (Default is Butterworth): Defines the type of filter used at the cutoff frequency. The elliptic filter is sharper than the Butterworth but shows ripples in the whole bandwidth.
- **Filter order** (Default is 4): Defines the steepness of the filter. The slope gets stiffer as you increase the filter order. Please be aware that such changes may result in significant phase shifts.
- **Rp value** (For elliptical filter) (default is 0.1 dB): Sets a maximum amplitude ripple above the cutoff frequency.
- **Rs value** (For elliptical filter) (default is 80 dB): Defines the attenuation below the cutoff frequency.

## 7.5.9 \_DECIMATION SETTINGS & ADVANCED FIR SETTINGS



IMPORTANT NOTE: It is strongly recommended not to change these settings unless you have been requested to do so by your Trinnov Distributor.

## 7.5.10 \_ADVANCED FIR SETTINGS



IMPORTANT NOTE: It is strongly recommended not to change these settings unless you have been requested to do so by your Trinnov Distributor.

# 8 \_DECODER / UPMIXER SETTINGS

The Altitude<sup>32</sup> allows you to enjoy various kinds of surround and stereo playback modes using the decoders mentioned below. With the 3D codecs option, you are also able to extend your stereo or basic multichannel content (5.1/7.1) to a full 3D sound, and so use most of the speakers specified in the setup procedure. These are the Upmixers:

## 8.1 \_SUPPORTED DECODERS/UPMIXERS

A number of surround and 3D codec decoders are implemented in the Altitude<sup>32</sup>:

•Dolby decoders  
•(available as a standard feature  
•of the Altitude<sup>32</sup>):

- Dolby Digital
- Dolby Digital Plus
- Dolby TrueHD



•DTS decoders  
•(available as a standard feature  
•of the Altitude<sup>32</sup>):

- DTS Digital Surround
- DTS-HD High Resolution Audio
- DTS-HD Master Audio



•3D decoders  
•(ONLY available with the 3D option  
•for the Altitude<sup>32</sup>):

- Dolby Atmos
- DTS:X
- Auro-3D



With the 3D option, the Altitude<sup>32</sup> also supports the following surround Upmixers:

Dolby Surround®

DTS Neural:X®

Auro-Matic®

**!** NOTE: Some speakers are not utilized by every decoder. In this case, they will remain silent while this decoder is active. For example, the "Top" speaker is not used by Dolby Atmos, so this speaker will only be used while playing DTS:X and Auro-3D content, and also if you use their respective upmixer.

## 8.2 \_LISTENING FORMATS

The Listening Format dropdown menu provides you several options. Some of them may sound familiar to you, and the others could be unknown. The list gives you:

- **Auto:** The incoming encoded content will be played with the corresponding upmixer.
- **Dolby Surround:** The incoming content will be played using the Dolby Surround upmixer.
- **Neural:X:** The incoming content will be played using the DTS Neural:X upmixer.
- **Auro-3D:** The incoming content will be played using the Auro-3D upmixer.
- **Native:** The incoming content won't be modified and will be played as it is.
- **Upmix on Native:** The incoming content will be played using the corresponding upmixer : with the Legacy speaker layout (Dolby or DTS column).
- **Legacy:** This listening format will only play the “bed” layout of the content (5.1 or 7.1) and will ignore the 3D layout.

**Custom:** You are not able to select this mode manually but it is automatically selected as soon as you change any of the decoder's settings.



NOTE: Depending of the incoming format decoded by the Altitude<sup>32</sup>, the listening format listed above will exhibit different behaviors. Please read the chart below carefully, which indicates the behavior of each listening format relative to the source format.

SOURCE FORMAT	PCM	DOLBY (DD, DD+, TRUEHD)	NATIVE DOLBY ATMOS	DTS (LEGACY, HD MASTER AUDIO)	DTS:X	NATIVE AURO-3D*
<b>AUTO</b>	•None (No Upmix)   Layout used: selected in Decoder General setting	•Dolby Surround Upmixer   Layout Used: Atmos	•Native Dolby Atmos   Layout Used: Atmos	•Neural:X Upmixer   Layout Used: DTS:X	•Native DTS:X   Layout Used: DTS:X	•Native Auro-3D (3)   Layout Used: Auro-3D
<b>DOLBY SURROUND</b>	•Dolby Surround Upmixer (1)   •Layout Used: Atmos	•Dolby Surround Upmixer   Layout Used: Atmos	•Native Dolby Atmos   Layout Used: Atmos	•Dolby Surround Upmixer   Layout Used: Atmos	•Native DTS:X   Layout Used: DTS:X	•Dolby Surround Upmixer   Layout Used: Atmos
<b>NEURAL:X</b>	•Auro-3D Upmixer (1)   Layout Used: Auro-3D	•Auro-3D Upmixer   Layout Used: Auro-3D	•Native Dolby Atmos   Layout Used: Atmos	•Auro-3D Upmixer   Layout Used: Auro-3D	•Native DTS:X   Layout Used: DTS:X	•Native Auro-3D*   Layout Used: Auro-3D
<b>AURO-3D</b>	•None (No Upmix)   Layout used: selected in Decoder General settings	•None (No Upmix)   Layout Used: Dolby	•Native Dolby Atmos   Layout Used: Atmos	•Neural:X Upmixer   Layout Used: DTS	•Native DTS:X   Layout Used: DTS:X	•Native Auro-3D*   Layout Used: Auro-3D
<b>NATIVE</b>	•None (No Upmix)   Layout used: selected in Decoder General settings	•None (No Upmix)   Layout Used: Dolby	•Bed (Original 7.1)   Layout Used: Dolby	•None (No Upmix) (2)   Layout Used: DTS	•Bed (Original 7.1)   Layout Used: DTS	•Bed (Original 7.1)   Layout Used: Auro-3D
<b>UPMIX ON NATIVE</b>	•Upmix following the default PCM layout in the Decoder General settings	•Dolby Surround Upmixer   Layout Used: Dolby	•Native Dolby Atmos   Layout Used: Atmos	•Neural:X Upmixer   Layout Used: DTS	•Native DTS:X   Layout Used: DTS:X	•Native Auro-3D*   Layout Used: Auro-3D
<b>LEGACY</b>	•None (No Upmix)   Layout used: selected in Decoder General settings	•None (No Upmix)   Layout Used: Dolby	•Bed (Original 7.1)   Layout Used: Dolby	•None (No Upmix) (2)   Layout Used : DTS	•Bed (Original 7.1)   Layout Used: DTS	•Bed (Original 7.1)   Layout Used: Auro-3D

Figure 114: Chart of the behavior between source format and listening mode



## \_KNOWN ISSUES

(1) *Potential issue with stereo PCM sources (typically CD): the HDMI outputs of some Blu-Ray players declare 7.1 channels instead of 2. In such case, surround and rear channels will not be upmixed. This issue comes from the player, not from the Altitude<sup>32</sup>. The only solution is to force the player to deliver 2 channels.*

(2) *Potential issue with 7.1 material: with the Legacy Upmix mode, the "channel remapping" option of the DTS decoder is set to "off". The Ls and Rs channels may be missing as the decoder may expect Lss and Rss channels. The best solution is to set the "channel remapping" to "auto" or to use the Native listening mode.*

(3) *Potential issue with Auro-3D content: Auro-3D may not be detected in Listening Format Auto. In such cases, the upmixer of the Bed format will be used. If it is Auto-3D PCM material, the upmixer used will depend on the PCM default layout selected in the Decoders General Settings. If this happens, selecting Auro-3D listening format will play Native Auro-3D content.*

**CPU LOAD:** Do not forget that upmixers require a lot of CPU resources, especially in 96 kHz with high channel count. Until further software optimization is achieved, please contact Trinnov Audio to set less demanding Loudspeaker/Room optimization parameters.

**Auro-Matic:** the Auro-3D upmixer does operate up to 96 kHz but not with higher sampling rates.

**Neural:X:** The Neural:X upmixer does operate up to 48 kHz but not with higher sampling rates.

\* Please refer to the important note below.

For detailed information about the surround upmixers, please contact Trinnov Support team.



IMPORTANT NOTE: Sometimes, in Auto or Native listening format, Auro-3D content may not be correctly detected and decoded at the input. In this situation, only 5.1 or 7.1 content will be considered. If so, please set the Listening Format on Auro-3D to ensure the complete Auro-3D decoding. This behavior will be solved in a future software release.

## 8.3 \_USING THE FRONT PANEL

### 8.3.1 \_LISTENING FORMAT SELECTION

From the front panel of the Altitude<sup>32</sup>, press the **Menu** button. Use the **Select** knob, navigate to the “**Listening Format**” menu. Validate using the **Enter** button.

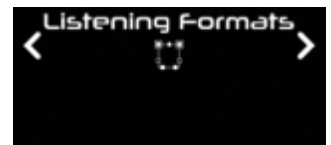

Choose the desired listening format using the **Select** knob. Validate using the **Enter** button. The current listening format is underlined.

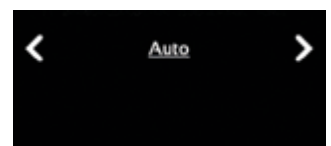

## 8.3.2 \_DECODERS CONFIGURATION

To configure the Decoders from the front panel, press the Menu button. Using the Select knob, go to the Setup menu. Validate using the Enter button.

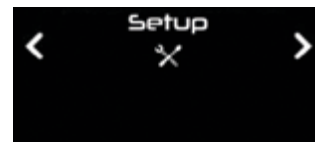

Then, using the Select knob, go down the list and select Decoders. Confirm with the Enter button.



Finally, select the decoder you want to configure. Confirm with the Enter button.

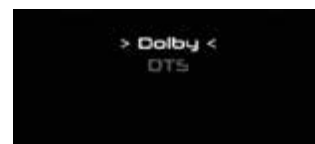

# 8.4 \_USING THE GRAPHICAL INTERFACE

## 8.4.1 \_LISTENING FORMAT SELECTION

To activate a surround upmixer:

1. Click on the “IN sources” menu item of the lateral menu to go to the Sources page;
2. Select a Listening Format in the drop down list.



## 8.4.2 \_DECODER CONFIGURATION

To configure the decoder parameters for the Dolby, DTS and Auro-3D decoders:

1. Click on the “IN sources” menu item of the lateral menu to go to the Sources page;
2. In the Sources page, click on the Manage button in the Decoders section. This gives you access to the decoder settings described below.



## 8.5 \_DECODERS SETTINGS

The different decoder settings given below are available through the graphic interface or through the front panel screen.

### 8.5.1 \_GENERAL SETTINGS

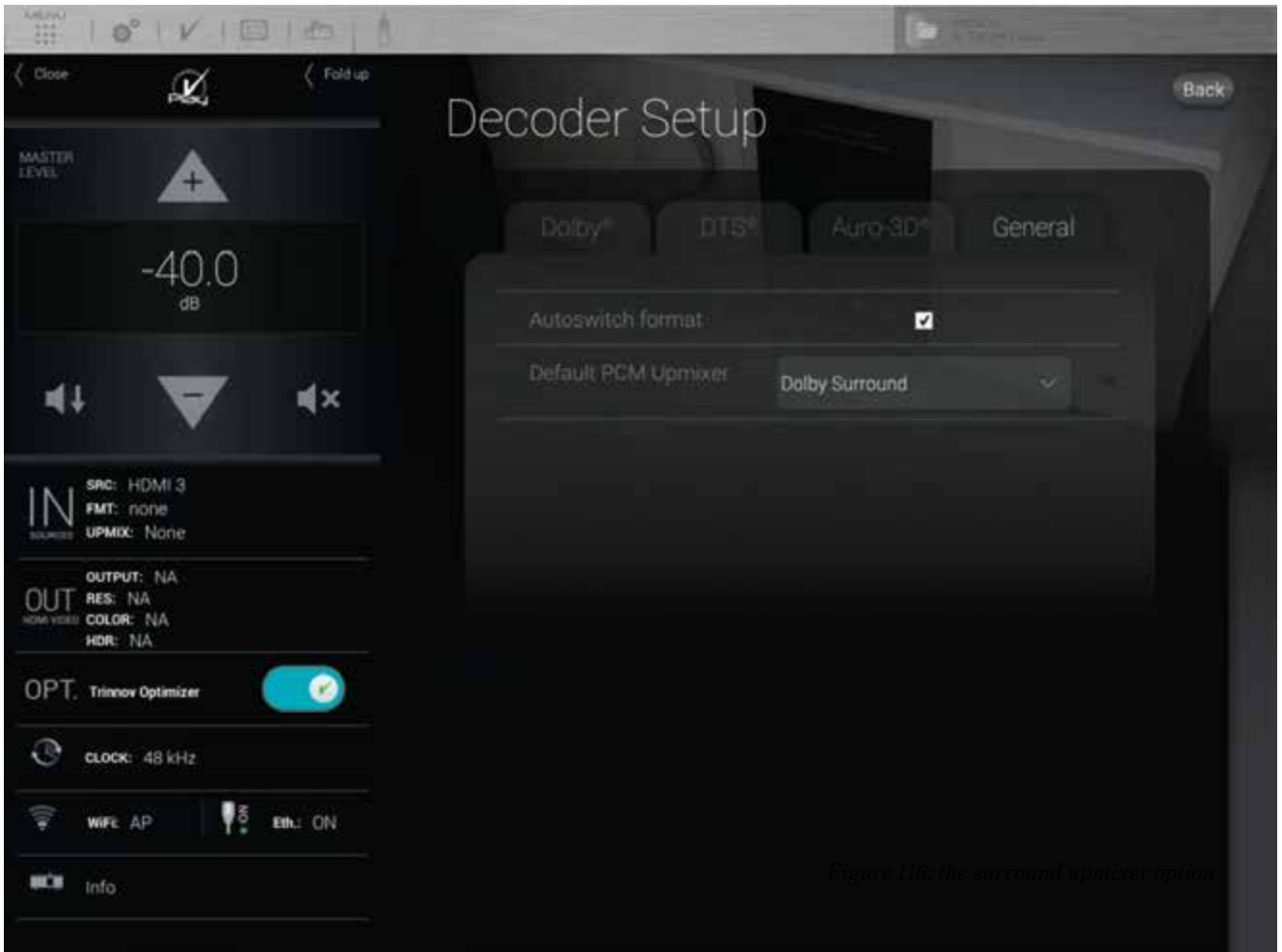

Figure 116: the surround upmixer option

Figure 115: Decoder Setup Menu

The General tab provides you different settings to configure the decoding behavior of the Altitude<sup>32</sup> that does not directly concern the decoders.

- **Autoswitch format:** When this option is activated, the Altitude<sup>32</sup> will automatically switch to the input format of the decoder. The Altitude<sup>32</sup> virtually replaces the speakers at their ideal position recommended by the current decoder and provides you the best immersive conditions.
- If this setting is not enabled, you must manually select the desired source format in the Setup/Source menu of the Advanced interface. If this setting is not enabled, you have to manually select the correct source format in the Setup/Source menu of the Advanced interface.
- **Default PCM Upmixer:** The PCM format has no decoder, thus there is no assigned speaker layout. This setting allows the assignment of a default layout and upmixer for incoming PCM content.

## 8.5.2 \_DOLBY DECODER SETTINGS

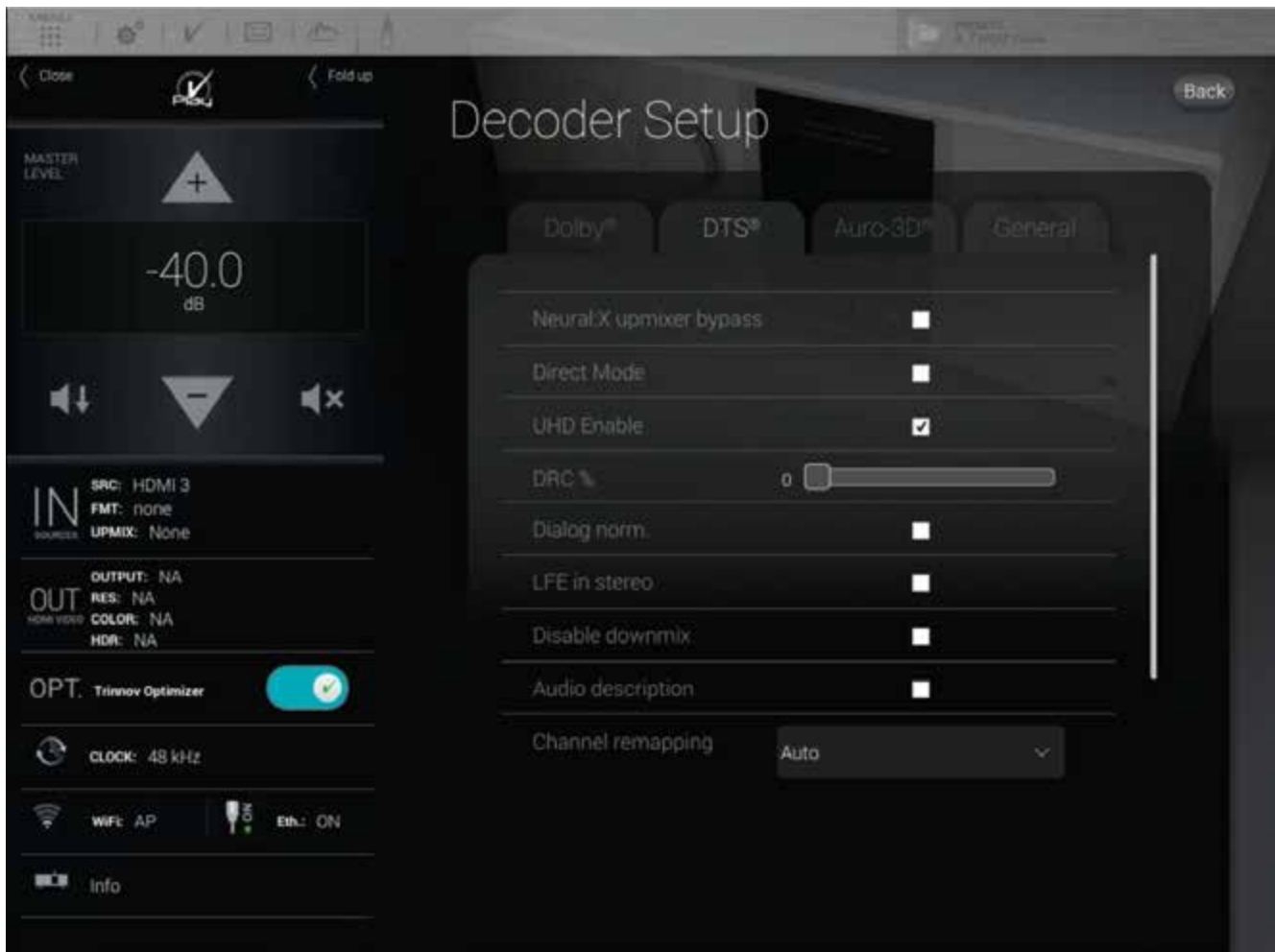

Figure 116: Dolby decoder settings

- **Surround Upmixer:** switch on/off the Dolby surround upmixer;
- **Enable center spread:** spread the Center channel across the Left and Right speakers. Creates a wider sound stage, recommended for playing musical content;
- **Loud Mgmt:** use the loudness management information provided in the incoming signal's metadata;
- **DRC Settings:**
  - **Auto:** Automatic DRC low level boost and high level cut;
  - **Enabled:** Enable the Dynamic Range Control management;
  - **Disabled:** Disable the Dynamic Range Control management;
- **DRC Low-Level Boost:** Amount of low-level boost;
- **DRC High-Level Cut:** Amount of high-level cut;
- **Legacy decode:** extract the legacy content (5.1 or 7.1) from the incoming Dolby Atmos content.

### 8.5.3 \_DTS DECODER SETTINGS



Figure 117: DTS Decoder Settings

- **Neural:X Upmixer Bypass:** disable the Neural:X Upmixer ;
- **Direct Mode:** In “Direct Mode,” the audio is extracted and reproduced as closely as possible to what the content creator intended. At a high-level, direct mode attempts to most closely preserve the original speaker layout with no additional processing to take advantage of additional speakers.
- **UHD Enable:** Allows rendering on the 3D object. If this function is disabled, the decoder will play only on ears-level speakers;
- **DRC %:** set a percentage of Dynamic Range Control ;
- **Dialog norm:** use the incoming metadata to adjust the level of the center channel;
- **LFE in stereo:** send the LFE to a pair of subwoofers ;
- **Disable downmix:** downmix surround formats into stereo is disabled;
- **Audio description:** switch on the visual description track intended for the blind and visually impaired ;
- **Channel remapping:** this setting is only applicable to surround formats :
  - None: No channel remapping is applied;
  - Auto: apply automatic channel remapping that matches the incoming channels to the speaker system;
  - Auto on DTS configs: apply automatic channel remapping accordingly to some specifics speakers configurations determined by DTS;
  - 2.0 – 7.1 settings: force playback on a specific speaker configuration such as 7.1 independently from the incoming channels.

## 8.5.4 \_AURO-3D DECODER SETTINGS

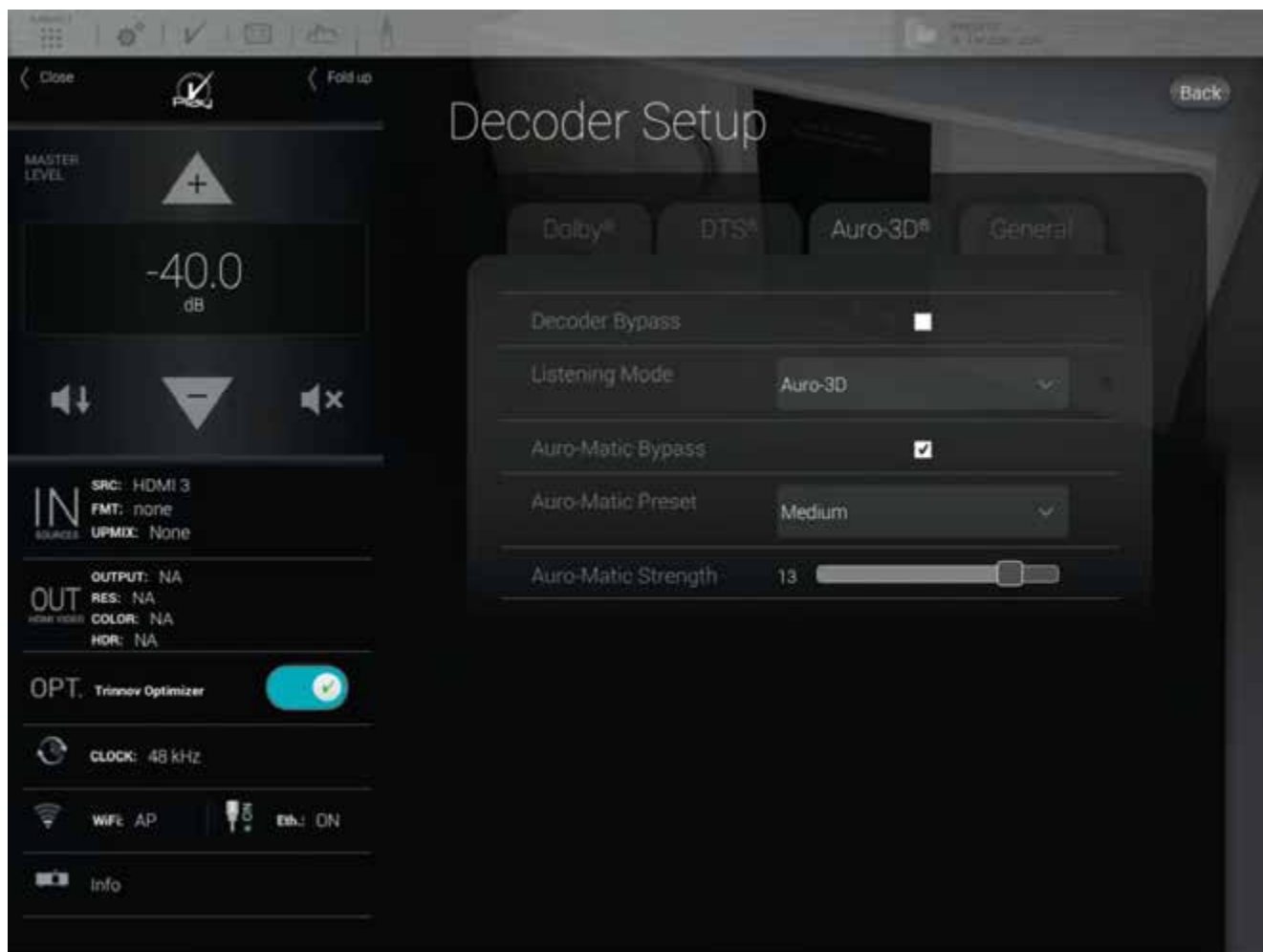

Figure 118: Auro-3D decoder settings

- **Decoder bypass:** bypass the Auro-3D decoder;
- **Listening mode:**
  - **Auro-3D:** enforce playback on the Auro-3D speaker layout. Incoming surround content is upmixed to the Auro-3D format ;
  - **Surround:** enforce playback on the surround speaker layout so that height speakers are disabled. Incoming stereo content is upmixed to a surround format and incoming Auro-3D content is downmixed to a surround format.
  - **Stereo:** enforce playback in stereo. Incoming surround content is downmixed to the stereo format.
- **Auro-matic Bypass:** switch on/off the Auro-matic upmixer;
- **Auro-matic Preset:** choose different settings for the Auro-matic upmixer;
- **Auro-matic Strength:** sets the strength of the Auro-matic upmixer.







# 9 \_HDMI FEATURES

New Altitude's firmware introduces a new menu dedicated to collect various HDMI information on the devices plugged to the unit, the various handshakes (EDID, HDCP) between them, and the current video status.

We hope this data will help you in your setup procedure and otherwise will please the more tech-savvy among yours!

The following document will explain some of the data and features displayed in this new menu but does not intend to be exhaustive.

 NOTE: This new feature is only available to users of HDMI 2.0 boards, the one with 7 inputs and 2 outputs.

## 9.1 \_HOW TO ACCESS THE HDMI MENU

This new menu is accessible by clicking on the "OUT HDMI VIDEO" on the left panel of the interface, it will extend on the right as other menus accessible through the left panel.

 NOTE: an HDR indicator has been added to the "OUT HDMI VIDEO" section of the left panel menu, it will display HDR10, DV or HLG depending what's signal is incoming.

The first Tab of this menu, "Video", displays in almost real time the parameters seen by the HDMI board on the current input and on both outputs, so resolution, frame rate, HDCP, syncing etc.

The second Tab "Setup" let you select in which mode, HDMI 1.4 or HDMI 2.0, you want the inputs to be configured. Setting an input to HDMI 1.4 may help with the compatibility of some devices.

 NOTE: outputs are not configurable, there is a hardware limitation that does not allow it. So output 1 is HDMI 1.4 only and output 2 is HDMI 2.0.

The third tab "In EDID" report the current EDID of the Altitude, it is the EDID that is sent to sources plugged to the Altitude. (The video parameters are not reported as they depend of the display used).

The fourth tab "Out EDID" is the EDID read from the devices connected to the HDMI outputs of the Altitude. You can thus check if all expected video modes and features are recognized.

 NOTE: You will find a more detailed description of all these features in the next chapters.

## 9.2 \_VIDEO TAB

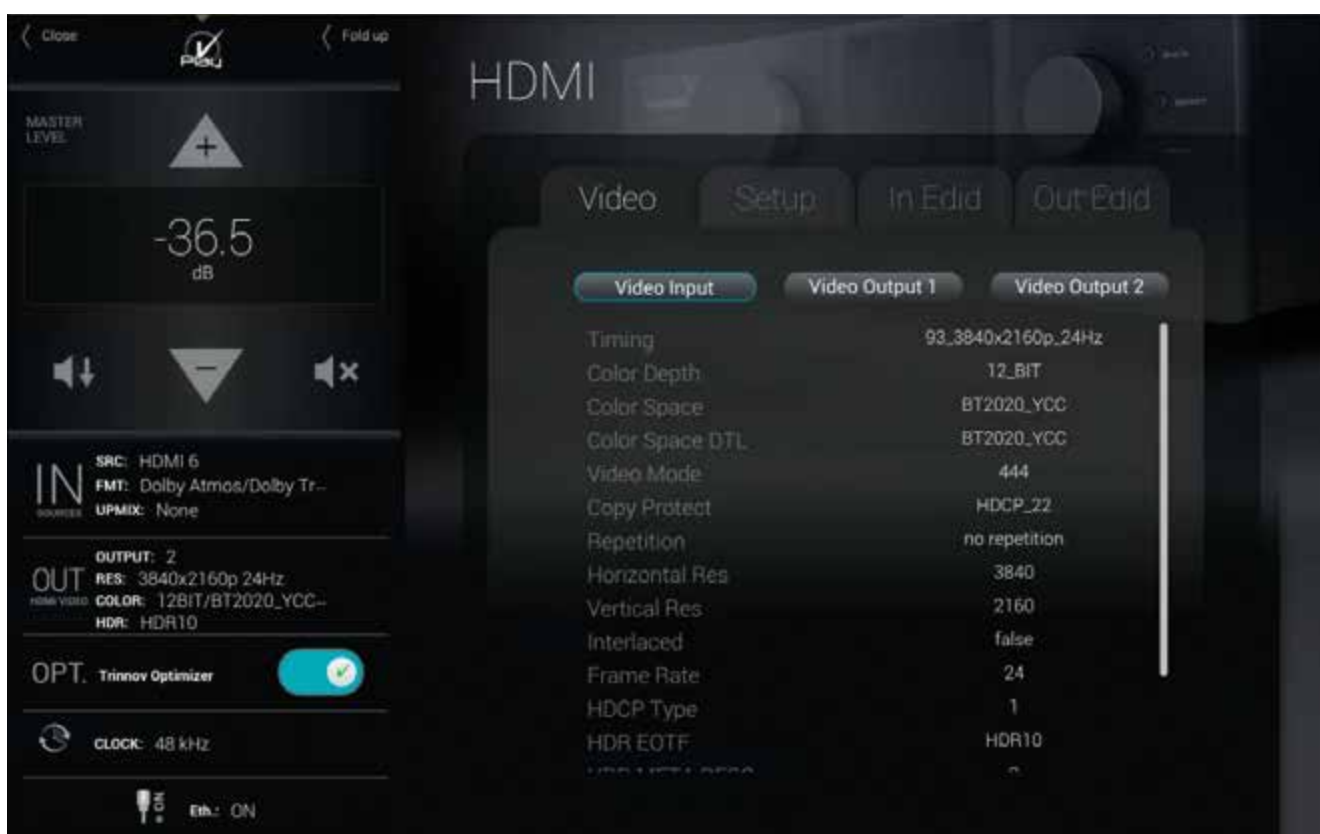

The Video Tab is divided into 3 sub-tabs:

- a video input tab used to display information from the incoming signal from the currently selected HDMI source/input.

2 video outputs tabs, one for each HDMI output connector

For both you will find video information:

- **Timing:** Input timing format status
- **Color Depth:** Input Color Depth Status
- **Color Space:** Useful when there is a bad color problem
- **Color Space DTL:** More details on color space
- **Video Mode:** Input Video Mode Status
- **Copy protect:** Copy protection status (for video output)
- **Repetition:** This status provides information to the host for the pixel repetition of the input video stream.
- **Horizontal res / vertical res / interlaced / Frame rate:** Actual numbers for input timing format status.

### HDCP type

- **HDR EOTF:** HDR status
- **HDR META DESC:** Video high dynamic range status
- **SYNC:** When Sync status is detected, then the other input status are likely valid.

### Source Type

- **Video 3D Struct:** Video 3D structure status
- **State:** State Status (video output)
- **Detect:** Sink Detect Status (video output)
- Fields about copy protection

The Video input also has information on the HDR status (note: HDR10 is equivalent to SMPTE2084, and DV is Dolby Vision).

Note that the color depth fields reported in the video outputs are indicating the display's capabilities, not the current mode used (please refer to the video input section for that info).

### 9.2.1 \_TROUBLESHOOTING AN HDMI ISSUE

Please find below the fields that you should monitor while experiencing the issue. To properly help you, the support team asks you to check these, so please, take a look before calling them.

**!** NOTE: Please contact support@trinnov.com, they will send you the HDMI troubleshooting form to fill.

#### \_9.2.1.1\_ VIDEO INPUTS

The basic idea is to check that video features match what you expect from the source configuration.

Also, it is very important to check the “SYNC“ field, which should be at “DETECTED“ if everything is fine, “SOURCE TYPE“ that will indicate if the source is HDMI 1, HDMI 2 or DVI. At last, “Copy Protect“ is essential.

If you play a UHD disc, you should have “HDCP\_22“ reported.



### \_9.2.1.2\_ VIDEO OUTPUTS

First look at the Video outputs should be on the “Detect” field. It simply indicates if something is plugged into the connector. If that’s not the case, check your connections!

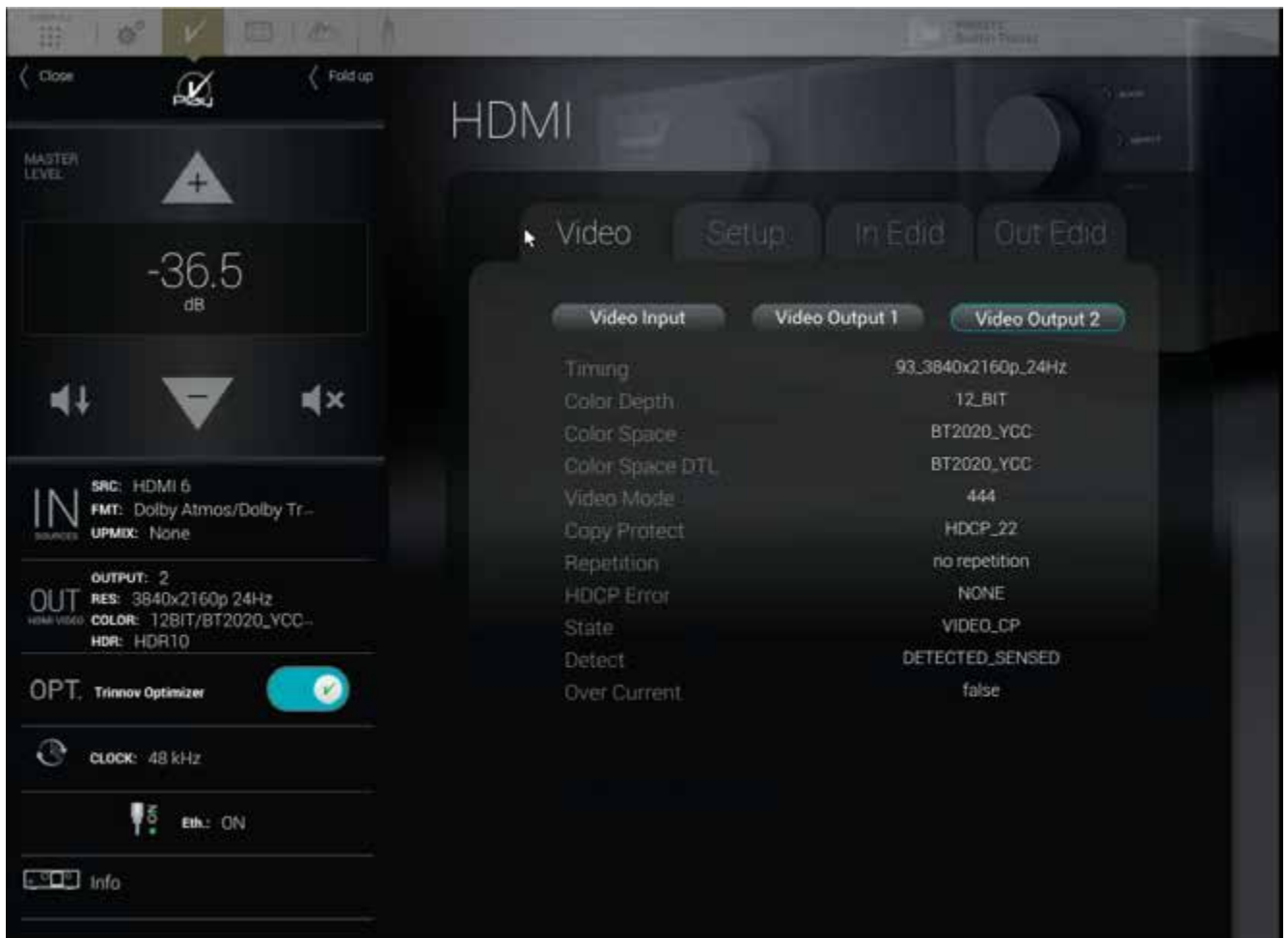

Next “State” and “Copy Protect” are important too. The first may directly show a failed copy protect handshake (“VIDEO\_CP\_ERR\_AV\_MUTED”).

### 9.3 \_SETUP TAB

This tab let you configure HDMI inputs in HDMI 1.4 or 2.0 individually. This feature is intended to improve compatibility with some sources that do not handle correctly HDMI 2.0 components on their outputs.

HDMI connectors are shown as on Altitude’s back panel. Green connectors are HDMI 1.4 and golden connectors are HDMI 2.0. To change the state of a connector, just click on it. It will directly switch color. However be aware that a reboot of the unit is mandatory for the change to take effect.



**NOTE:** The default settings are inputs 1 to 3 HDMI 1.4 and inputs 4 to 7 HDMI 2.0

## 9.4 \_IN EDID TAB



The In Edid menu is composed of 2 sections:

- The audio input section
- The video input section

The audio input section is describing the “short audio descriptors”; a small set of data describing to the source that are the audio formats supported by the Altitude. You will find format name, the number of channels supported, sampling rates and a misc field whose value is vendor specific and depends on the option you may have chosen (for example if your unit is equipped with 3D decoders the DTS\_HD misc section will report it).

**NOTE:** Dolby TrueHD is reported as "MLP", DTS\_HD is used for both DTS-HD HR and DTS-HD MA. If the short audio descriptors reported in this section are just basic audio with 2 channel PCM at 48kHz then a problem may have occurred during the board's EDID setup.

The video input section basically only reports if something has been overridden compared to the EDID built automatically by the HDMI board from the EDID received from its outputs. Thus and as we don't process video, the EDID is mostly a copy of the display's one (that you can read on the Out EDID Tab, see below).

## 9.5 \_OUT EDID TAB



The Out EDID Tab reports the EDID information read on the outputs ports if and only if a display is connected to at least one of them. You will find:

### 9.5.1 \_AUDIO

- Short Audio Descriptors of the display if it can handle sound,
- Speaker Allocation, basically what kind of speaker is available (accepted input signal can vary from the speaker layout used by the display).

### 9.5.2 \_VIDEO

- HDMI DATA BLOCK: a list of video features and if they are supported or not
- HDMI FORUM DATA BLOCK: an extension of the previous for HDMI 2.0 only content. A “max\_tmnds” field inferior to 600 in that section indicates that the display does not support 18Gbps signal.
- COLORIMETRY: What are the color spaces handled by the display.
- HDR Static: HDR capabilities of the display. Basic HDR10 support will require the “EOTF-SMPTE\_St\_2084” field set at true.
- VIDEO TIMINGS: list of Horizontal/Vertical/frame rate handled by the device. Note that the list may not be exhaustive.

### 9.5.3 \_REFRESH BUTTON

In the upper right corner of the Out EDID Tab, you will find a refresh button. You can use it if the section is empty to populate it (the operation will take something like 5 seconds). It could be the case if the display is plugged in after the Altitude has been booted for instance.

# 10 \_MANUAL CALIBRATION

This chapter explains very important tips to ensure a smooth and safe calibration process if you chose to proceed to a manual calibration. However, we strongly recommend using the Wizard to calibrate your system.

## 10.1 \_VERY IMPORTANT TIPS

### Important Notes:

- Active Crossovers need to be calibrated before Optimizer calibration.
- Master 48 kHz clock modes should be used for calibration (Factory default for the microphone input.)

### Avoiding feedback loops:

- Always MUTE the processor as the first step of the calibration procedure. Muting the outputs does not affect the calibration signal.
- Be careful with feedback issues when you change the routing. You could make loops between the microphone and the loudspeakers.

### Avoiding warning messages during calibration:

- Disable the subwoofer's built-in filters: a narrow bandwidth can disturb the measurement.
- Adjust levels between amplifier/active speakers before calibration to avoid dangerous level jumps.

## 10.2 \_CHECKLIST BEFORE YOU START

### Please go through the following checklist to make sure you are ready to start the calibration process:

- You've read carefully the whole chapter about the Altitude<sup>32</sup>'s Essential Tools and Settings that you'll be using throughout the calibration process.
- The speaker layout (including multi-amplified speakers) has been specified in the Altitude<sup>32</sup> Speaker/Room Setup Tool.
- The routing of the speakers/drivers has been verified by playing pink noise with the Altitude<sup>32</sup> Speaker/Room Setup Tool.
- All the speakers (including the subwoofers) are installed in their final positions and orientations as well as connected to their amplifiers in the proper polarity.
- The measurement microphone is switched OFF, placed securely on a mic stand or camera tripod and connected to the Altitude<sup>32</sup> MIC input.
- The MIC input is selected as a source for a 5 pin XLR microphone.
- You have access to the Advanced Settings user interface, via a screen directly connected to the Altitude<sup>32</sup>, or through a VNC client.

## 10.3 \_IMPORTANT RECOMMENDATIONS FOR MICROPHONE PLACEMENT

Please see the Using Trinnov 3D microphone chapter in section 6.6.

## 10.4 \_CALIBRATE THE ACTIVE CROSSOVERS (OPTIONAL)

This chapter explains how to calibrate the active crossovers included in the Altitude<sup>32</sup>. It assumes that you are familiar with active crossovers and multi-amplified speakers and is not intended as a course. If you are not using the active crossover functionality of the Altitude<sup>32</sup>, please skip to the next chapter.



**!** IMPORTANT NOTE: Carefully read the entire chapter about the Altitude32 Essential Tools and Settings that you will be using throughout the calibration process.

**!** NOTE: Master 48 kHz clock modes should be used for calibration (Master 48kHz highly recommended).

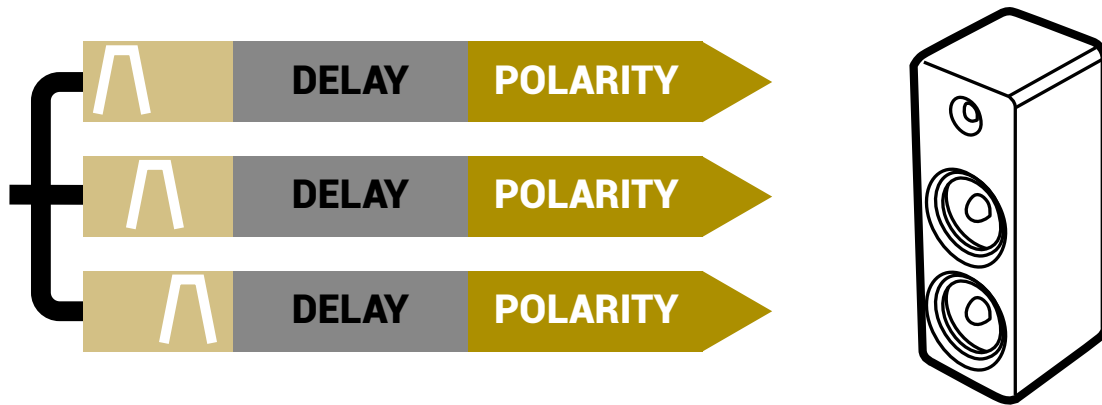

Figure 126: Overview of the active crossovers signal flow

#### 10.4.1 \_OVERVIEW OF THE CROSSOVER SETUP PROCEDURE

The overall setup and calibration process of the Altitude<sup>32</sup> active crossovers performed through two different tools:

- Use the Speaker/Room Setup Tool to:
  - Configure the number of ways and the crossover frequencies;
  - Verify the routing of the Altitude<sup>32</sup> outputs to the correct drivers.
- Use the Setup/Active Xovers page of the Advanced Settings interface to:
  - Configure the advanced crossover settings such as specific frequencies for each driver and the type of filters (optional);
  - Use the Processor/Meters page to adjust the master output level;
  - Perform the automated calibration of the active crossover: this will automatically determine the level, delay and polarity of each driver;
  - Manually adjust levels, delays and polarities of each driver;
  - The first 2 steps of this process were explained in the previous chapter. This chapter explains the next steps.

#### 10.4.2 \_CONFIGURE THE ADVANCED SETTINGS (OPTIONAL)

The Altitude<sup>32</sup> includes the following advanced crossover settings:

- Types of filters: Bessel order 2, 3 and 4; Linkwitz-Riley order 2 and 4; Butterworth order 2, 3 and 4;
- The specific crossover frequency for each driver;
- Level, Polarity and Delay adjustment on each way (driver);



IMPORTANT NOTE: Setup of the crossover filters can be done simultaneously for multiple speakers thanks to their respective Link button. Linking has to be done before changing parameters. Please refer to the speaker manufacturer's specification to determine the type of filters and crossover frequency.

The **Setup/Active Xovers** page displays one tab for each loudspeaker. The number of loudspeakers displayed depends on the number of loudspeakers specified in the Speaker/Room Setup tool.



Figure 119: advanced crossover settings

The following settings are available for each loudspeaker:

- The **type** of high-pass or/and low-pass filters is chosen in the dropdown menu using ▼
- The **cut-off frequency** of each filter is set by using the ◀ arrows ▶ or by manually entering the frequency
- Level and delay can be adjusted on each way (driver).
- Mute and Invert Polarity buttons are also available.
- Two additional IIR filters are available under the name of **“Constant-directivity horn” EQ** and **Half “Constant-directivity horn” EQ**. The purpose of such filters is to boost the high frequencies for speakers that use constant-directivity horns. These speakers tend to have too little energy at the highest frequencies in sweet spots. Depending on the horn you are using, you may want to boost the high frequencies by 3 or 6 dB/oct, from about 3kHz.

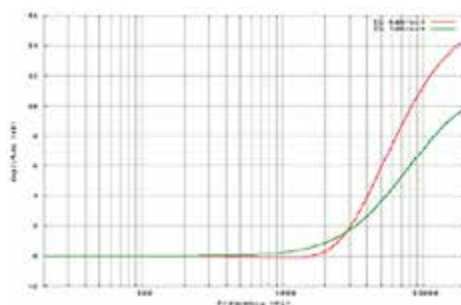

Figure 120: “Constant-directivity horn” EQs

- The **Apply** button is highlighted as soon as a parameter is modified and is used to compute and load the new settings into the processor. Once compute is finished, the biking gears icon disappears from the notification bar and filters are applied to the outputs.
- If the changes are unwanted, press the **Cancel Changes** button to cancel your modifications.
- If change is accepted, press the **Save** button of the preset of your choice in the **Presets** page. Otherwise, changes will be lost.

The theoretical model of the specified filters is represented as follows:

- The green curve represents the theoretical low-pass filter response
- The red curve represents the theoretical high-pass filter response
- The blue curve represents the theoretical resulting response of the speakers

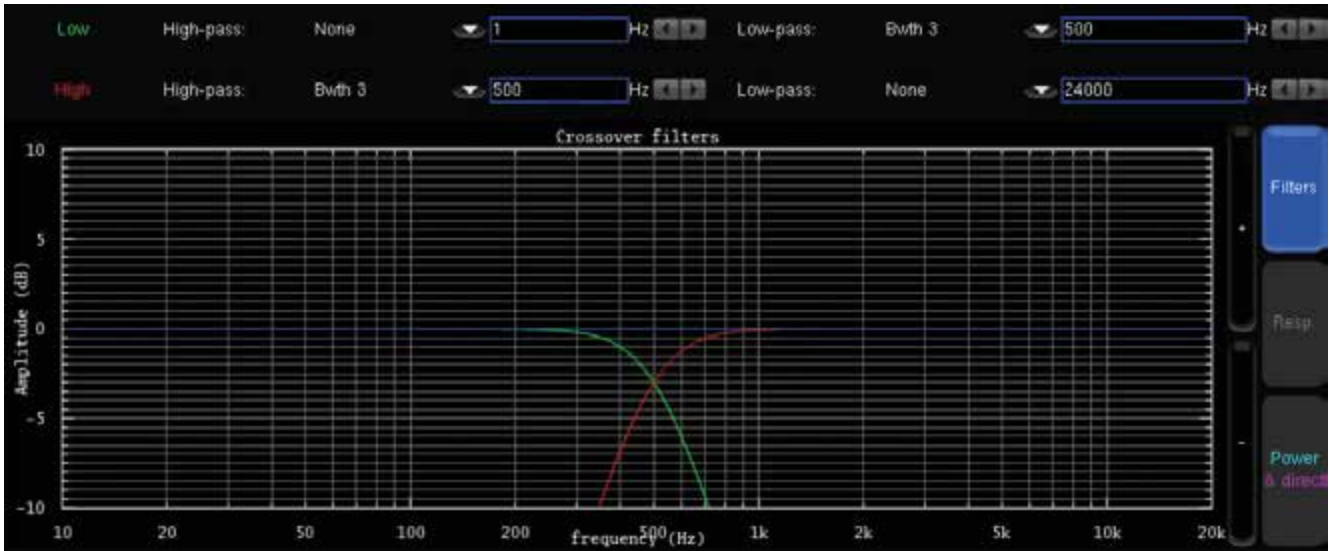

Figure 121: theoretical model of the specified filters

### 10.4.3 \_ADJUST THE MASTER OUTPUT LEVEL

The Altitude<sup>32</sup> requires a minimum Sound Pressure Level for proper calibration of the active crossovers. Until that minimum SPL is reached, the test signal will keep playing through the same driver. For safety matters, we recommend performing that first calibration as if it were a test.

**First, be sure that you selected the proper microphone input:**

- MIC IN if you are using a 5-pins XLR microphone;

**Set a safe output level:**

1. Decrease Master Level to -40 dB;
2. Press the Mute button to cut the outputs (this step must ALWAYS be performed before pressing on the Calibrate button to avoid any feedback loop);
3. Take off the cover and switch on the microphone;
4. Press the Calibrate button in the Setup/ActiveXovers page of the Advanced Settings interface;

**Adjust the output level:**

1. Increase the master level until the test signal moves to the second driver;
2. Use the Altitude<sup>32</sup>'s metering tools, which are automatically displayed on the screen to check the level of the microphone inputs;
3. Use your ears to evaluate the perceived SPL of each driver and, if possible, increase the master output level to ensure that an optimal SPL is reached for all the drivers. This will also improve the quality of your measurements;
4. Use the Cancel button to stop the calibration (optional).



Figure 122: Crossover calibration page



Figure 123: Metering page

Once the level is adjusted, you can move to the next step to perform the final calibration of the active crossover.

## 10.4.4 \_CALIBRATE THE ACTIVE CROSSOVERS

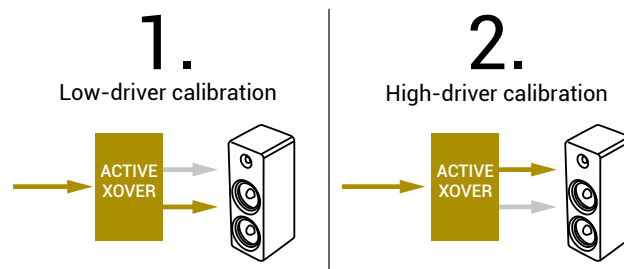

Figure 124: the steps of the calibration process

Once the master output level is set (see previous step), the Altitude<sup>32</sup>'s crossover calibration tool will automatically set up the level, delay and polarity of each driver.



Figure 127: Performing the calibration of the active crossovers

Before calibration, please note:

- The calibration procedure has to be done individually for each speaker;
- An MLS signal is sent to each driver of the selected speaker when the Calibrate button is selected;
- At the end of the calibration process, a warning message states that a new calibration of the entire system is required.

Remain in the **Setup/ActiveXovers** page of the Advanced Settings interface to perform the calibration of the active crossovers:

- If two or more speakers are linked, please **unlink** them by turning off the **Link** button;
- Follow the microphone placement instructions (see the previous chapter);
- Make sure the measurement environment is silent;
- Press the **Mute** button to cut the outputs (this step must ALWAYS be performed before pressing on the **Calibrate** button);
- Press the **Calibrate** button in the **Setup/ActiveXovers** page of the Advanced Settings interface;
- Follow the on-screen instructions regarding the microphone.

## 10.4.5 \_VERIFY THE SOUND OF THE CALIBRATED CROSSOVERS

Once the calibration of the active crossovers is finished, it is critically important to verify the sound of the related speakers to identify any possible issues:

- Visualize the acoustic graphs of the speakers connected to the active crossover;
- Listen to the speakers connected to the active crossover.

### \_10.4.5.1 \_VISUALIZE THE ACOUSTICAL GRAPHS FOR EACH SPEAKER

You can visualize the results in two forms:

- The measured impulse response of each way: you can see whether the drivers are correctly synchronized.



Figure 125: Measured impulse response of both drivers

- The recombined amplitude response of the speaker: You can see whether the combination of the drivers is constructive and you can observe the effects of level/delay/polarity modification on the combined amplitude of the speaker. Two curves are displayed: one showing the total acoustic output of the speaker (including the room) and one showing the amplitude of the direct front and early reflections. Comparing both curves will indicate whether the crossover preserves the directivity of the speaker: The two curves will look more alike when the acoustic summation is optimized for the primary listening position.

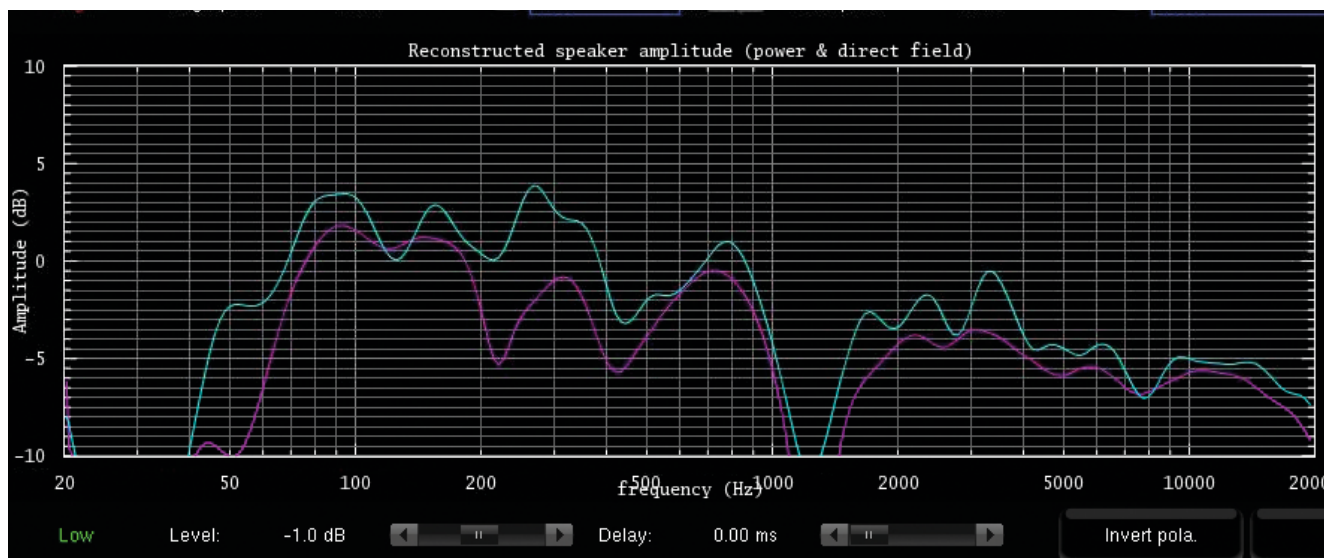

Figure 126: Recombined amplitude response of the speaker

**NOTE:**

- The levels, delays and polarities set previously are ignored during the calibration. In other words, adjusting these parameters before launching the calibration will have no effect on the result.
- Under some circumstances, the automatic crossover algorithm may suggest inverted polarities for a driver from one speaker to another. This can be explained by various factors:
  - The physical polarity of one speaker is, indeed, inverted (from a cabling issue, as an example). In this case, the correction suggested by the Optimizer should be applied to improve audio quality.
  - Two adjacent drivers (for instance Mid and High) are phase-shifted by an amount of about 90°. In this case, the Optimizer provides more uncertain results as it gets harder to see whether the drivers are in or out of phase. If you are not comfortable with the results provided by the Optimizer, you can correct them manually afterwards (via the button "Invert polarity").

### \_10.4.5.2 \_LISTEN TO EACH SPEAKER CONNECTED TO THE CROSSOVER

Listen carefully to each speaker connected to the crossover. You can play pink noise from the Altitude<sup>32</sup> and/or play your favorite music/cinema samples.

### 10.4.6 \_SAVE THE PRESET

Last but not least, don't forget to save the preset to avoid losing the crossover settings.

## 10.5 \_CALIBRATE THE SPEAKERS IN THE ROOM



**IMPORTANT NOTE:** In order to perform a proper calibration, it is important to carefully read the entire chapters about the Essential Tools and Settings and Getting Ready for Calibration to learn about the Altitude<sup>32</sup> audio clock settings, audio utilities (metering tools, pink noise and solo/mute buttons) and microphone placement recommendations.

### 10.5.1 \_OVERVIEW OF THE CALIBRATION PROCEDURE

If your speakers have been specified correctly, the calibration process is a relatively straightforward process:

1. Adjust the master output level to achieve good quality measurements;
2. Start the automated calibration: The Altitude<sup>32</sup> will measure the acoustical response of each loudspeaker in the room;
3. Compute the optimization filters;
4. Save one or more presets with your preferred optimization settings.

### 10.5.2 \_ADJUST THE MASTER OUTPUT LEVEL

To access the calibration page from the Altitude<sup>32</sup> Main page:

Click on the Setting button in the top menu to open the Advanced Settings user interface. Go to the Optimizer Settings/ Calibration page.

The Optimizer requires a minimum Sound Pressure Level for proper calibration. Until that minimum SPL is reached, the test signal will keep playing through the same speaker. For safety matters, we recommend performing that first calibration as if it were a test.

**Set a safe output level:**

1. Decrease Master Level to -40 dB;
2. Press the Mute button to cut the outputs (this step must ALWAYS be performed before pressing on the Calibrate button);
3. Press the Calibrate button in the Calibration tab in the Optimizer Settings page of the Advanced Settings interface;
4. Follow the on-screen instructions regarding the microphone: take off the cover and switch it on.

### Adjust the output level:

1. Increase the master level until the test signal moves on to the second speaker;
2. Use the Altitude<sup>32</sup>'s metering tools in the Processor/Meters page to check the level of the microphone inputs;
3. Use your ears to evaluate the perceived SPL of each driver and, if possible, increase the master output level to ensure that an optimal SPL is reached for all the speakers. This will also improve the quality of your measurements;
4. Use the Cancel button to stop the calibration (optional).

During this process, you will need to move back and forth between the calibration page and the metering page:

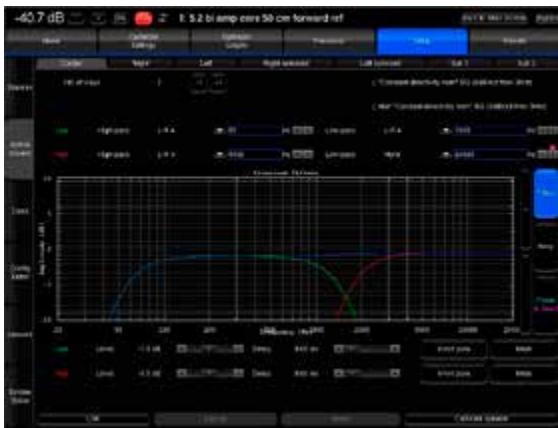

Figure 127: Calibration page



Figure 128: Metering page

### 10.5.3 \_NORMAL CALIBRATION SEQUENCE

Remain in the Optimizer Settings/Calibration page of the Advanced Settings interface to perform the final calibration:

- Follow the microphone placement instructions (see the previous chapter);
- Make sure the measurement environment is silent;
- Press the Mute button to cut the outputs (this step must ALWAYS be performed before pressing the Calibrate button);
- Press the Calibrate button in the top right corner of the page;
- Follow the on-screen instructions regarding the microphone: take off the cover and switch it on.



**IMPORTANT NOTE:** In order to perform a proper calibration, it is important to carefully read the entire chapters about the Essential Tools and Settings and Getting Ready for Calibration to learn about the Altitude<sup>32</sup> audio clock settings, audio utilities (metering tools, pink noise and solo/mute buttons) and microphone placement recommendations.



Figure 129: The calibration page



## 10.5.4 \_COMMON PROBLEMS DURING CALIBRATION

Please see chapter 6.9.3.

## 10.5.5 \_CALIBRATION STATUS

The calibration status has 3 possible values:

- **Yes:** If no problem occurred during the measurement. After calibration, the Top Bar indicates NOT READY, which means no sound can go through the processor until the optimization filters are computed.
- **Partial:** If the calibration was stopped in the middle of the measurement process.
- **No!** When no measurement has not been performed.



Figure 130: Calibration status

## 10.5.6 \_CHECKING THE SPEAKER POSITIONS DURING/AFTER CALIBRATION

Please see chapter 6.12

## 10.5.7 \_MULTI-POINT MEASUREMENTS (OPTIONAL)

Please see chapter 6.9.2

## 10.5.8 \_COMPUTE THE OPTIMIZATION FILTERS

After the calibration is completed, the Top Bar indicates NOT READY, which means no sound can go through the processor until the optimization filters are computed.

**-18.0 dB**      **NOT READY** 1: Trinnov setup wizard

To compute the optimization filters for your speaker measurements:

- Go to the Optimizer Settings/Calibration page;
- Press the Compute button to start the calculation of the compensation filters. This will also create the Optimizer graphs



### NOTE:

- The top bar will display a gear wheel icon and a graph icon during computation.
- An onscreen message notifies the end of the computation.
- The speaker icon indicates that the Optimizer is ready.
- Computation time varies depending on the number of speakers in the system and on the Optimizer parameters.



### IMPORTANT NOTE:

- Once the speaker system has been calibrated, every change can be applied through recalculation of the filters by pressing the Compute button.
- Performing new measurements is not required unless:
  - Speakers/Furniture/listening positions change in the room;
  - the active crossover filters are modified;
  - The number of speakers is modified;
  - The channel order is modified.

## 10.5.9 \_SAVE THE PRESET

Last but not least, be sure to save the preset to make sure all your preferred measurements and computed filters are not lost.

# 11 \_VERIFY THE SOUND OF YOUR OPTIMIZED SYSTEM

| The Altitude<sup>32</sup> is now ready to be used but you may want to fine tune and personalize it to your own taste.

## 11.1 \_VISUALIZE THE GRAPHICS

| Please see Analyzing the results chapter in section 6.11

## 11.2 \_LISTEN TO THE SYSTEM

| Most importantly, listen carefully to your system by playing your favorite music and cinema samples. As an option, you could also play pink noise from the Altitude<sup>32</sup> to perform additional acoustical measurements with your own acoustical measurements tool.

## 11.3 \_SPEAKER SET WINDOW

| The Speaker Configuration page can be accessed through the Top Menu of the Altitude<sup>32</sup>'s graphic user interface, highlighted below.



Please see chapter 6.4.

**!** NOTE: To avoid repetitions, the use of the speaker set window is not clearly covered in this section but the speaker configuration works the same as in the Wizard (only screenshots differed).

## 11.4 \_BASS MANAGEMENT WINDOW

| The Bass Management Configuration page can be accessed through the Top Menu of the Altitude<sup>32</sup>'s graphic user interface, highlighted below.

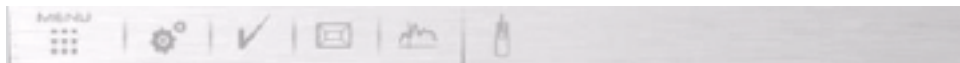

Please see chapter 6.4.

**!** NOTE: To avoid repetitions, the use of the bass management configuration is not clearly covered in this section but the bass management configuration works the same as in the Wizard (only screenshots differed).

## 11.5 \_SAVE PRESET

| Please see Naming, saving and loading presets in chapter 5.6.

# 12 \_IN CASE OF EMERGENCY, BREAK THE GLASS

Trinnov Audio has placed a particular Support case policy to ensure the best support possible in case of an inquiry. We are proud of the quality of our products and if a problem happens, or you have a question, our team will do their best to resolve it.

## 12.1 \_WHAT YOU WILL NEED

Before contacting a Trinnov Audio partner or the Trinnov Audio support, please make sure to be able to give the following information:

**The type of your machine:** Trinnov Audio makes different types of units. Please, always say that you own an Altitude<sup>32</sup> (you can also give the nickname of the Altitude<sup>32</sup>: AL.).

**The serial number of the unit:** To be able to have some information about your unit, the Trinnov Audio partner or the Trinnov Audio support will need the serial number of your machine. If you don't know the serial number of your unit, please go to your Altitude<sup>32</sup>'s back panel to find out its serial number or use the front panel menu (Menu/About). The 6-digit serial number is printed above the MADE IN FRANCE tag: it is "000008" in the example below:



Figure 131: a serial number as printed on the back panel of the Altitude<sup>32</sup>

- **The unit is connected to the network:** This is not an obligation but, as Trinnov Audio can perform maintenance remotely, having a machine connected to the network is heavily recommended. To be able to perform maintenance, your unit will need to be connected to the Trinnov Audio Server. In the main page, go to the **Network Status** in the Setup/Network page: you need to have "**Connected to Trinnov Audio Server**". If the status indicates "Local Network OK" or "**Internet Access**", it means that the Trinnov server can't be reached.
- **Port 22 is unable:** If you want from us to remote assist you, please check that the outgoing port 22 is disabled. You can check it in your network configuration or by asking to your network operator.
- **The serial number of the microphone (optional):** If you own a Trinnov 3D microphone and you have an inquiry about it, please note the serial number of your microphone. The serial number is written on the microphone in this format: vx-xxx.
- **Day, hour, minutes:** If you have an inquiry relative to a strange behavior of your unit that is not happening at the moment, please give to the technician a precise date, hour and if you have it minutes. Support can look at files in the unit (called logs) to resolve the problem. Please, remember that as a unit generate many logs. Without a precise time, it will be very difficult to find the problem.

## 12.2 \_TRINNOV AUDIO POLICY OF SUPPORT

### 12.2.1 \_CONTACT YOUR DEALER

The first step of any inquiry will be to contact your dealer. The Trinnov partners are trained to be effective on the Altitude<sup>32</sup> and will surely be able to help you.

### 12.2.2 \_SEND US AN EMAIL

The dealer will contact us directly if he can't help in the first place. If, by any chance, it's not the case, you can email us at [support@trinnov.com](mailto:support@trinnov.com). We will do our best to respond to you quickly.

### 12.2.3 \_CALL US

In case of an emergency, you can call us at 01-84-23-40-34 (France) or at +33-1-84-23-40-34 from abroad. Our Support technicians will assist you. They speak French and English.

The Trinnov Audio Support is open from Monday to Friday from 8 am to 1 am (CET).

# 13 \_APPENDIX

## 13.1 \_INSERT AN EXTERNAL STEREO DAC

As the Altitude<sup>32</sup> has a flexible and complete range of output types, it allows the use of other DACs when desired.

The analog outputs 1-2 are duplicated on the stereo analog SE outputs, AES outputs 1-2, as well as the SPDIF RCA and optical stereo outputs. Make sure that the routing is correct. It's up to you to choose the best way to feed your Hi-Fi external DAC.



Figure 132: Duplicated Outputs

## 13.2 \_REMOTE START AND STOP

The Altitude<sup>32</sup> can be remotely switched on via a Wake-on-LAN network message. Please ask a certified installer or an experienced IT technician for technical support.

It can also be switched off remotely over the network using the command provided within our automation protocol for that purpose, available for download on our Trinnov website. More information can be provided upon request.

## 13.3 \_AUTOMATION

The Altitude<sup>32</sup> can be remotely controlled from an automation system through RS232 or Ethernet. As an example, it is possible to create a Crestron® module to remotely control the Altitude<sup>32</sup> via RS232.

The specifications of the protocol as well as drivers for many automation systems (AMX, Control4, Crestron, Elan, RTI, Savant,...) are publicly available and can be downloaded from the Support / Download section of Trinnov Audio's website: <http://www.trinnov.com>

## 13.4 \_SIGNAL FLOW OF THE ALTITUDE<sup>32</sup>

### 13.4.1 \_SIGNAL FLOW OF THE ALTITUDE<sup>32</sup>

#### Not shown:

- Input & output routing / Physical inputs & outputs
- Manual input & output EQs

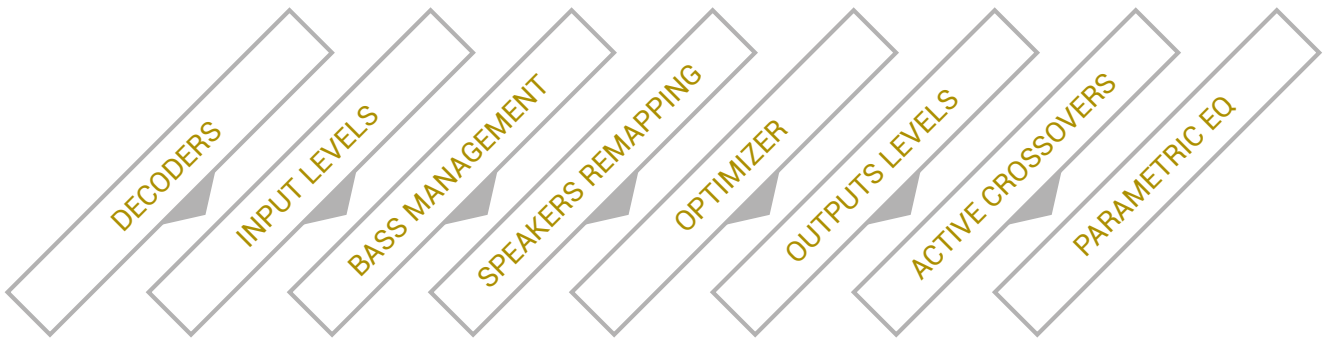

### 13.4.2 \_SETUP PROCESS AND FILTERS CALCULATION

Active-Crossovers are set up first following a semi-automatic calibration procedure.

The Optimizer's filters calculation is made from the speaker measurement.

Remapping filters are applied based on the source's input format and loudspeaker position measured during the Optimizer Calibration as soon as one of the remapping mode is enabled manually.

Bass management crossover filters are applied after and regardless of the loudspeakers calibration. The crossover frequencies and bass management mode can therefore be modified after calibration.

## 13.5 \_3D SPEAKER PLACEMENT RECOMMENDATIONS

For detailed information about speaker placement recommendations, please refer to the following documents:

- Auro-3D Home Theater Setup Installation Guidelines, available from Auro Technologies.  
[http://www.auro-3d.com/wp-content/uploads/documents/Auro-3D-Home-Theater-Setup-Guidelines\\_lores.pdf](http://www.auro-3d.com/wp-content/uploads/documents/Auro-3D-Home-Theater-Setup-Guidelines_lores.pdf)
- Dolby Atmos Home Theater Installation Guidelines, available from Dolby:  
<http://www.dolby.com/us/en/technologies/dolby-atmos/dolby-atmos-home-theater-installation-guidelines.pdf>

**!** NOTE: As of January 2016, the DTS X Home Theater Installation Guidelines are not yet available.

## 13.6 \_3D MEASUREMENT MICROPHONE

The purpose of the calibration microphone is to measure the characteristics of the loudspeakers and their layout in the room.

For each loudspeaker, the Optimizer gathers the following information:

- full 3D position
- amplitude response
- phase response

### 13.6.1 \_MICROPHONE SPECIFICATIONS

- 4 capsules in tetrahedron configuration.
- Individual compensation filters
- Frequency response within +/- 0.1dB across the 20Hz-24kHz frequency range
- Spatial resolution below +/-2°
- Built-in preamp
- A 9V PP3 LR61 battery powers capsules and electronics
- Camera / Microphone thread.

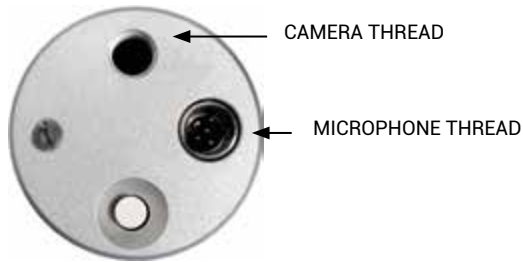

### 13.6.2 \_POWER SUPPLY

The power supply located in the base of the microphone uses a standard 9V PP3 LR61 battery. The red led indicates the battery Level. Replacing the battery requires removing the 3 screws at the bottom of the microphone.





### 13.6.3 \_INDIVIDUAL COMPENSATION FILE

The individual compensation file of the microphone used by the Altitude<sup>32</sup> can be modified in the Optimizer Settings/Calibration page. This file is delivered with the microphone on a USB stick.

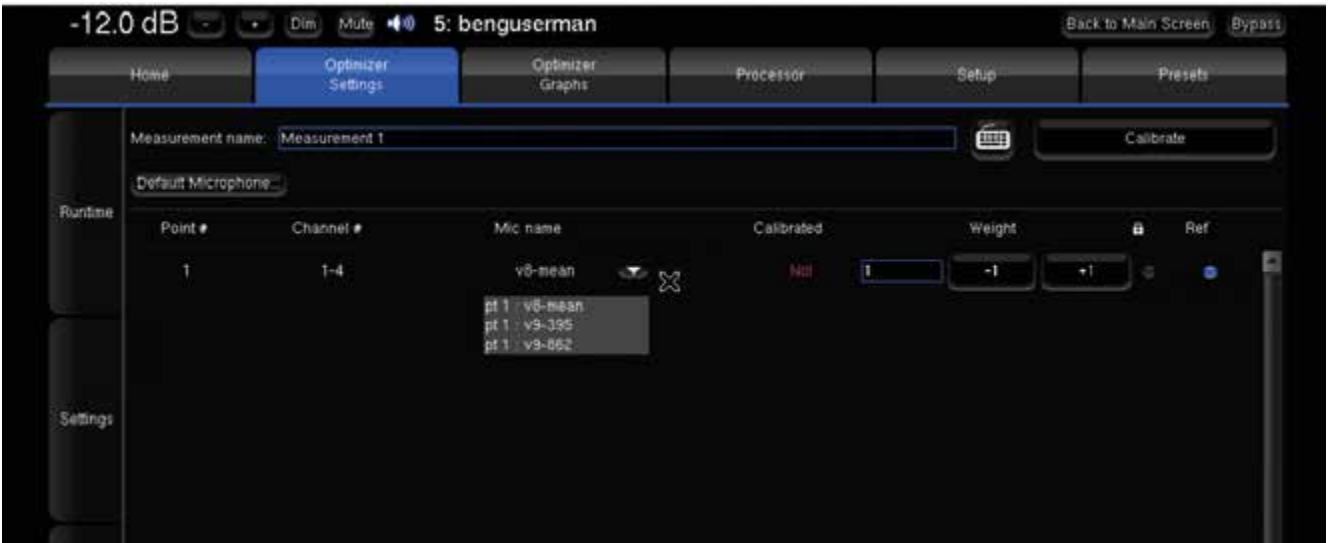

*Calibration page*

Always make sure the microphone serial number indicated in the Configure page matches the label at the bottom of your microphone. If not, use the Configure button of the required Measurement to select the correct compensation file.

For future measurements, use the Default Microphone button to make the required compensation file automatically selected in the preset.

The 3D localization of the speakers can only be performed if the connection order of the capsules is respected.

### 13.6.4 \_CONNECTION ORDER

THE INDIVIDUAL COMPENSATION FILE OF THE MICROPHONE USED BY THE ALTITUDE<sup>32</sup> CAN BE MODIFIED IN THE OPTIMIZER SETTINGS/CALIBRATION PAGE.

•Microphone with 5-Pins XLR

•Microphone with 4 XLR



•XLR 1      •XLR 2      •XLR 3      •XLR 4  
•CONNECTION ORDER

Always make sure the microphone serial number indicated in the Configure page matches the label at the bottom of your microphone. If not, use the Configure button of the required Measurement to select the correct compensation file.

For future measurements, use the Default Microphone button to make the required compensation file automatically selected in the preset.

The 3D localization of the speakers can only be performed if the connection order of the capsules is respected.

Thank you for your attention.  
Enjoy your Altitude !

Trinnov Audio derives from "**Tri-innovation**", hence Innovation in 3D Audio. Our company's constant focus in this field of research has allowed us to develop the most advanced, innovative, powerful and scalable 3D AV Preamplifier ever manufactured.

Thanks to a unique hardware platform, Trinnov Audio offers the first implementations of the latest home theater audio technologies. The Altitude<sup>32</sup> has established a new leadership position within the luxury home cinema processors category, opening the way for a whole new generation of modern, scalable and software oriented home cinema processors.